

W1G200-HH77-52

EC axial compact fan

sickled blades (S series)



ebm-papst Mulfingen GmbH & Co. KG

Bachmühle 2 · D-74673 Mulfingen

Phone +49 7938 81-0

Fax +49 7938 81-110

info1@de.ebmpapst.com

www.ebmpapst.com

Limited partnership · Headquarters Mulfingen
County court Stuttgart · HRA 590344

General partner Elektrobau Mulfingen GmbH · Headquarters Mulfingen
County court Stuttgart · HRB 590142

Nominal data

Type	W1G200-HH77-52	
Motor	M1G074-BF	
Nominal voltage	VDC	24
Nominal voltage range	VDC	16 .. 28
Type of data definition		fa
Speed	min ⁻¹	2950
Power input	W	55
Current draw	A	2.6
Max. back pressure	Pa	120
Min. ambient temperature	°C	-25
Max. ambient temperature	°C	60

ml = Max. load · me = Max. efficiency · fa = Running at free air · cs = Customer specs · cu = Customer unit
Subject to alterations



Technical features

Mass	2.13 kg
Size	200 mm
Surface of rotor	Coated in black
Material of blades	Sheet steel, coated in black
Material of wall ring	Die-cast aluminium
Number of blades	9
Direction of air flow	"V"
Direction of rotation	Counter-clockwise, seen on rotor
Type of protection	IP 42
Insulation class	"B"
Humidity class	F0
Max. permissible ambient motor temp. (transp./ storage)	+ 80 °C
Min. permissible ambient motor temp. (transp./storage)	- 40 °C
Mounting position	Any
Condensate discharge holes	None
Operation mode	S1
Motor bearing	Ball bearing
Technical features	<ul style="list-style-type: none"> - Tach output - Motor current limit - Soft start - Control input 0-10 VDC / PWM
EMC interference immunity	Acc. to EN 61000-6-2 (industrial environment)
EMC interference emission	Acc. to EN 55022 (Class B)
Electrical leads	Via terminal strip
Motor protection	Reverse polarity and locked-rotor protection
Product conforming to standard	EN 60335-1
Approval	GOST; UL 1004-1; CSA C22.2 Nr.77

Product drawing

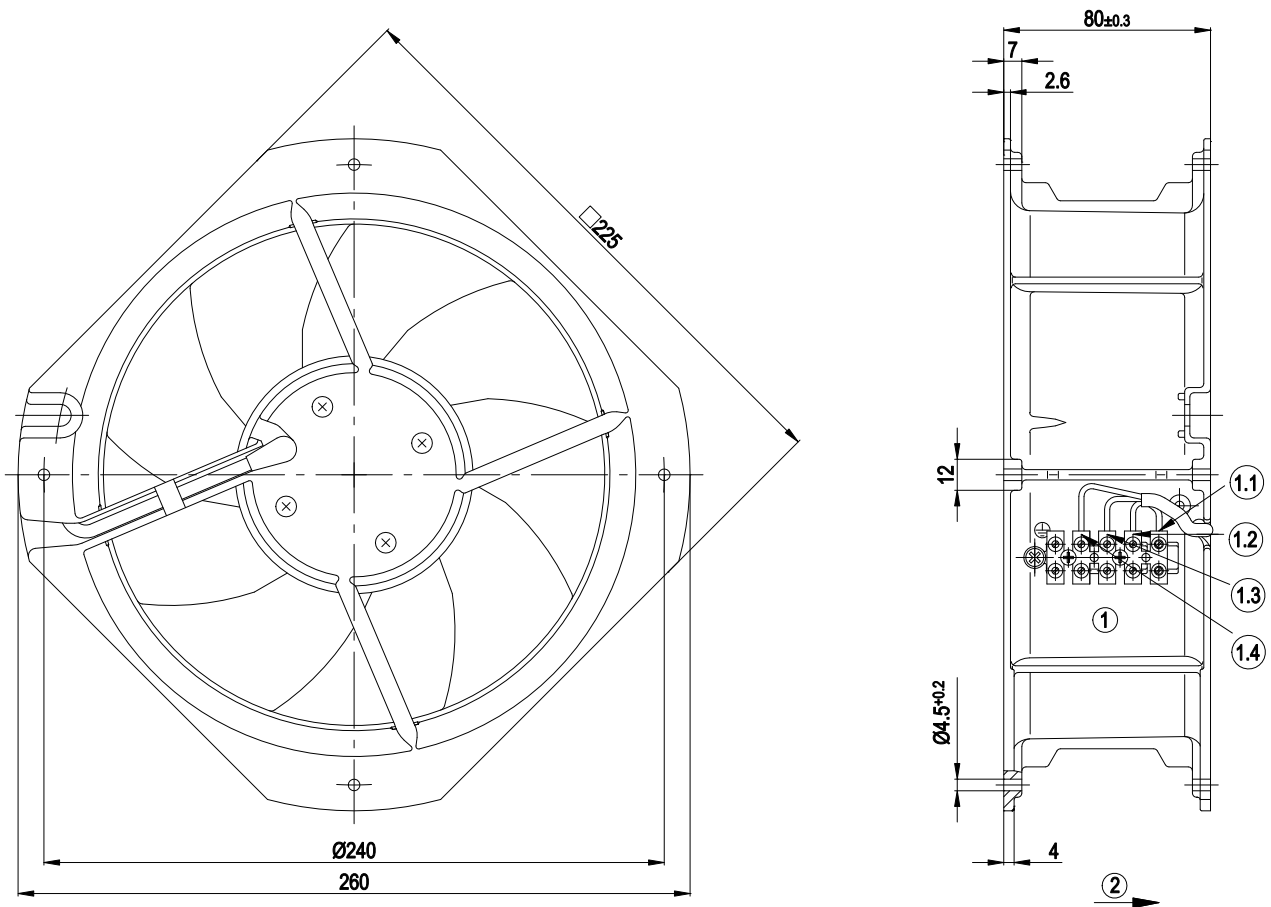

1	Connection: terminal strip with 5 terminals.
1.1	UN +24 VDC (red)
1.2	GND (blue)
1.3	DUE (white)
1.4	0-10 VDC (yellow)
2	Direction of air flow "V"

Connection screen

Customer circuit

Full speed

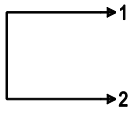

Adjustable speed

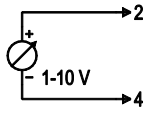

10 V → n = max
1 V → n = min
<1 V → n = 0
Safe start at
Unom -30%
from 4 V Ucontr.

Speed adjustable via potentiometer

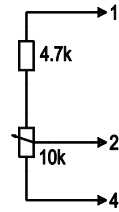

Speed adjustable via PWM 1-10 kHz

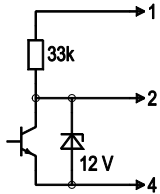

100% PWM → n = max
10% PWM → n = min
<10% PWM → n = 0
Safe start at
Unom -30%
from 40% PWM

Preset target value via temperature controller

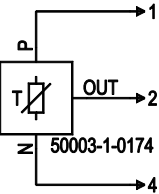

T < 10 °C → n = 0
T > 45 °C → n = max

Connection

Fan/Motor

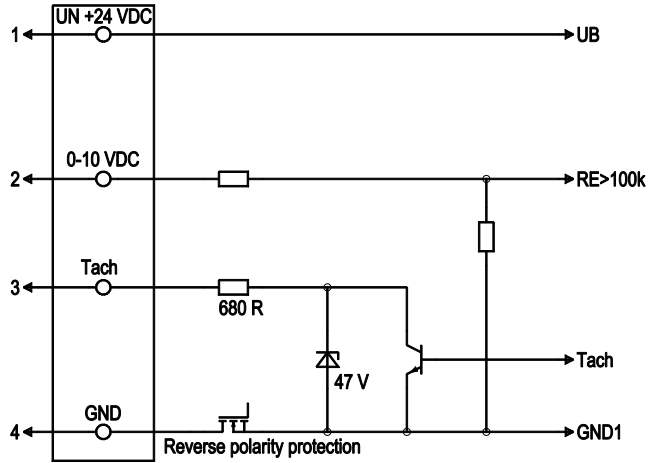

No.	Conn.	Designation	Colour	Function / assignment
1	1	Un +24 VDC	red	Power supply 24 VDC, residual ripple 3.5 %
1	2	0-10 VDC	yellow	Control input Re > 100 K
1	3	Tach	white	Speed monitoring output, 3 pulses per revolution, Isink max = 10 mA
1	4	GND	blue	Reference mass



Charts: Air flow

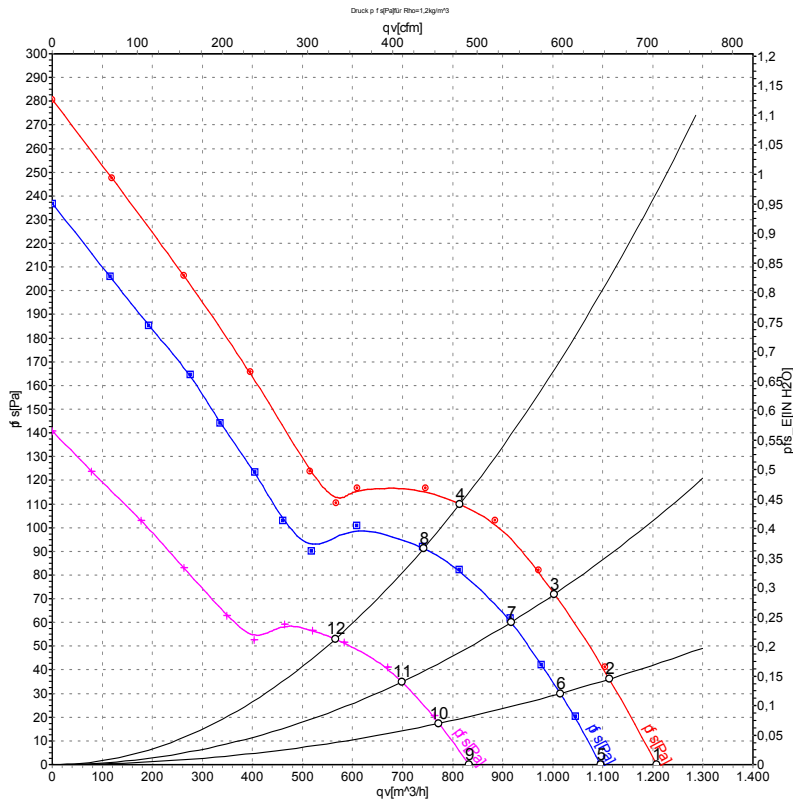

Air performance measured as per ISO 5801 Installation category A. For detailed information on the measuring set-up, please contact ebmpapst. Suction-side noise levels: LwA measured as per ISO 13347 / LpA measured with 1m distance to fan axis. The values given are valid under the measuring conditions mentioned above and may vary according to the actual installation situation. With any deviation from the standard set-up, the specific values have to be checked and reviewed with the unit installed.

Measured values

	U	n	P _{ed}	I	qv	p _{fs}
	V	min ⁻¹	W	A	m ³ /h	Pa
1	28	3285	73	2.91	1205	0
2	28	3190	76	3.01	1115	38
3	28	3095	78	3.10	1005	72
4	28	3065	82	3.26	815	110
5	24	2950	55	2.60	1095	0
6	24	2915	57	2.67	1015	30
7	24	2860	60	2.76	915	60
8	24	2785	62	2.88	740	90
9	16	2285	28	2.08	835	0
10	16	2245	28	2.09	770	18
11	16	2200	29	2.13	700	35
12	16	2145	30	2.18	565	53

U = Supply voltage · n = Speed · P_{ed} = Power input · I = Current draw · qv = Air flow · p_{fs} = Pressure increase

