

Indoor instrument transformers

Current transformers
Voltage transformers



Make the most of your energy

Instrument transformers 5



CTs: Current Transformers 9



LPCT: Electronic current
transformers 29



VTs: Voltage Transformers 33



Presentation	6
Applications and types	8



The Schneider Electric range of instrument transformers is designed for voltages from 0.72 kV to 36 kV and rated currents from 5 A to 4000 A.

In order to meet requirements for increasingly high short circuit current values in installations, current transformers notably have a short-time thermal current of 60 kA x 1 second.

All Schneider Electric instrument transformers are in conformity with IEC standards.

■ Current transformers can specifically meet requirements for:

□ accuracy classes "TPS - TPX - TPY - TPZ" defined by standards IEC 60044-6 relative to recommendations concerning transformer behaviour during transient short circuit conditions

□ standard IEC 60079-7 / EN 50.019 concerning enhanced safety electrical equipment for explosive gaseous atmospheres

■ Through their standardized configuration, their high electrical performance levels, their reduced weight and space requirement, these devices are particularly well suited for use with:

- LSC2B type cubicles (metal clad)
- LSC2A type cubicles (compartmented)
- large motor terminals
- explosive gaseous atmosphere environments (Eex).

Conformity with standards

All Schneider Electric instrument transformers are in conformity with IEC standards, sections 2099 - 2134, and recommendations 60044-1/IEC 60044-2. Transformers in conformity with specific country standards can also be supplied (IEEE C57.13, NBR6855, NBR6856...).

Main features

The working parts (windings and magnetic cores) are entirely enclosed in an epoxy resin bloc casting whose twofold function is to:

- guarantee both internal and external electrical insulation of the device
- provide enhanced mechanical strength.

Product quality over time is guaranteed not only by thirty years experience in manufacturing resin insulated instrument transformers, but also by the use of **silica filled epoxy resin** which gives:

- high dielectric strength, even at high temperatures (18 kV/mm at 180°C for 20.000 hours)
- insulation class B according to IEC 60044-1
- high ageing resistance, both thermal, resulting from increase in temperature of structures according to IEC 216 (more than 20 years at 120°C), and surface through salt mist withstand
- lack of emissions of any harmful substances in the case of fire, in conformity with IEC standards IEC 60020-37, IEC 60020-22 and ASTM D 3286
- outstanding behaviour in tropical climates
- high mechanical strength, even at **high service: epoxy resin glass transition temperature $\geq 105^{\circ}\text{C}$.**

Rigorous production procedures enable:

- no blisters or blowholes in the resin thanks to vacuum casting
- a partial discharge value with a low time constant, also due to the quality of insulating materials used
- high resistance and very good electrical conductivity at the primary and secondary terminals, even at temperatures reached during short circuit, due to mechanical connections
- the consistency of production parameters over time, through a computer controlled system which manages and monitors the whole production line.

Quality is the result of scheduling and monitoring at each stage, from initial design through to production and testing, and right through to final delivery and after sales service.

This is expressed in terms of execution in conformity with the quality certification. This procedure allows us to supply a product that has all of the specified characteristics and also to provide the customer with a production and execution schedule that guarantees product quality.

Certified quality system

Schneider Electric's quality guarantee is certified in documents that are available on request:

- documents explaining the company's quality policy
- a schedule for each stage of each product's execution
- the continuous assessment of indicators checking all possible quality faults during the production process
- a set of technical/quality documents providing proof of what has happened throughout the production and testing processes so as to guarantee the required quality level.

The production process applies standardized methods for Quality Assurance and Control.

Quality Control plans ensure that the defined procedures are applied to the product, from testing through to delivery of equipment used in production right through to final production.

The initial phases of product design and industrialization are also subject to Quality Certification procedures.

The Schneider Electric quality system is certified by the CSQ

The CSQ (independent certification organization for quality management systems) has certified Schneider Electric's quality to be in conformity with IEC standard - EN 29001 (ISO 9001), which require a company to implement a comprehensive quality assurance system covering all aspects from product definition through to after sales service.



Protection or metering devices have to receive data on electrical values (current or voltage) from the equipment to be protected. For technical, economic and safety reasons, this data cannot be obtained directly on the equipment's MV power supply; we have to use intermediary sensors:

- Current transformers
- Voltage transformers.

These devices carry out the functions of:

- Reducing the size of value to be measured
- Providing galvanic separation
- Supplying the power needed to process the data, or even for the protection device to work.

Metering transformer applications

In MV electrical distribution, the high current and voltage values mean that they cannot be used directly by metering or protection units.

Instrument transformers are necessary to provide values that can be used by these devices which can be:

- analogue devices, directly using the supplied signal
- digital processing units with a microprocessor, after analogue/digital conversion of the input signal (e.g.: Sepam or Power Logic System).

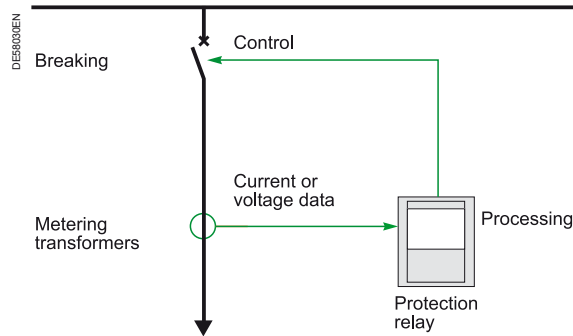

Example of a metering transformer application in a protection system

Types

Instrument transformers are of the following types:

Current transformers

Connected on the MV network primary circuit, they supply a reduced current value to the secondary circuit, proportional to the network current on which they are installed.

There are two types:

- CT: current transformer
- LPCT (Low Power Current Transformer): electronic current transformers.

Voltage transformers

Connected to the MV network primary, they supply the secondary circuit with a reduced voltage value, proportional to the network voltage on which they are installed.

Selection guide	10
Technical description	10
Using the order forms	16
<hr/>	
Order form	17
DIN standard 12 kV CT - single and double secondary	17
DIN standard 24 kV CT - single secondary	18
DIN standard 24 kV CT - double secondary	19
24 kV primary conductor support CT - single secondary	20
24 kV primary conductor support CT - double secondary	21
36 kV primary conductor support CT - single secondary	22
36 kV primary conductor support CT - double secondary	23
17.5 - 24 - 36 kV split-over CT - single and double secondary	24
0.72 kV closed core CT - single and double secondary	25
<hr/>	
Dimensions	26



Current transformers (CT) meet standard IEC 60044-1.

Their function is to supply the secondary circuit with a current that is proportional to that of the MV circuit on which they are installed.

The primary is series-mounted on the MV network and subject to the same over-currents as the latter and withstands the MV voltage.

The secondary generally has one of its terminals connected to earth.

The secondary must never be in an open circuit (short circuit).

Current transformers

Current transformers have two basic functions:

- adapting the MV current value at the primary to the characteristics of the metering or protection devices by supplying a secondary current with a reduced, but proportional current value
- isolating power circuits from the metering and/or protection circuit.

Composition and types

A current transformer comprises a primary circuit and a secondary circuit connected via a magnetic core and an insulating coating system in epoxy-silica, in the case of Schneider Electric transformers.

The device is of the following type:

- wound: when the primary and the secondary have a coil wound on the magnetic circuit
- slip-over: primary made up of a conductor that is not insulated from the installation
- core: primary made up of an insulated cable.

Characteristics

These are defined in standard IEC 60044-1.

Insulation

Characterized by the rated voltage:

- of the insulation, which is that of the installation (e.g.: 24 kV)
- of the power frequency withstand 1 min (e.g.: 50 kV)
- of the impulse withstand (e.g.: 125 kV).

Rated frequency

50 or 60 Hz.

Rated primary current (I_{pn})

Rms value of the maximum continuous primary current. Usual values are 25, 50, 75, 100, 200, 400, 600 A.

Rated secondary current (I_{sn})

This is equal to 1 A or 5 A.

Rated transformation ratio

$K_n = I_{\text{rated primary}} / I_{\text{rated secondary}}$ (e.g.: 100 A / 5 A)

Short-time thermal current I_{th} - 1 second

This characterizes the thermal withstand under short circuit conditions for 1 second. It is expressed in kA or in a multiple of the rated primary current (e.g.: 80 x I_{pn}) for 1 second.

The value for a duration that is different to 1 second is given by:

$$I'_{th} = I_{th} / \sqrt{2}$$

For example 16 kA - 1 s is equivalent for 2 s to $I'_{th} = 16 \times \sqrt{2} = 22.6$ kA.

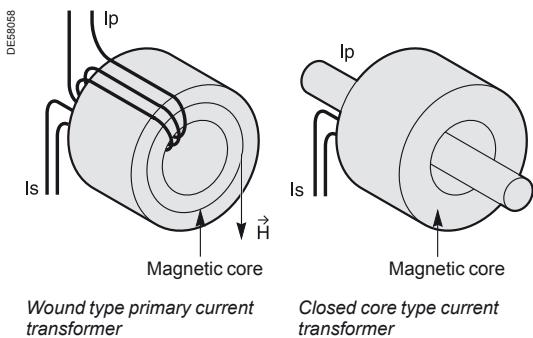

Wound type primary current transformer

Closed core type current transformer

Characteristics (cont.)

Short-time thermal current peak value

This value is standardized from $I_{th} - 1$ s at:

- IEC: 2.5 I_{th} at 50 Hz and 2.6 I_{th} at 60 Hz
- ANSI: 2.7 I_{th} 60 Hz.

Accuracy load

The value of the load on which is based the metered current accuracy conditions.

Accuracy power P_n

Apparent power (VA) that the CT can supply on the secondary for the rated secondary current for which the accuracy is guaranteed (accuracy load).

Usual values 5 - 7.5 - 10 - 15 VA (IEC).

Accuracy class

Defines the limits of error guaranteed on the transformation ratio and on the phase shift under the specified conditions of power and current. Classes **0.5** and **1** are used for metering class **P** for protection.

Current error ϵ (%)

Error that the transformer introduces in the measurement of a current when the transformation ratio is different from the rated value.

Phase shift or phase error ψ (minute)

Difference in phase between the primary and secondary currents, in angle minutes.

Table of current transformer characteristics

Characteristics	Rated values				
Rated voltage (kV)	7.2	12	17.5	24	36
Insulation level:					
■ power frequency withstand (kV) 1 min	20	28	38	50	70
■ lightning impulse withstand (kV - peak)	60	75	95	125	170
Frequency (Hz)	50 - 60				
Primary current I_{pn} (A)	25 - 50 - 75 - 100 - 200 - 400 - 600...				
Short-time thermal current I_{th} (1 s)	12.5 - 16 - 20 - 25 - 31.5 - 40 - 50 kA or 40 - 80 - 100 - 200 - 300 x I_n				
Secondary current I_{sn} (A)	1 - 5				
Accuracy power P_n (VA)	2.5 - 5 - 7.5 - 10 - 15				

The choice of CT is decisive in order for the overall metering or protection system to work properly.

CT operation

Importance of CT selection

The operating accuracy of metering or protection devices depends directly on the CT accuracy.

Operating principle

A CT often has a load that is quite resistive (R_c + its wiring), as shown in the schematic diagram below.

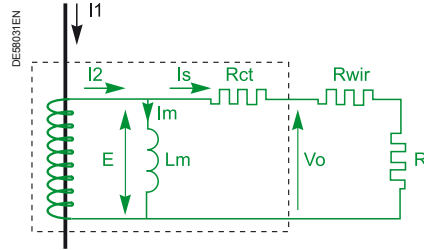

Schematic diagram for a current transformer

I_1 : primary current.

$I_2 = K_n I_1$: secondary current for a perfect CT.

I_s : secondary current actually flowing through the circuit.

I_m : magnetizing current.

E : induced electromotive force.

V_o : output voltage.

L_m : magnetization inductance (saturable) equivalent to the CT.

R_{ct} : resistance at the CT secondary.

R_{wir} : resistance of the connection wiring.

R_c : load resistance.

Current I_2 is a perfect image of the primary current I_1 in the transformation ratio. However, the actual output current (I_s) is subject to an error due to the magnetization current (I_m).

$$\vec{I}_2 = \vec{I}_s + \vec{I}_m$$

if the CT was perfect, we would have $I_m = 0$ and $I_s = I_2$.

A CT has a unique magnetization curve (for a given temperature and frequency). With the transformation ratio, this characterizes its operation.

This magnetization curve (voltage V_o , magnetizing current function I_m) can be divided into 3 zones:

- 1 - non-saturated zone: I_m is low and the voltage V_o (and therefore I_s) increases virtually proportionately to the primary current.
- 2 - intermediary zone: there is no real break in the curve and it is difficult to situate a precise point corresponding to the saturation voltage.
- 3 - saturated zone: the curve becomes virtually horizontal; the error in transformation ratio is high, the secondary current is distorted by saturation.

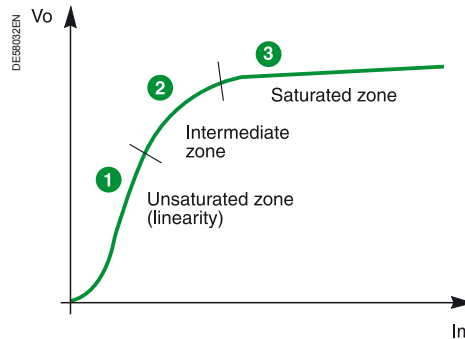

Magnetization curve (excitation) for a CT.

Output voltage as a function of the magnetizing current.

$$V_o = f(I_m)$$

Metering CT or protection CT

We have to choose a CT with characteristics that are suited to its application.

Metering CT

This requires good accuracy (linearity zone) in an area close to the **normal service current**; it must also protect metering devices from high currents by saturating earlier.

Protection CT

This requires good accuracy at **high currents** and will have a higher precision limit (linearity zone) for protection relays to detect the protection thresholds that they are meant to be monitoring.

Feasibility of a CT

We can define the over-current coefficient of the CT:

$$K_{si} = \frac{I_{th} I_s}{I_{pn}}$$

The lower K_{si} , the easier the CT is to produce with a given volume, compatible with being integrated in a MV cubicle. A high K_{si} leads to over-dimensioning of the CT and makes it difficult to produce.

Ksi order of magnitude	CT production
$K_{si} < 100$	Standard
$100 < K_{si} < 300$	Sometimes difficult for certain secondary characteristics
$300 < K_{si} < 400$	Difficult
$400 < K_{si} < 500$	Limited to certain secondary characteristics
$K_{si} > 500$	Sometimes impossible

Safety

The CT secondary is used at low impedance (virtually in short circuit).

The secondary circuit should never be left open, since this would mean connecting across an infinite impedance. Under these conditions, hazardous voltages for personnel and equipment may exist across the terminals.

Terminal marking

CT connection is made to the terminals identified according to the IEC:

- P1 and P2 on the MV side
- S1 and S2 on the corresponding secondary. In the case of a double output, the first output is identified by 1S1 and 1S2, the second by 2S1 and 2S2.

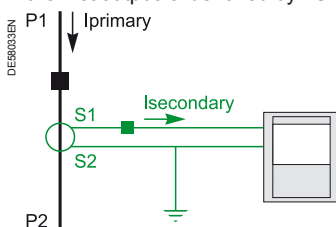

Current transformer showing the terminals

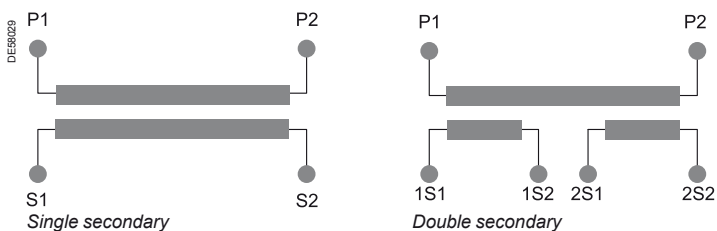

CT's for metering must have the right accuracy for the rated current. They are characterized by their accuracy class (generally 0.5 or 1) as well as a safety factor Fs.

Example: 400/5 A, 15 VA, cl 0.5, FS 10

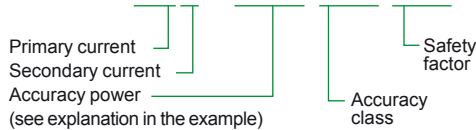

Accuracy class according to application

Application	Class
Laboratory measurement	0.1 - 0.2
Accurate metering (calibration devices)	
Industrial metering	0.5 - 1
Billing metering	0.2 - 0.5 - 0.2S - 0.5S
Switchboard indicators statistical metering	0.5 - 1

Error limits according to the accuracy class

Accuracy class	% rated primary current	Current error ± %		Phase shift error ± min	
		for S		for S	
0.2 / 0.2S	1 (0.2S alone)	0.75		30	
	5	0.75	0.35	30	15
	20	0.35	0.2	15	10
	100	0.2	0.2	10	10
	120	0.2	0.2	10	10
0.5 / 0.5S	1 (0.5S alone)	1.5		90	
	5	1.5	0.75	90	45
	20	0.75	0.5	45	30
	100	0.5	0.5	30	30
	120	0.5	0.5	30	30
1	5	3		180	
	20	1.5		90	
	100	1		60	
	120	1		60	

CT for metering

Accuracy class

A metering CT is designed to send as accurate an image as possible of currents below 120% of the rated primary. IEC standard 60044-1 determines the maximum error in the accuracy class for the phase and for the module according to the indicated operating range (see "error limits" table opposite).

These accuracy values must be guaranteed by the manufacturer for a secondary load of between 25 and 100% of the accuracy power.

The choice of accuracy class is related to the application (table opposite).

The usual accuracy class is 0.5. there are metering classes of 0.2S and 0.5S specifically for metering applications.

Safety factor: FS

In order to protect the metering device connected to the CT from high currents on the MV side, instrument transformers must have early saturation characteristics. The limit primary current (I_{pl}) is defined for which the current error in the secondary is equal to 10%. The standard then defines the Safety Factor FS.

$$FLP = \frac{I_{pl}}{I_p n} \text{ (preferred value: 10)}$$

This is the multiple of the rated primary current from which the error becomes greater than 10% for a load equal to the accuracy power.

Example of a metering CT

Metering CT **200/5 A, 15 VA, cl. 0.5, FS 10**

- rated primary current 200 A
- rated secondary current 5 A
- rated transformation ratio 200/5 A
- accuracy power 15 VA
- accuracy class 0.5.
- safety factor FS = 10

For a primary current greater than 10 times the rated current, in other words here 2000 A, we will have a metering error > 10% if the load is equal to the accuracy load; for a load less than this we can still be in the linear part of the magnetization curve.

CT's for protection must have suitable accuracy for fault currents. They are characterized by their accuracy class (generally 5P) and the accuracy limit factor FLP.

Example: 400/5 A, 15 VA, 5P10

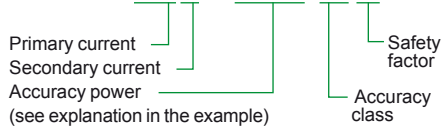

CT for protection

Accuracy class

A protection CT is designed to send as reliable an image as possible of the **fault current** (overload or short circuit). The accuracy and the power are suited to these currents and different from those for metering applications.

IEC standard 60044-1 determines the maximum error for each accuracy class in the phase and in the module according to the indicated operating range.

Error limits according to the accuracy class

Accuracy class	Combined error for the accuracy limit current	Current error between I_{pn} and $2I_{pn}$	Phase shift error for the rated current
5P	5%	± 1%	± 60 min
10P	10%	± 3%	No limit

For example for class 5P the maximum error is $\leq \pm 5\%$ at the accuracy limit current and $\leq \pm 1\%$ at the rated current.

Standardized classes are 5P and 10P. The choice depends on the application. The accuracy class is always followed by the accuracy limit factor.

Accuracy class according to application

Application	Class
Zero sequence protection	5P
Differential protection	
Impedance relay	5P - 10P
Amperemetric protection	

Accuracy limit factor: FLP

A protection CT must saturate at sufficiently high currents to enable sufficient accuracy in the measurements of fault currents by the protection device whose operating threshold can be very high.

We define the limit primary current (I_{pl}) for which current errors and phase shift errors in the secondary do not exceed values in the table opposite.

The standard then defines the accuracy limit factor FLP.

$$FLP = \frac{I_{pl}}{I_{pn}} \quad (\text{standardized values: } 5 - 10 - 15 - 20 - 30)$$

In practice this corresponds to the linearity limit (saturation curve) of the CT.

Example

Protection CT: **100/5 A, 7.5 VA, 5P20.**

- rated primary current 100 A
- rated secondary current 5 A
- rated transformation ratio 100/5 A
- accuracy power 7.5 VA
- accuracy class 5P.

Under a load corresponding to the accuracy power of 7.5 VA, the error limit table gives an error $\leq \pm 1\%$ and ± 60 min at I_{pn} (100 A).

- accuracy limit factor 20.

At a load corresponding to the accuracy power, the error $\leq \pm 5\%$.

Selection guide

Using the order forms

The tables on the following pages allow you to define the current transformer reference that corresponds to the necessary and required characteristics, and to place your order.

The selection factors enabling you to find the reference you require are explained in the example given below for a DIN type metering CT, in reference to the previous definitions.

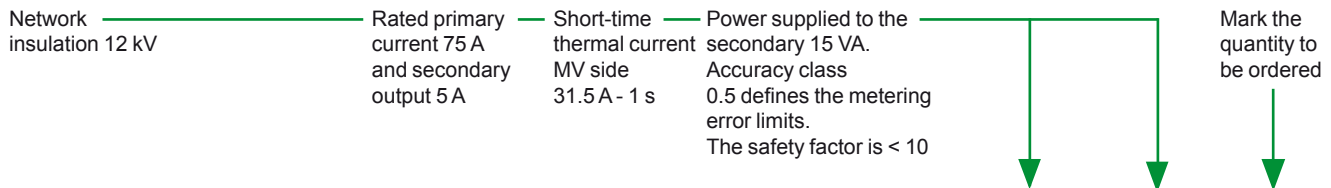

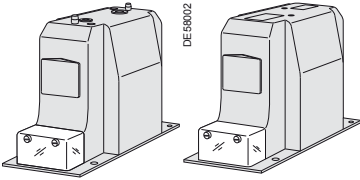
Insulation level and frequency	Transformation ratio A / A	Short-time thermal current kA x 1 s	Power, accuracy class, safety factor FS	Type	Reference	Quantity	
Ur 12 kV Ud 28 kV - 1 min Up 75 kV peak fr 50/60 Hz  AD12N1 AD13N1 Dimensions page 26	50 / 5	12.5	15 VA cl. 0.5 Fs < 10	AD12	03811366N0		
		16		AD12	03811368N0		
		25		AD12	03811371N0		
	75 / 5	31.5		AD12	03811373N0		
		25		AD12	03811376N0		
		31.5		AD12	03811378N0		
	200 / 5	25		AD12	03811380N0		
		31.5		AD12	03811382N0		
		40		AD12	03811384N0		
	400 / 5	40		20 VA cl. 0.5 Fs < 10	AD12	03811386N0	
		50			AD12	03811388N0	
		50			AD12	03811390N0	
	1000 / 5	50		30 VA cl. 0.5 Fs < 10	AD13	03811392N0	
		50			AD13	03811394N0	

Calculating the power (VA)

Indicative metering consumptions

Device		Max. consumption in VA (per circuit)
Ammeter	Electromagnetic	3
	Electronic	1
Transducer	Self-powered	3
	External powered	1
Meter	Induction	2
	Electronic	1
	Wattmeter, varmeter	1

Indicative protection consumption

Device	Max. consumption in VA (per circuit)
Static over-current relay	0.2 to 1
Electromagnetic over-current relay	1 to 8

Indicative secondary cabling consumption

Cables (mm ²)	Consumption (VA/m)	
	1 A	5 A
2.5	0.008	0.2
4	0.005	0.13
6	0.003	0.09
10	0.002	0.05

Order form

DIN standard 12 kV CT - single and double secondary

Single secondary metering CT

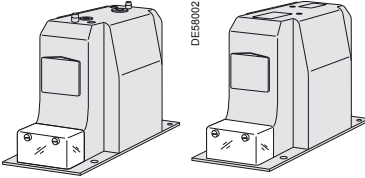
Insulation level and frequency	Transformation ratio A / A	Short-time thermal current kA x 1 s	Power, accuracy class, safety factor FS	Type	Reference	Qty
Ur 12 kV Ud 28 kV - 1 min Up 75 kV peak fr 50/60 Hz  AD12 AD13 Dimensions page 26	50 / 5	12.5	15 VA cl. 0.5 Fs < 10	AD12/N1	03811366N0	
		16		AD12/N1	03811368N0	
		25		AD12/N1	03811371N0	
	75 / 5	31.5		AD12/N1	03811373N0	
		25		AD12/N1	03811376N0	
		31.5		AD12/N1	03811378N0	
	100 / 5	25		AD12/N1	03811380N0	
		31.5		AD12/N1	03811382N0	
	200 / 5	40		AD12/N1	03811384N0	
		40		AD12/N1	03811386N0	
	400 / 5	40	20 VA cl. 0.5 Fs < 10	AD12/N1	03811388N0	
	600 / 5	50		AD12/N1	03811390N0	
	750 / 5	50		AD13/N1	03811392N0	
	1000 / 5	50	30 VA cl. 0.5 Fs < 10	AD13/N1	03811394N0	
	1250 / 5	50		AD13/N1		

Single secondary protection CT

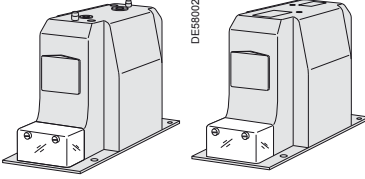
Insulation level and frequency	Transformation ratio A / A	Short-time thermal current kA x 1 s	Power and accuracy class (possible double use)	Type	Reference	Qty
Ur 12 kV Ud 28 kV - 1 min Up 75 kV peak fr 50/60 Hz  AD12 AD13 Dimensions page 26	50 / 5	12.5	15 VA 5P10 - 7.5 VA 5P20	AD12/N1	03811367N0	
		16		AD12/N1	03811369N0	
		25	7.5 VA 5P10	AD12/N1	03811370N0	
	75 / 5	25	15 VA 5P10 - 7.5 VA 5P20	AD12/N1	03811372N0	
		31.5		7.5 VA 5P10	AD12/N1	03811374N0
		40	AD12/N1	03811375N0		
	100 / 5	25	15 VA 5P10 - 7.5 VA 5P20	AD12/N1	03811377N0	
		31.5		AD12/N1	03811379N0	
	200 / 5	40	7.5 VA 5P10	AD12/N1	03811839N0	
		40		AD12/N1	03811838N0	
		25	15 VA 5P10 - 7.5 VA 5P20	AD12/N1	03811381N0	
	400 / 5	31.5		AD12/N1	03811383N0	
		40		AD12/N1	03811385N0	
	600 / 5	40		AD12/N1	03811387N0	
	750 / 5	50		AD12/N1	03811389N0	
1000 / 5	50	10 VA 5P20	AD13/N1	03811393N0		
1250 / 5	50		AD13/N1	03811395N0		

Double secondary metering and protection CT

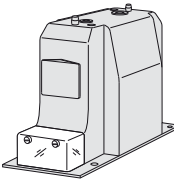
Insulation level and frequency	Transformation ratio A / A	Short-time thermal current kA x 1 s	Metering secondary: power, accuracy class, safety factor FS	Metering secondary: power and accuracy class (possible double use)	Type	Reference	Qty
Ur 12 kV Ud 28 kV - 1 min Up 75 kV peak fr 50/60 Hz  AD12 Dimensions page 26	50 / 5-5	12.5	7.5 VA cl. 0.5 Fs < 10	7.5 VA 5P10	AD12/N2	03811396N0	
		16			AD12/N2	03811397N0	
	75 / 5-5	16			AD12/N2	03811398N0	
		25			AD12/N2	03811399N0	
	100 / 5-5	25			AD12/N2	03811400N0	
		31.5	AD12/N2	03811401N0			
	200 / 5-5	25	15 VA cl. 0.5 Fs < 10	15 VA 5P10 - 7.5 VA 5P20	AD12/N2	03811402N0	
		31.5			AD12/N2	03811403N0	
	400 / 5-5	40	7.5 VA cl. 0.5 Fs < 10	7.5 VA 5P10	AD12/N2	03811404N0	
		40	15 VA cl. 0.5 Fs < 10	15 VA 5P10 - 7.5 VA 5P20	AD12/N2	03811405N0	
	600 / 5-5	50	20 VA cl. 0.5 Fs < 10		AD12/N2	03811406N0	
	750 / 5-5	50			AD12/N2	03811407N0	
	1000 / 5-5	50	30 VA cl. 0.5 Fs < 10	10 VA 5P20	AD13/N2	03811408N0	
	1250 / 5-5	50			AD13/N2	03811409N0	

Order form

DIN standard 24 kV CT - single secondary

Single secondary metering CT

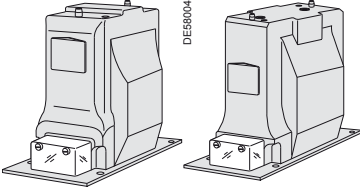
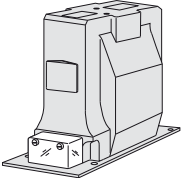
Insulation level and frequency	Transformation ratio A / A	Short-time thermal current kA x 1 s	Power, accuracy class, safety factor FS	Type	Reference	Qty
Ur 24 kV Ud 50 kV - 1 min Up 125 kV peak fr 50/60 Hz  AD21 AD22  AD23 Dimensions page 26	25 / 5	16	15 VA cl. 0.5 Fs < 10	AD22/N1	03811410N0	
		20		AD22/N1	03811413N0	
	50 / 5	20		AD21/N1	03811416N0	
		20		AD22/N1	03811419N0	
		20		AD22/N1	03811421N0	
		20		AD21/N1	03811424N0	
	75 / 5	16		AD21/N1	03811427N0	
		25		AD21/N1	03811430N0	
		31.5		AD22/N1	03811433N0	
		40		AD21/N1	03811436N0	
		25	AD21/N1	03811439N0		
		31.5	AD22/N1	03811442N0		
	100 / 5	40	AD21/N1	03811445N0		
		25	AD21/N1	03811447N0		
		31.5	AD21/N1	03811450N0		
	200 / 5	40	AD21/N1	03811453N0		
		50	AD21/N1	03811456N0		
	20 VA cl. 0.5 Fs < 10 30 VA cl. 0.5 Fs < 10	600 / 5	50	AD21/N1	03811459N0	
		750 / 5	50	AD21/N1	03811462N0	
		1000 / 5	50	AD21/N1	03811465N0	
1250 / 5		50	AD23/N1	03811468N0		
1500 / 5		50	AD23/N1	03811471N0		
2000 / 5		50	AD23/N1	03811474N0		
2500 / 5		50	AD23/N1	03811477N0		

Single secondary protection CT

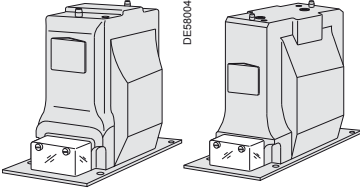
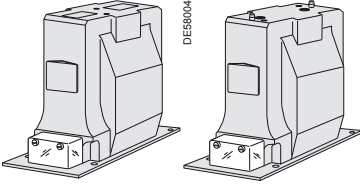
Insulation level and frequency	Transformation ratio A / A	Short-time thermal current kA x 1 s	Power and accuracy class (possible double use)	Type	Reference	Qty
Ur 24 kV Ud 50 kV - 1 min Up 125 kV peak fr 50/60 Hz  AD21 AD22  AD23 ARJD Dimensions page 26	25 / 5	16	7.5 VA 5P10	AD22/N1	03811411N0	
		16	15 VA 5P10 - 7.5 VA 5P20	ARJD/N1	03811412N0	
	50 / 5	20	7.5 VA 5P10	AD22/N1	03811414N0	
		20	15 VA 5P10 - 7.5 VA 5P20	ARJD/N1	03811415N0	
		20	7.5 VA 5P10	AD21/N1	03811417N0	
		16	15 VA 5P10 - 7.5 VA 5P20	AD22/N1	03811418N0	
		20		AD22/N1	03811420N0	
		20		ARJD/N1	03811422N0	
		20	7.5 VA 5P10	ARJD/N1	03811423N0	
		16	AD21/N1	03811425N0		
		16	15 VA 5P10 - 7.5 VA 5P20	AD22/N1	03811426N0	
		25	7.5 VA 5P10	AD21/N1	03811428N0	
	75 / 5	25	15 VA 5P10 - 7.5 VA 5P20	AD22/N1	03811429N0	
		31.5	7.5 VA 5P10	AD21/N1	03811431N0	
		31.5	15 VA 5P10 - 7.5 VA 5P20	AD22/N1	03811432N0	
		40	7.5 VA 5P10	AD22/N1	03811434N0	
		40	15 VA 5P10 - 7.5 VA 5P20	ARJD/N1	03811435N0	
		25	7.5 VA 5P10	AD21/N1	03811437N0	
		25	15 VA 5P10 - 7.5 VA 5P20	AD22/N1	03811438N0	
		31.5	7.5 VA 5P10	AD21/N1	03811440N0	
31.5		15 VA 5P10 - 7.5 VA 5P20	AD22/N1	03811441N0		
200 / 5		25	AD21/N1	03811444N0		
7.5 VA 5P10 15 VA 5P10 - 7.5 VA 5P20 10 VA 5P20 15 VA 5P20	31.5	AD21/N1	03811446N0			
	40	AD21/N1	03811448N0			
	40	15 VA 5P10 - 7.5 VA 5P20	AD22/N1	03811449N0		
	40	AD21/N1	03811451N0			
	50	AD21/N1	03811453N0			
	50	AD21/N1	03811455N0			
	50	AD21/N1	03811457N0			
	50	AD23/N1	03811459N0			
	50	AD23/N1	03811461N0			
	50	AD23/N1	03811463N0			
2500 / 5	50	AD23/N1	03811465N0			

Order form

DIN standard 24 kV CT - double secondary

Double secondary metering and protection CT

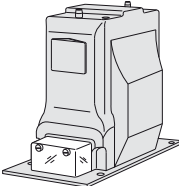
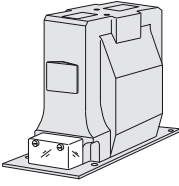
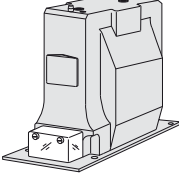
Insulation level and frequency	Transformation ratio A / A	Short-time thermal current kA x 1 s	Metering secondary: power, accuracy class, safety factor FS	Metering secondary: power and accuracy class (possible double use)	Type	Reference	Qty	
Ur 24 kV Ud 50 kV - 1 min Up 125 kV peak fr 50/60 Hz DE58003  AD21 DE58005  AD23 DE58004 	25 / 5-5	16	7.5 VA cl. 0.5 Fs < 10	7.5 VA 5P10	AD22/N2	03811466N0		
		20			ARJD/N2	03811467N0		
	50 / 5-5	16	15 VA cl. 0.5 Fs < 10	7.5 VA 5P10	AD21/N2	03811468N0		
		16			ARJD/N2	03811469N0		
		25	15 VA 5P10 - 7.5 VA 5P20	AD22/N2	03811470N0			
		25		ARJD/N2	03811471N0			
		75 / 5-5	31.5	7.5 VA cl. 0.5 Fs < 10	7.5 VA 5P10	ARJD/N2	03811472N0	
			16	15 VA cl. 0.5 Fs < 10	15 VA 5P10 - 7.5 VA 5P20	AD21/N2	03811473N0	
	25		7.5 VA cl. 0.5 Fs < 10	7.5 VA 5P10	AD22/N2	03811475N0		
	31.5				ARJD/N2	03811476N0		
	100 / 5-5		40	7.5 VA cl. 0.5 Fs < 10	7.5 VA 5P10	ARJD/N2	03811477N0	
			25	15 VA cl. 0.5 Fs < 10	15 VA 5P10 - 7.5 VA 5P20	AD21/N2	03811478N0	
		31.5	7.5 VA cl. 0.5 Fs < 10	7.5 VA 5P10	AD21/N2	03811479N0		
		31.5	15 VA cl. 0.5 Fs < 10	15 VA 5P10 - 7.5 VA 5P20	AD22/N2	03811480N0		
		40	7.5 VA cl. 0.5 Fs < 10	7.5 VA 5P10	AD22/N2	03811481N0		
		40	15 VA cl. 0.5 Fs < 10	15 VA 5P10 - 7.5 VA 5P20	ARJD/N2	03811482N0		
	200 / 5-5	31.5	7.5 VA cl. 0.5 Fs < 10	7.5 VA 5P10	AD21/N2	03811483N0		
		40			AD21/N2	03811484N0		
		40	7.5 VA cl. 0.5 Fs < 10	7.5 VA 5P10	AD21/N2	03811485N0		
		40	15 VA cl. 0.5 Fs < 10	15 VA 5P10 - 7.5 VA 5P20	AD22/N2	03811486N0		
400 / 5-5		40	20 VA cl. 0.5 Fs < 10		AD21/N2	03811487N0		
		600 / 5-5			AD21/N2	03811488N0		
	750 / 5-5	40	30 VA cl. 0.5 Fs < 10	AD21/N2	03811489N0			
	1000 / 5-5	40		AD23/N2	03811490N0			
	1250 / 5-5	40		AD23/N2	03811491N0			
	1500 / 5-5	40		AD23/N2	03811492N0			
2000 / 5-5	40	AD23/N2	03811493N0					
2500 / 5-5	40	AD23/N2	03811494N0					

ARJD
 Dimensions page 26

Order form

24 kV primary conductor support CT - single secondary

Single secondary metering CT

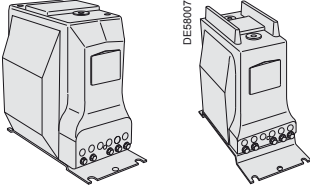
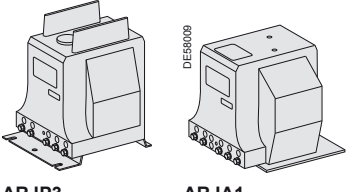
Insulation level and frequency	Transformation ratio A / A	Short-time thermal current kA x 1 s	Power, accuracy class, safety factor FS	Type	Reference	Qty	
Ur 24 kV Ud 50 kV - 1 min Up 125 kV peak fr 50/60 Hz  ARJM2 ARJP1  ARJP3 ARJA1 Dimensions page 27	25 / 5	16	15 VA cl. 0.5 Fs < 10	ARJM2/N1J	03811495N0		
		25		ARJM2/N1J	03811498N0		
		50 / 5		16	ARJP1/N1J	03811501N0	
				25	ARJM2/N1J	03811504N0	
				31.5	ARJM2/N1J	03811507N0	
		75 / 5		25	ARJP1/N1J	03811510N0	
				31.5	ARJP1/N1J	03811513N0	
				40	ARJM2/N1J	03811516N0	
				40	ARJP1/N1J	03811519N0	
		100 / 5		31.5	ARJP1/N1J	03811522N0	
	40		ARJM2/N1J	03811525N0			
	40		ARJP1/N1J	03811526N0			
	200 / 5	31.5	ARJP1/N1J	03811528N0			
		40	ARJP1/N1J	03811530N0			
	400 / 5	40	ARJP1/N1J	03811533N0			
	600 / 5	50	20 VA cl. 0.5 Fs < 10	ARJP1/N1J	03811535N0		
		50		ARJP1/N1J	03811537N0		
		50		30 VA cl. 0.5 Fs < 10	ARJP3/N1J	03811539N0	
		50			ARJP3/N1J	03811541N0	
		50			ARJA1/N1J	03811543N0	
2000 / 5		50		ARJA1/N1J	03811545N0		
2500 / 5		50		ARJA1/N1J	03811547N0		

Single secondary protection CT

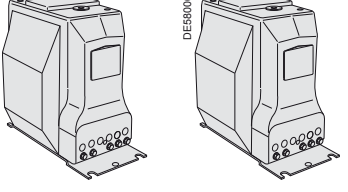
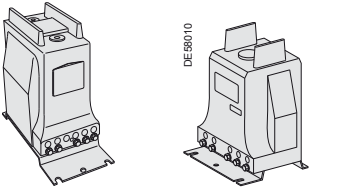
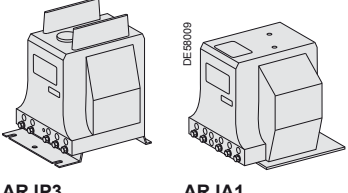
Insulation level and frequency	Transformation ratio A / A	Short-time thermal current kA x 1 s	Power and accuracy class (possible double use)	Type	Reference	Qty	
Ur 24 kV Ud 50 kV - 1 min Up 125 kV peak fr 50/60 Hz  ARJM2 ARJH  ARJP1 ARJP2  ARJP3 ARJA1 Dimensions page 27	25 / 5	16	7.5 VA 5P10	ARJM2/N1J	03811496N0		
		16	15 VA 5P10 - 7.5 VA 5P20	ARJH/N1J	03811497N0		
		25	7.5 VA 5P10	ARJM2/N1J	03811499N0		
		50 / 5	25	15 VA 5P10 - 7.5 VA 5P20	ARJH/N1J	03811500N0	
			16	7.5 VA 5P10	ARJP1/N1J	03811502N0	
			16	15 VA 5P10 - 7.5 VA 5P20	ARJP2/N1J	03811503N0	
			25	7.5 VA 5P10	ARJP2/N1J	03811505N0	
		75 / 5	25	15 VA 5P10 - 7.5 VA 5P20	ARJM2/N1J	03811506N0	
			31.5	7.5 VA 5P10	ARJH/N1J	03811508N0	
			40	7.5 VA 5P10	ARJH/N1J	03811509N0	
	100 / 5		25	7.5 VA 5P10	ARJP1/N1J	03811511N0	
			25	15 VA 5P10 - 7.5 VA 5P20	ARJP2/N1J	03811512N0	
			31.5	7.5 VA 5P10	ARJP2/N1J	03811514N0	
			31.5	15 VA 5P10 - 7.5 VA 5P20	ARJM2/N1J	03811515N0	
	200 / 5	40	7.5 VA 5P10	ARJP2/N1J	03811517N0		
		40	15 VA 5P10 - 7.5 VA 5P20	ARJH/N1J	03811518N0		
		25	7.5 VA 5P10	ARJP1/N1J	03811520N0		
		25	15 VA 5P10 - 7.5 VA 5P20	ARJP2/N1J	03811521N0		
		31.5	7.5 VA 5P10	ARJP1/N1J	03811523N0		
		31.5	15 VA 5P10 - 7.5 VA 5P20	ARJP2/N1J	03811524N0		
		40	7.5 VA 5P10	ARJP2/N1J	03811840N0		
	400 / 5	40	15 VA 5P10 - 7.5 VA 5P20	ARJH/N1J	03811841N0		
		31.5		ARJP1/N1J	03811527N0		
		40		ARJP1/N1J	03811529N0		
		40	7.5 VA 5P10	ARJP1/N1J	03811531N0		
		40	15 VA 5P10 - 7.5 VA 5P20	ARJP2/N1J	03811532N0		
		40		ARJP1/N1J	03811534N0		
		50		ARJP1/N1J	03811536N0		
		50		ARJP1/N1J	03811538N0		
		50	10 VA 5P20	ARJP3/N1J	03811540N0		
50			ARJP3/N1J	03811542N0			
1000 / 5	50	15 VA 5P20	ARJA1/N1J	03811544N0			
	50		ARJA1/N1J	03811546N0			
	50		ARJA1/N1J	03811548N0			
	50						

Order form

24 kV primary conductor support CT - double secondary

Double secondary metering and protection CT

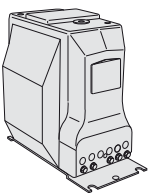
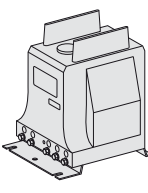
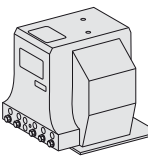
Insulation level and frequency	Transformation ratio A / A	Short-time thermal current kA x 1 s	Metering secondary: power, accuracy class, safety factor FS	Metering secondary: power and accuracy class (possible double use)	Type	Reference	Qty		
Ur 24 kV Ud 50 kV - 1 min Up 125 kV peak fr 50/60 Hz  ARJH  ARJP2  ARJM2  ARJP3 ARJA1 Dimensions page 27	25 / 5-5	12.5	7.5 VA cl. 0.5 Fs < 10	7.5 VA 5P10	ARJH/N2J	03811549N0			
		20			ARJH/N2J	03811550N0			
	50 / 5-5	16	15 VA cl. 0.5 Fs < 10	7.5 VA 5P10	ARJP2/N2J	03811551N0			
		16			ARJM2/N2J	03811552N0			
		25			ARJP2/N2J	03811553N0			
		25			ARJH/N2J	03811554N0			
		31.5			ARJH/N2J	03811555N0			
	75 / 5-5	16	15 VA cl. 0.5 Fs < 10	7.5 VA 5P10	ARJP2/N2J	03811556N0			
		16			ARJM2/N2J	03811557N0			
		25			ARJP2/N2J	03811558N0			
		25			ARJM2/N2J	03811559N0			
		31.5			ARJP2/N2J	03811560N0			
		31.5			ARJH/N2J	03811561N0			
		40			ARJH/N2J	03811562N0			
		40			ARJP2/N2J	03811563N0			
	100 / 5-5	25	15 VA cl. 0.5 Fs < 10	7.5 VA 5P10	ARJM2/N2J	03811564N0			
		25			ARJP2/N2J	03811565N0			
		31.5			ARJH/N2J	03811566N0			
		31.5			ARJP2/N2J	03811567N0			
		40			ARJH/N2J	03811568N0			
	200 / 5-5	40	15 VA cl. 0.5 Fs < 10	15 VA 5P10 - 7.5 VA 5P20	ARJP2/N2J	03811569N0			
		31.5			ARJP2/N2J	03811570N0			
	400 / 5-5	40	7.5 VA cl. 0.5 Fs < 10	7.5 VA 5P10	ARJP2/N2J	03811571N0			
		40			ARJH/N2J	03811572N0			
40		ARJP2/N2J			03811573N0				
600 / 5-5		40			20 VA cl. 0.5 Fs < 10	ARJP2/N2J	03406314F0		
750 / 5-5		40				ARJP2/N2J	03406332F0		
1000 / 5-5		50			30 VA cl. 0.5 Fs < 10	10 VA 5P20	ARJP3/N2J	03406333F0	
		50					ARJP3/N2J	03406315F0	
1500 / 5-5		50			15 VA 5P20	ARJA1/N2J	03406335F0		
2000 / 5-5		50				ARJA1/N2J	03406336F0		
2500 / 5-5		50				ARJA1/N2J	03406337F0		
	50	ARJA1/N2J	03406337F0						

Order form

36 kV primary conductor support CT - single secondary

Single secondary metering CT

Insulation level and frequency	Transformation ratio A / A	Short-time thermal current kA x 1 s	Power, accuracy class, safety factor FS	Type	Reference	Qty	
Ur 36 kV Ud 70 kV - 1 min Up 170 kV peak fr 50/60 Hz	25 / 5	16	15 VA cl. 0.5 Fs < 10	ARM6T/N1	03811574N0		
		20		ARM6T/N1	03811577N0		
	50 / 5	16		ARM6T/N1	03811580N0		
		25		ARM6T/N1	03811582N0		
		31.5		ARM6T/N1	03811584N0		
	75 / 5	25		ARM6T/N1	03811588N0		
		31.5		ARM6T/N1	03811590N0		
		40		ARM6T/N1	03811592N0		
	100 / 5	25		ARM6T/N1	03811595N0		
		31.5		ARM6T/N1	03811597N0		
		40	ARM6T/N1	03811599N0			
	200 / 5	25	ARM6T/N1	03811602N0			
		31.5	ARM6T/N1	03811604N0			
		40	ARM6T/N1	03811606N0			
	400 / 5	40	ARM6T/N1	03811608N0			
		40	20 VA cl. 0.5 Fs < 10	ARM6T/N1	03811610N0		
	600 / 5	40		ARM6T/N1	03811612N0		
	Ur 36 kV Ud 70 kV - 1 min Up 170 kV peak fr 50/60 Hz	1000 / 5	40	30 VA cl. 0.5 Fs < 10	ARM9T/N1	03811614N0	
		1250 / 5	40		ARM9T/N1	03811616N0	
		1500 / 5	40		ARM9T/N1	03811618N0	
2000 / 5		40	ARM9T/N1		03811620N0		
2500 / 5		40	ARM9T/N1		03811622N0		
2500 / 5		40	ARM9T/N1		03811622N0		

DES8011

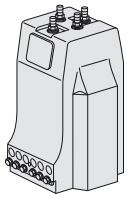

ARM6T

Dimensions page 28

DES8012

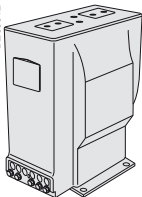

ARM9T

Single secondary protection CT

Insulation level and frequency	Transformation ratio A / A	Short-time thermal current kA x 1 s	Power and accuracy class (possible double use)	Type	Reference	Qty
Ur 36 kV Ud 70 kV - 1 min Up 170 kV peak fr 50/60 Hz	25 / 5	16	7.5 VA 5P10	ARM6T/N1	03811575N0	
		16	15 VA 5P10 - 7.5 VA 5P20	ARM9T/N1	03811576N0	
		20	7.5 VA 5P10	ARM6T/N1	03811578N0	
		20	15 VA 5P10 - 7.5 VA 5P20	ARM9T/N1	03811579N0	
	50 / 5	16		ARM6T/N1	03811581N0	
		25		ARM6T/N1	03811583N0	
		31.5	7.5 VA 5P10	ARM6T/N1	03811585N0	
		31.5	15 VA 5P10 - 7.5 VA 5P20	ARM9T/N1	03811586N0	
		40	7.5 VA 5P10	ARM9T/N1	03811587N0	
	75 / 5	25	15 VA 5P10 - 7.5 VA 5P20	ARM6T/N1	03811589N0	
		31.5		ARM6T/N1	03811591N0	
		40	7.5 VA 5P10	ARM6T/N1	03811593N0	
	100 / 5	40	15 VA 5P10 - 7.5 VA 5P20	ARM9T/N1	03811594N0	
		25		ARM6T/N1	03811596N0	
		31.5		ARM6T/N1	03811598N0	
		40	7.5 VA 5P10	ARM6T/N1	03811600N0	
	200 / 5	40	15 VA 5P10 - 7.5 VA 5P20	ARM9T/N1	03811601N0	
		25		ARM6T/N1	03811603N0	
		31.5		ARM6T/N1	03811605N0	
		40		ARM6T/N1	03811607N0	
400 / 5		40		ARM6T/N1	03811609N0	
600 / 5		40		ARM6T/N1	03811611N0	
Ur 36 kV Ud 70 kV - 1 min Up 170 kV peak fr 50/60 Hz	750 / 5	40		ARM6T/N1	03811613N0	
	1000 / 5	40	10 VA 5P20	ARM9T/N1	03811615N0	
	1250 / 5	40		ARM9T/N1	03811617N0	
	1500 / 5	40	15 VA 5P20	ARM9T/N1	03811619N0	
	2000 / 5	40		ARM9T/N1	03811621N0	
	2500 / 5	40		ARM9T/N1	03811623N0	
	2500 / 5	40		ARM9T/N1	03811623N0	
	2500 / 5	40		ARM9T/N1	03811623N0	

DES8011

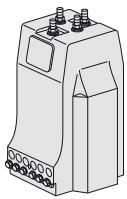

ARM6T

Dimensions page 28

DES8012

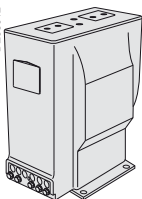

ARM9T

Order form

36 kV primary conductor support CT - double secondary

Double secondary metering and protection CT

Insulation level and frequency	Transformation ratio A / A	Short-time thermal current kA x 1 s	Metering secondary: power, accuracy class, safety factor FS	Metering secondary: power and accuracy class (possible double use)	Type	Reference	Qty		
Ur 36 kV Ud 70 kV - 1 min Up 170 kV peak fr 50/60 Hz	25 / 5-5	16	7.5 VA cl. 0.5 Fs < 10	7.5 VA 5P10	ARM6T/N2	03811624N0			
		20			ARM9T/N2	03811625N0			
	50 / 5-5	16	15 VA cl. 0.5 Fs < 10	15 VA 5P10 - 7.5 VA 5P20	ARM6T/N2	03811626N0			
		16			ARM9T/N2	03811627N0			
		25			7.5 VA cl. 0.5 Fs < 10	7.5 VA 5P10	ARM6T/N2	03811628N0	
		25			15 VA cl. 0.5 Fs < 10	15 VA 5P10 - 7.5 VA 5P20	ARM9T/N2	03811629N0	
		31.5			7.5 VA cl. 0.5 Fs < 10	7.5 VA 5P10	ARM9T/N2	03811630N0	
		25			15 VA cl. 0.5 Fs < 10	15 VA 5P10 - 7.5 VA 5P20	ARM6T/N2	03811631N0	
	75 / 5-5	25	15 VA cl. 0.5 Fs < 10	15 VA 5P10 - 7.5 VA 5P20	ARM9T/N2	03811632N0			
		25			7.5 VA cl. 0.5 Fs < 10	7.5 VA 5P10	ARM6T/N2	03811633N0	
		31.5			15 VA cl. 0.5 Fs < 10	15 VA 5P10 - 7.5 VA 5P20	ARM9T/N2	03811634N0	
		31.5			7.5 VA cl. 0.5 Fs < 10	7.5 VA 5P10	ARM6T/N2	03811635N0	
		40			15 VA cl. 0.5 Fs < 10	15 VA 5P10 - 7.5 VA 5P20	ARM9T/N2	03811636N0	
		25			7.5 VA cl. 0.5 Fs < 10	7.5 VA 5P10	ARM6T/N2	03811637N0	
	100 / 5-5	25	15 VA cl. 0.5 Fs < 10	15 VA 5P10 - 7.5 VA 5P20	ARM9T/N2	03811638N0			
		25			7.5 VA cl. 0.5 Fs < 10	7.5 VA 5P10	ARM6T/N2	03811639N0	
		31.5			15 VA cl. 0.5 Fs < 10	15 VA 5P10 - 7.5 VA 5P20	ARM9T/N2	03811640N0	
		31.5			7.5 VA cl. 0.5 Fs < 10	7.5 VA 5P10	ARM6T/N2	03811641N0	
		40			15 VA cl. 0.5 Fs < 10	15 VA 5P10 - 7.5 VA 5P20	ARM9T/N2	03811642N0	
		25			7.5 VA cl. 0.5 Fs < 10	7.5 VA 5P10	ARM6T/N2	03811643N0	
	200 / 5-5	25	15 VA cl. 0.5 Fs < 10	15 VA 5P10 - 7.5 VA 5P20	ARM9T/N2	03811644N0			
		25			7.5 VA cl. 0.5 Fs < 10	7.5 VA 5P10	ARM6T/N2	03811645N0	
		31.5			15 VA cl. 0.5 Fs < 10	15 VA 5P10 - 7.5 VA 5P20	ARM9T/N2	03811646N0	
		31.5			7.5 VA cl. 0.5 Fs < 10	7.5 VA 5P10	ARM6T/N2	03811647N0	
		40			15 VA cl. 0.5 Fs < 10	15 VA 5P10 - 7.5 VA 5P20	ARM9T/N2	03811648N0	
		40			7.5 VA cl. 0.5 Fs < 10	7.5 VA 5P10	ARM6T/N2	03811649N0	
	400 / 5-5	40	15 VA cl. 0.5 Fs < 10	15 VA 5P10 - 7.5 VA 5P20	ARM9T/N2	03811650N0			
		40			7.5 VA cl. 0.5 Fs < 10	7.5 VA 5P10	ARM6T/N2	03811651N0	
600 / 5-5	40	20 VA cl. 0.5 Fs < 10	15 VA 5P10 - 7.5 VA 5P20	ARM9T/N2	03811652N0				
	40			7.5 VA cl. 0.5 Fs < 10	7.5 VA 5P10	ARM6T/N2	03811653N0		
750 / 5-5	40	20 VA cl. 0.5 Fs < 10	15 VA 5P10 - 7.5 VA 5P20	ARM9T/N2	03811654N0				
	40			7.5 VA cl. 0.5 Fs < 10	7.5 VA 5P10	ARM6T/N2	03811655N0		
1000 / 5-5	40	30 VA cl. 0.5 Fs < 10	10 VA 5P20	ARM9T/N2	03811656N0				
	40			7.5 VA cl. 0.5 Fs < 10	7.5 VA 5P10	ARM6T/N2	03811657N0		
ARM9T Dimensions page 28	1250 / 5-5	40		15 VA 5P20	ARM9T/N2	03811655N0			
	1500 / 5-5	40			ARM9T/N2	03811656N0			
	2000 / 5-5	40			ARM9T/N2	03811657N0			
	2500 / 5-5	40			ARM9T/N2	03811658N0			
	2500 / 5-5	40			ARM9T/N2	03811659N0			

DE58011

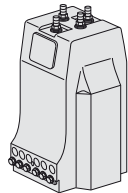

ARM6T

DE58012

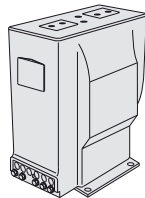

ARM9T

Dimensions page 28



Order form

17.5 - 24 - 36 kV split-over CT - single and double secondary

Single secondary metering CT

Insulation level and frequency	Transformation ratio A / A	Short-time thermal current kA x 1 s	Power, accuracy class, safety factor FS	Type	Reference	Qty
Ur 17.5 kV Ud 38 kV - 1 min Up 95 kV peak fr 50/60 Hz	2500 / 5	50	30 VA cl. 0.5 Fs < 10	ARO1b/N1	03811842N0	
	3000 / 5	50		ARO1b/N1	03811659N0	
Ur 24 kV Ud 50 kV - 1 min Up 125 kV peak fr 50/60 Hz	2500 / 5	50	30 VA cl. 0.5 Fs < 10	ARO2/N1	03811661N0	
	3000 / 5	50		ARO2/N1	03811663N0	
Ur 36 kV Ud 70 kV - 1 min Up 170 kV peak fr 50/60 Hz	2500 / 5	50	30 VA cl. 0.5 Fs < 10	ARO2/N1	03811665N0	
	3000 / 5	50		ARO2/N1	03811667N0	

Single secondary protection CT

Insulation level and frequency	Transformation ratio A / A	Short-time thermal current kA x 1 s	Power and accuracy class (possible double use)	Type	Reference	Qty
Ur 17.5 kV Ud 38 kV - 1 min Up 95 kV peak fr 50/60 Hz	2500 / 5	50	15 VA 5P20	ARO1b/N1	03811658N0	
	3000 / 5	50		ARO1b/N1	03811660N0	
Ur 24 kV Ud 50 kV - 1 min Up 125 kV peak fr 50/60 Hz	2500 / 5	50	15 VA 5P20	ARO2/N1	03811662N0	
	3000 / 5	50		ARO2/N1	03811664N0	
Ur 36 kV Ud 70 kV - 1 min Up 170 kV peak fr 50/60 Hz	2500 / 5	50	15 VA 5P20	ARO2/N1	03811666N0	
	3000 / 5	50		ARO2/N1	03811668N0	

Double secondary metering and protection CT

Insulation level and frequency	Transformation ratio A / A	Short-time thermal current kA x 1 s	Metering secondary: power, accuracy class, safety factor FS	Metering secondary: power and accuracy class (possible double use)	Type	Reference	Qty
Ur 17.5 kV Ud 38 kV - 1 min Up 95 kV peak fr 50/60 Hz	2500 / 5 - 5	50	30 VA cl. 0.5 Fs < 10	15 VA 5P20	ARO1b/N2	03811669N0	
	3000 / 5 - 5				ARO1b/N2	03811670N0	
Ur 24 kV Ud 50 kV - 1 min Up 125 kV peak fr 50/60 Hz	2500 / 5 - 5	50	30 VA cl. 0.5 Fs < 10	15 VA 5P20	ARO2/N2	03811671N0	
	3000 / 5 - 5				ARO2/N2	03811672N0	
Ur 36 kV Ud 70 kV - 1 min Up 170 kV peak fr 50/60 Hz	2500 / 5 - 5	50	30 VA cl. 0.5 Fs < 10	15 VA 5P20	ARO2/N2	03811673N0	
	3000 / 5 - 5				ARO2/N2	03811674N0	

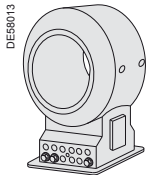

ARO1b
Dimensions page 28

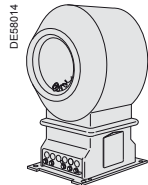

ARO2

Order form

0.72 kV closed core CT - single and double secondary

Single secondary metering CT

Insulation level and frequency	Transformation ratio A / A	Short-time thermal current kA x 1 s	Power, accuracy class, safety factor FS	Type	Reference	Qty
Ur 0.72 kV Ud 3 kV - 1 min fr 50/60 Hz	150 / 5	50	7.5 VA cl. 0.5 Fs < 10	ARC2/N1	03811675N0	
	200 / 5	50		ARC2/N1	03811676N0	
	250 / 5	50	15 VA cl. 0.5 Fs < 10	ARC2/N1	03811677N0	
	300 / 5	50		ARC2/N1	03811678N0	
	400 / 5	50		ARC2/N1	03811679N0	
	600 / 5	50	20 VA cl. 0.5 Fs < 10	ARC2/N1	03811680N0	
	750 / 5	50		ARC3/N1	03811681N0	
	1000 / 5	50	30 VA cl. 0.5 Fs < 10	ARC3/N1	03811682N0	
	1250 / 5	50		ARC3/N1	03811683N0	

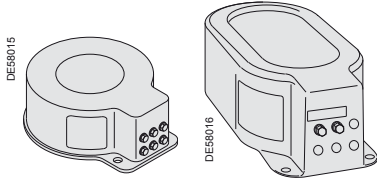

ARC2 ARC3
Dimensions page 28

Single secondary protection CT

Insulation level and frequency	Transformation ratio A / A	Short-time thermal current kA x 1 s	Power and accuracy class (possible double use)	Type	Reference	Qty
Ur 0.72 kV Ud 3 kV - 1 min fr 50/60 Hz	75 / 5	50	2.5 VA 5P20	ARC2/N1	03881124N0	
	100 / 5	50		ARC2/N1	03881125N0	
	150 / 5	50	5 VA 5P20	ARC2/N1	03881126N0	
	200 / 5	50		ARC2/N1	03881127N0	
	250 / 5	50		ARC2/N1	03881128N0	
	300 / 5	50		ARC2/N1	03881129N0	
	400 / 5	50	7.5 VA 5P20	ARC2/N1	03881130N0	
	600 / 5	50		ARC2/N1	03881131N0	
	750 / 5	50	10 VA 5P20	ARC3/N1	03881302N0	
	1000 / 5	50		ARC3/N1	03881303N0	
1250 / 5	50	ARC3/N1		03881304N0		

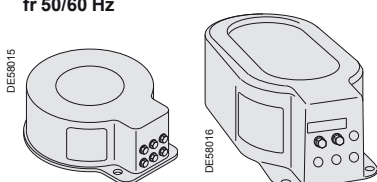

ARC2 ARC3
Dimensions page 28

Double secondary metering and protection CT

Insulation level and frequency	Transformation ratio A / A	Short-time thermal current kA x 1 s	Metering secondary: power, accuracy class, safety factor FS	Metering secondary: power and accuracy class (possible double use)	Type	Reference	Qty
Ur 0.72 kV Ud 3 kV - 1 min fr 50/60 Hz	250 / 5-5	50	10 VA cl. 0.5 Fs < 10	5 VA 5P20	ARC2/N2	03881141N0	
	300 / 5-5	50			ARC2/N2	03881142N0	
	400 / 5-5	50	15 VA cl. 0.5 Fs < 10	7.5 VA 5P20	ARC2/N2	03881143N0	
	600 / 5-5	50			ARC2/N2	03881144N0	
	750 / 5-5	50	20 VA cl. 0.5 Fs < 10	15 VA 5P20	ARC3/N2	03881305N0	
	1000 / 5-5	50			ARC3/N2	03881306N0	
	1250 / 5-5	50			ARC3/N2	03881307N0	

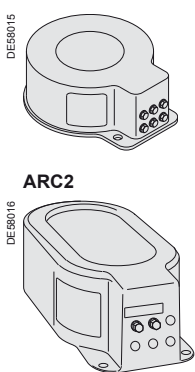

ARC2 ARC3
Dimensions page 28

AD12

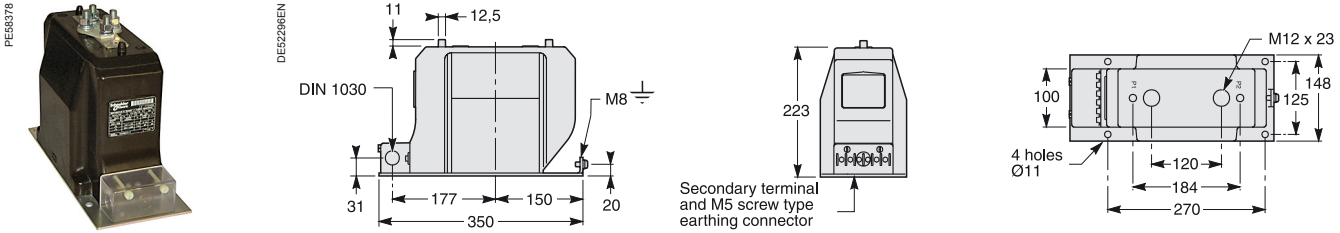

AD13

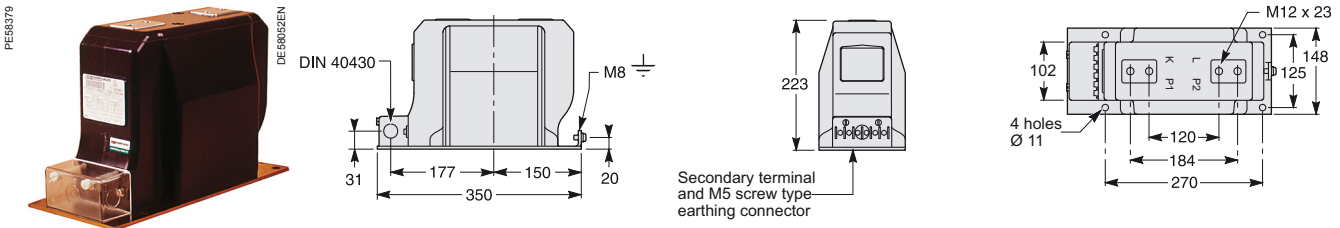

AD21

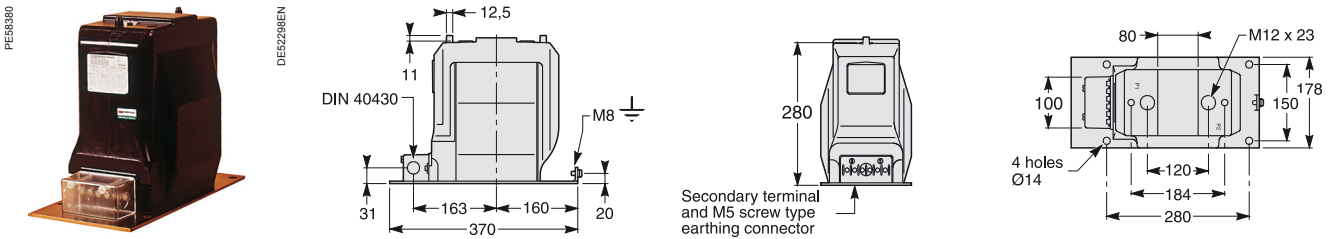

AD22

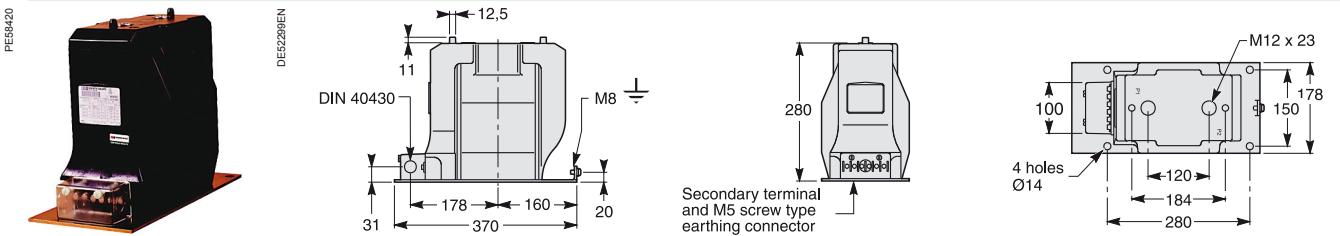

ARJD

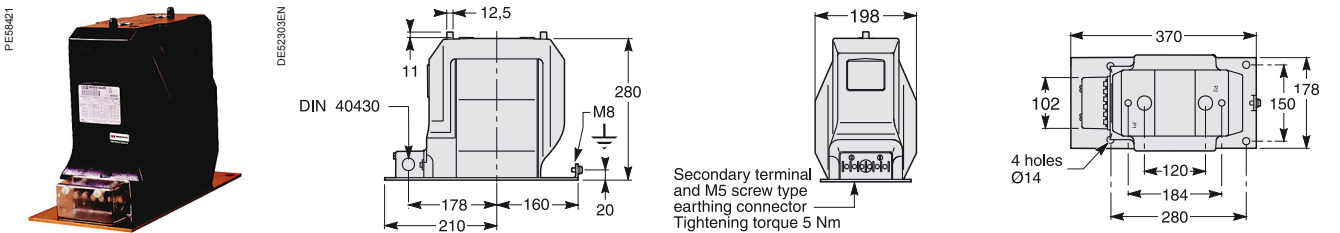

AD23

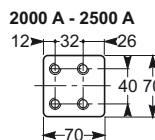
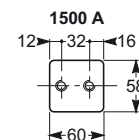
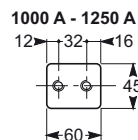
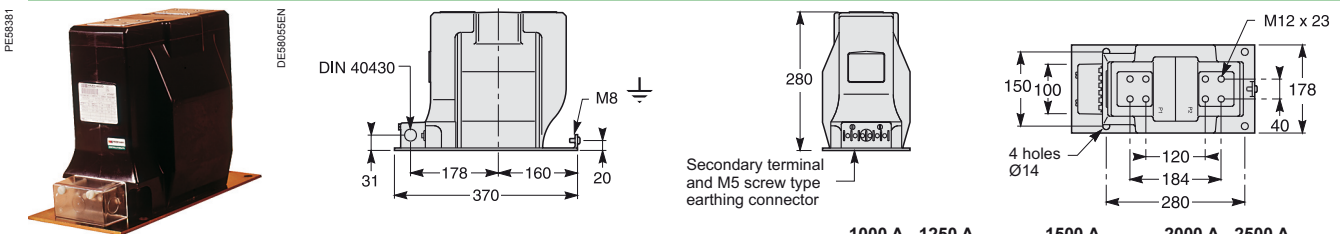

ARJP1

PE58387



DE52304EN

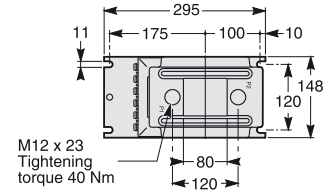
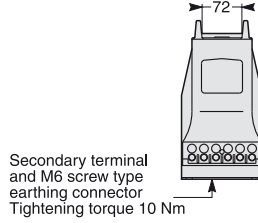
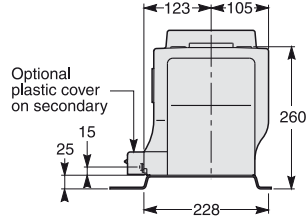

ARJP2

PE58388



DE52423EN

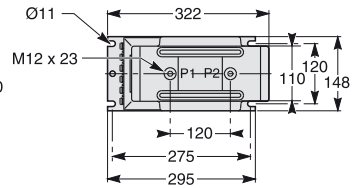
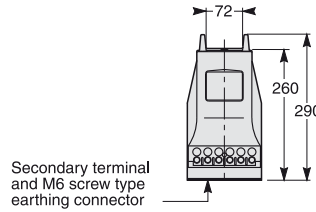
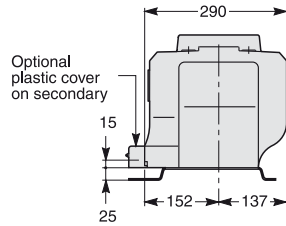

ARJM2

PE58386



DE52264EN

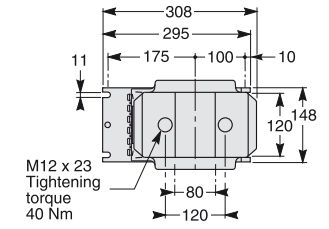
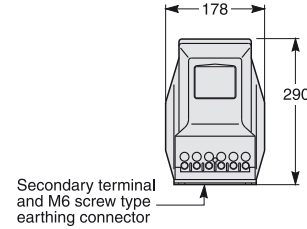
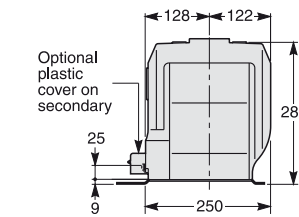

ARJH

PE83385



DE52305EN

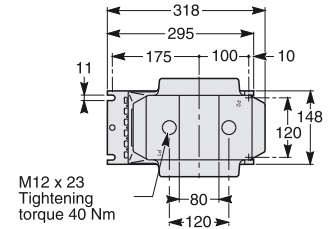
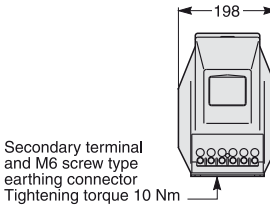
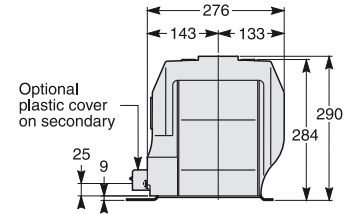

ARJP3

PE58389



DE58045EN

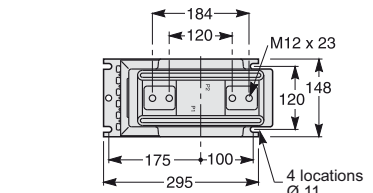
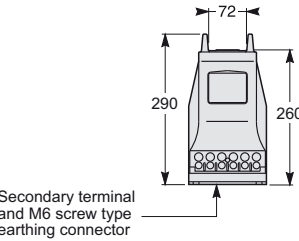
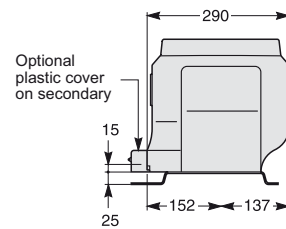

ARJA1

PE58384



DE58056EN

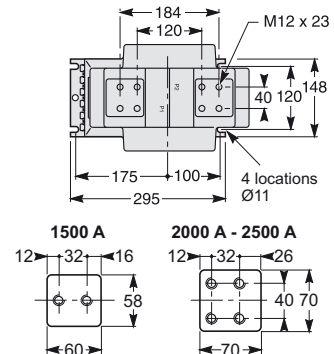
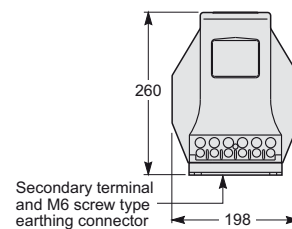
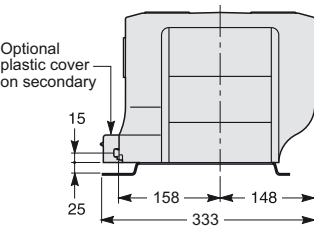

ARM6T

PE58390



DE52447EN

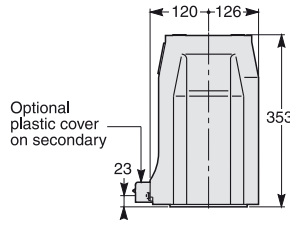

Optional plastic cover on secondary

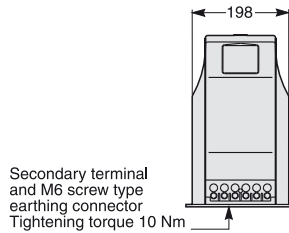

Secondary terminal and M6 screw type earthing connector
Tightening torque 10 Nm

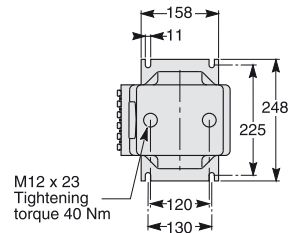

M12 x 23
Tightening torque 40 Nm

ARM9T

PE58391



DE58067EN

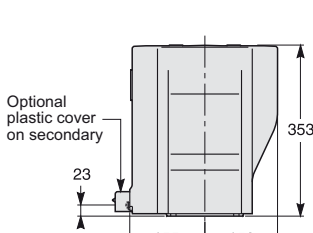

Optional plastic cover on secondary

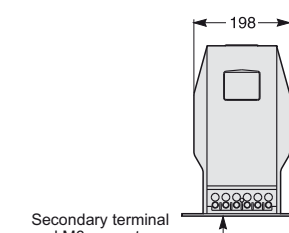

Secondary terminal and M6 screw type earthing connector
Tightening torque 10 Nm

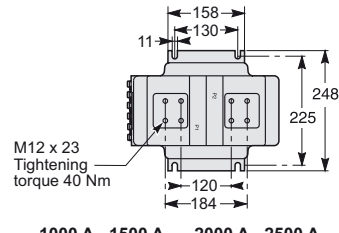

M12 x 23
Tightening torque 40 Nm

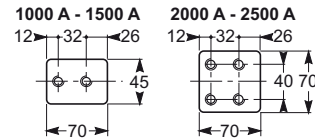

ARO1b

PE58382



DE58049EN

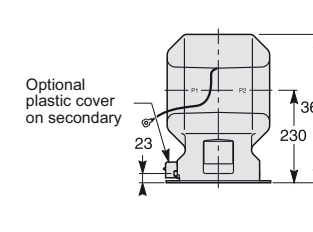

Optional plastic cover on secondary

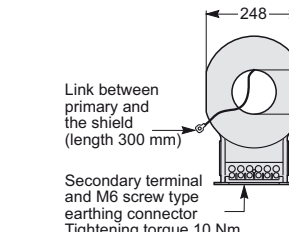

Link between primary and the shield (length 300 mm)
Secondary terminal and M6 screw type earthing connector
Tightening torque 10 Nm

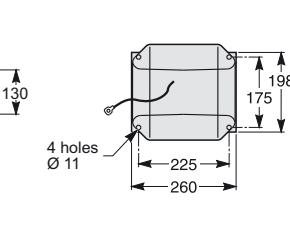

ARO2

PE58383



DE52302EN

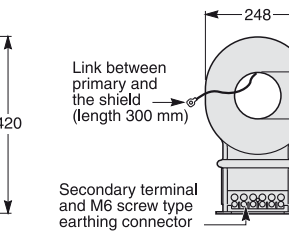
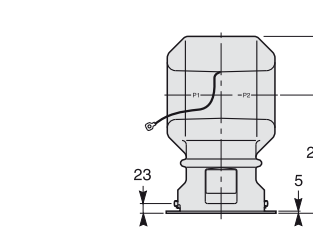

Link between primary and the shield (length 300 mm)
Secondary terminal and M6 screw type earthing connector

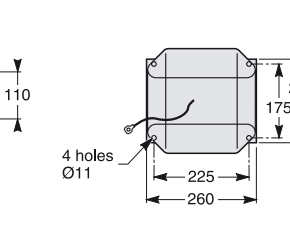

ARC2

PE58444



DE52308EN

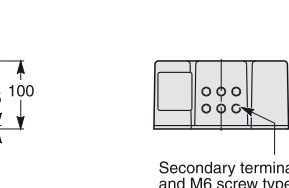
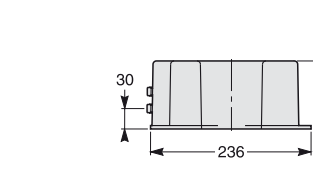

Secondary terminal and M6 screw type earthing connector
Tightening torque 10 Nm

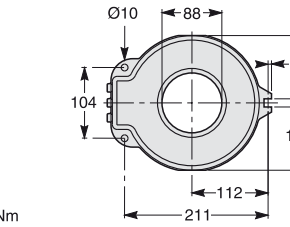

ARC3

PE58445



DE52308EN

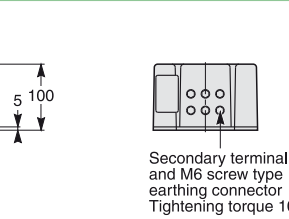
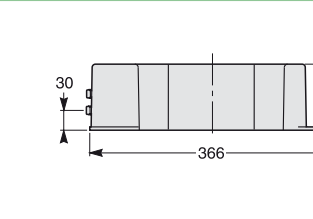

Secondary terminal and M6 screw type earthing connector
Tightening torque 10 Nm

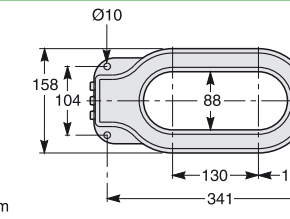

Selection guide	30
Technical description	30
Order form	31
Dimensions	32



LPCT's (Low Power Current Transformers) meet IEC standard IEC 60044-8. These are CT's with a direct voltage output which has the advantage of having a very wide range of applications, simplifying selection.

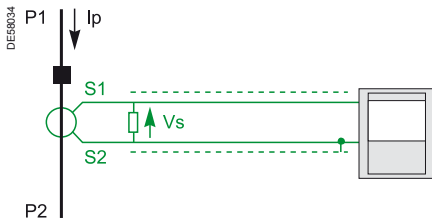

LPCT low power current transformers

LPCT's are specific current sensors with a direct voltage output of the "Low Power Current Transformers" type, in conformity with standard IEC 60044-8. LPCT's provide metering and protection functions.

They are defined by:

- the rated primary current
 - the extended primary current
 - the accuracy limit primary current or the accuracy limit factor.
- These have a linear response over a large current range and do not start to saturate until beyond the currents to be broken.

Examples of LPCT characteristics according to IEC standard 60044-8

These characteristics are summarized in the curves below. They show the maximum error limits (as an absolute value) on the current and the phase corresponding to the accuracy class for the given examples.

They give the same error limits shown for these classes in page 9, but with much wider current ranges, which gives an advantage to this type of sensor.

Example for metering class 0.5

- rated primary current $I_{pn} = 100\text{ A}$
 - extended primary current $I_{pe} = 1250\text{ A}$
 - secondary voltage $V_{sn} = 22.5\text{ mV}$ (for 100 A on the secondary)
 - class 0.5:
 - accuracy (see definitions page 13) on:
 - the primary current module 0.5% (error $\leq \pm 0.5\%$)
 - the primary current phase 60 min (error $\leq 30\text{ minutes}$)
- over a range of 100 A to 1250 A
- accuracy 0.75% and 45 min at 20 A
 - accuracy 1.5% and 90 min at 5 A.
- which are two metering points specified by the standard.

Example for class 5P protection

- primary current $I_{pn} = 100\text{ A}$
- secondary voltage $V_{sn} = 22.5\text{ mV}$
- class 5P:
- accuracy (see definitions page 9) on:
 - the primary current module 5% (error $\leq \pm 5\%$)
 - the primary current phase 60 min (error $\leq 60\text{ minutes}$) on a range of 1.25 kA to 40 kA.

The LPCT and Sepam guarantees a very high coverage range and flexibility of usage. Example: protection system with CLP1 or CLP2 and Sepam guaranteeing a usage range of 5 A to 1250 A.

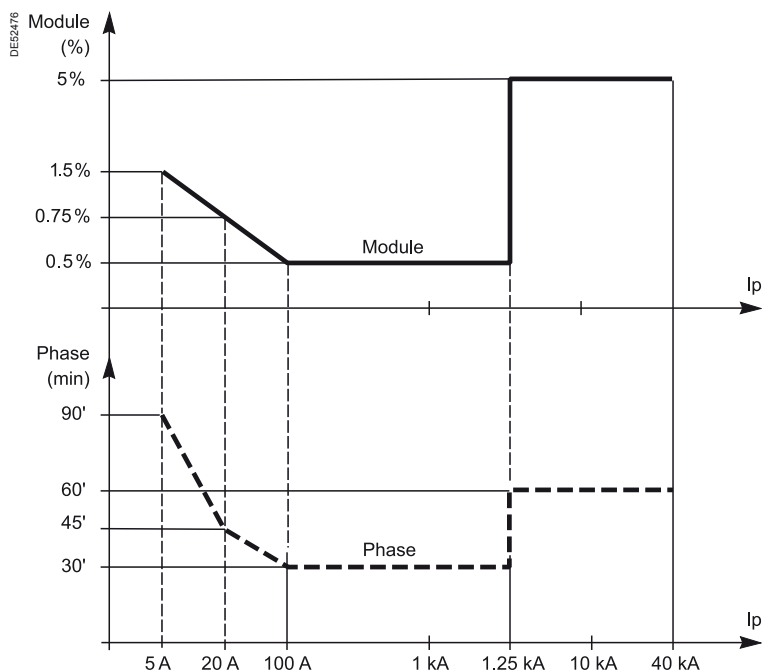

Accuracy characteristics of a LPCT (example of Schneider Electric's CLP1): the accuracy classes are given for extended current ranges (here class 0.5 for metering from 100 to 1250 A and protection class 5P from 1.25 to 40 kA).

Primary current rated (A)	Primary current extended (A)	Secondary voltage (mV)	Accuracy class	Accuracy limit factor FLP	Short-time thermal current	Rated insulation (kV)	Secondary connector	Internal diameter (mm)	Type	Reference	Qty
100	1250	22.5	0.5 – 5P	500	50 kA - 1 s 40 kA - 3 s	17.5	RJ45 - 8 pts		CLP1	62623	
100	1250	22.5	0.5 – 5P	400	40 kA - 3 s	24	RJ45 - 8 pts		CLP2	51238696F0	
100	2500	22.5	0.5 – 5P	400	40 kA - 3 s	24	RJ45 - 8 pts		CLP3	AAA10474	
100	2500	22.5	0.5 – 5P	400	40 kA - 3 s	0.72	RJ45 - 8 pts	160	TLP160	AAA10094	
100	2500	22.5	0.5 – 5P	400	40 kA - 3 s	0.72	RJ45 - 8 pts	190	TLP190	AAA10095	

Frequency and insulation

Frequency (Hz)	Ur (kV)	Ud (kV - 1 min)	Up (kV peak)
50 / 60	24	50	125
	17.5	38	95
	0.72	3	



CLP1

PE58394

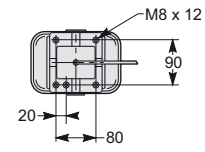
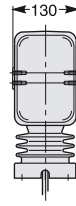
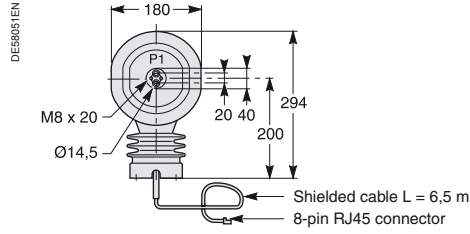

CLP2

PE58395

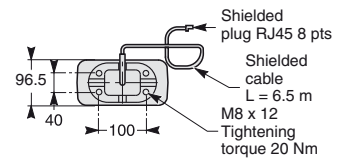
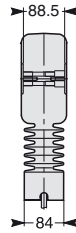
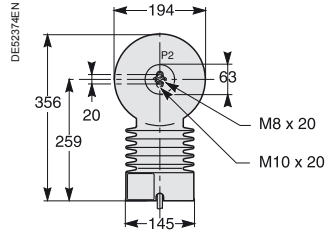

CLP3

PE58396

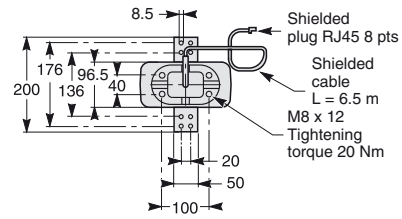
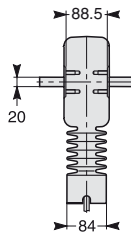
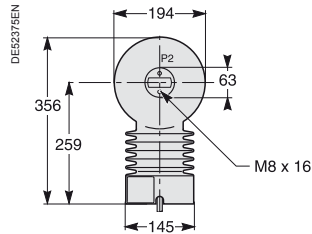

TLP160

PE56703

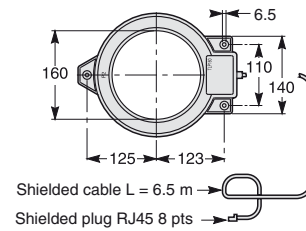
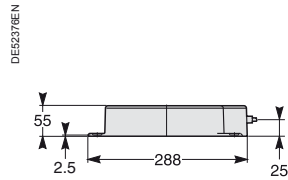

TLP190

PE56397

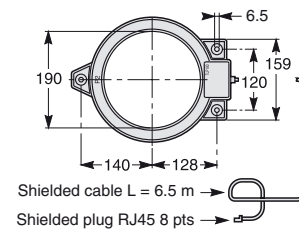
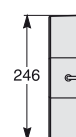
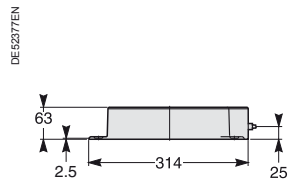

Selection guide	34
Technical description	34
Order form	39
DIN standard phase-earth VT	39
DIN standard phase-phase VT	40
Phase-earth VT	41
Phase-earth VT with fuse-holder	43
Installation structure for phase-earth VT with fuse-holder	44
Phase-phase VT	45
Dimensions	46
DIN standard VT	46
Phase-earth VT	47
Phase-earth VT with fuse-holder	48
Phase-phase VT	48



Voltage transformers (VT) meet standards IEC 60044-2.

Their function is to supply a voltage proportional to the MV circuit that they are installed on to the secondary.

The primary, which is parallel mounted on the MV network between phases or from phase to earth, is subject to the same over-voltages as the latter. The secondary supplies a voltage that is virtually constant, whatever the load.

The secondary must never be placed in short circuit.

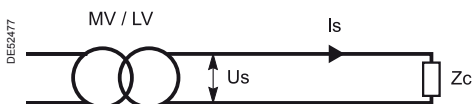

Simplified schematic diagram of a voltage transformer
Is: secondary current
Us: secondary voltage
Zc: load impedance.

Voltage transformers (VT)

Voltage transformers have two key functions:

- adapting the value of MV voltage on the primary to the characteristics of metering or protection devices by supplying a secondary voltage that is proportional and lower
- isolating power circuits from the metering and/or protection circuit.

Composition and type

These comprise a primary winding, a magnetic core, one or several secondary windings, with everything encapsulated in an insulating resin.

There are two types, according to how they are connected:

- phase/phase: primary connected between two phases
- phase/earth: primary connected between a phase and the earth.

Characteristics

These are defined by standard IEC 60044-2.

Insulation

Characterized by the rated voltages:

- insulation voltage, which will be that of the installation (e.g.: 24 kV)
- power frequency withstand 1 min (e.g.: 50 kV)
- impulse withstand (e.g.: 125 kV).

Rated frequency

50 or 60 Hz.

Rated primary voltage (U_{pn})

According to their design, voltage transformers are connected:

- either between phase and earth and in this case $U_{pn} = U/\sqrt{3}$ (e.g.: $20/\sqrt{3}$)
- or between phases and in this case $U_{pn} = U$.

Rated secondary voltage (U_{sn})

This is equal to 100 or 110 V for phase/phase voltage transformers. For single phase, phase/earth transformers, the secondary voltage must be divided by $\sqrt{3}$ (e.g.: $100/\sqrt{3}$).

Accuracy power P_n

Apparent power (VA) that the VT can supply the secondary for the rated secondary voltage for which the accuracy is guaranteed (accuracy load).

Standardized values 30, 50, 100 VA (IEC).

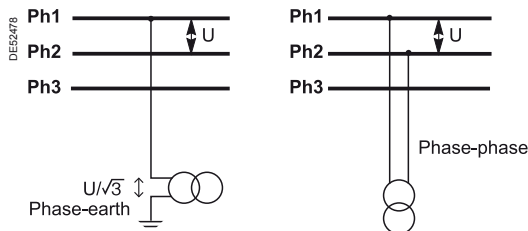

Connection of a VT

Accuracy class

Defines the error limits guaranteed relative to the transformation ratio and the phase shift under specified conditions of power and voltage.

Voltage error ε (%)

Error that the transformer introduces into the voltage measurement when the transformation ratio is different from the rated value.

Phase shift or phase error (ψ in minutes)

Phase difference between primary and secondary voltages, in angle minutes.

Rated voltage factor KT

This is the factor, a multiple of the rated primary voltage, which determines the maximum voltage which the transformer must meet the specified temperature rise and accuracy recommendations. The maximum operating voltage depends on the network neutral system and the earthing conditions of the primary winding.

Table of voltage factors KT

Voltage factor	Rated duration	Connection mode of the primary winding	Network neutral system
1.2	Continuous	Between phases	Any
	Continuous	Between the star-connected transformer neutral point and earth	Any
1.2	Continuous	Between phase and earth	Directly earthed
1.5	30 s		
1.2	Continuous	Between phase and earth	Earthed via a limiting resistor with automatic earthing fault elimination
1.9	30 s		
1.2	Continuous	Between phase and earth	Insulated neutral without automatic earthing fault elimination
1.9	8 h		
1.2	Continuous	Between phase and earth	Earthed via a limiting resistance with automatic earthing fault elimination

Table of voltage transformer characteristics

Characteristics	Rated values				
Insulating voltage (kV)	7.2	12	17.5	24	36
■ power frequency withstand (kV) ⁽¹⁾ 1 min	20	28	38	50	70
■ lightning impulse withstand (kV - peak)	60	75	95	125	170
Frequency (Hz)	50 - 60				
Primary voltage U1n (kV) (divided by $\sqrt{3}$ if single phase)	3 - 3.3 - 5 - 5.5 - 6 - 6.6 - 10 - 11 - 13.8 - 15 - 20 - 22 - 30 - 33				
Secondary voltage U2n (V)	100 - 110 or $100/\sqrt{3}$ - $110/\sqrt{3}$				
Accuracy power (VA)	30 - 50 - 100				

(1) When there is a major difference between the highest voltage for the equipment (U_m) and the rated primary voltage, the power frequency must be limited to five times the rated voltage.

VT operating characteristics

Operation of a VT is more simple than that of a CT because the secondary voltage is virtually independent of the load, due to it being connected through a high impedance (virtually used in an open circuit).

Therefore, **the secondary must not be short circuited**. Under these conditions an excessively high current will damage the transformer.

VT connections

Several metering connection arrangements are possible (fig. opposite)

- star-connection of 3 transformers: requires 1 isolated MV terminal for each transformer
- connecting to 2 transformers, so-called V-connection: requires 2 isolated MV terminals per transformer.

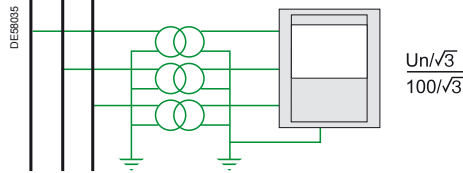

Star-connected VT and example of transformation ratio

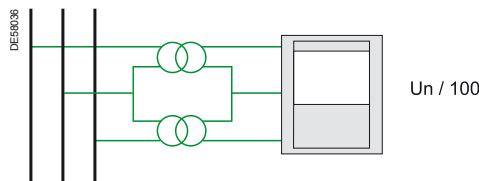

V-connected VT and example of the transformation ratio

Residual voltage metering

The residual voltage which characterizes the voltage of the neutral point relative to earth, is equal to the vectorial sum of the three phase-earth voltages. The residual voltage is equal to 3 times the zero-sequence voltage V_0 .

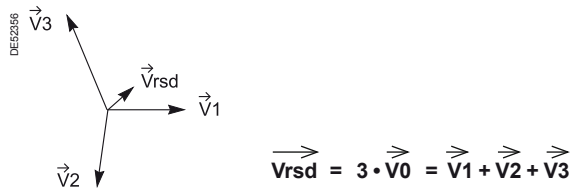

Please note, it is impossible to measure a residual voltage with **phase/phase VT's**.

The appearance of this voltage signifies the existence of an earthing fault.

It is obtained by measurement or by calculation:

- measuring by three voltage transformers whose primary circuits are star-connected and whose secondary circuits are open-delta connected, supplying the residual voltage ①
- calculation by the relay based on three voltage transformers whose primary and secondary circuits are star-connected ②.

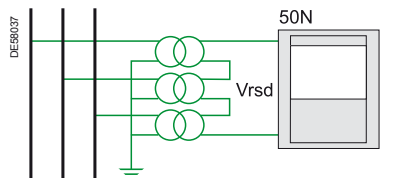

① Direct measurement of the residual voltage

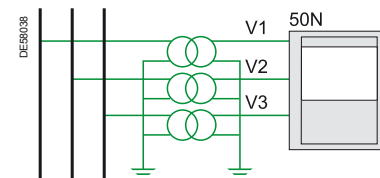

② Calculation of the residual voltage

Voltage transformer for metering

Accuracy class

These devices are intended to send an image as accurately as possible of the rated primary voltage between **80 and 120%** of the latter.

The accuracy class determines the permissible error in the phase and in the module in this range for the accuracy load.

It is valid for all loads of between 25 and 100% of the rated accuracy power with an inductive power factor of 0.8.

The table below gives the usual classes according to application.

Application	Class
Accurate laboratory metering applications (calibration devices)	0.2
Billing metering industrial measurements	0.2
Statistical switchboard metering indicators	0.5 - 1

■ **Class 0.5** corresponds to an error $\leq \pm 0.5\%$ for the rated primary voltage, with the accuracy load over the secondary.

■ **Class 1** corresponds to an error $\leq \pm 1\%$ in the same conditions.

For a given accuracy class, voltage and phase-shift errors must not exceed the values indicated in the table opposite.

Error limits according to the accuracy class

Accuracy class	Voltage error (ratio) $\pm \%$	Phase-shift error \pm min
0.2	0.2	10
0.5	0.5	20
1	1.0	40

Example:

Metering voltage transformer $\frac{20000}{\sqrt{3}} / \frac{110}{\sqrt{3}}$, 50 VA, cl. 0.5

■ rated primary voltage $20000 \text{ V}/\sqrt{3}$, rated secondary $110 \text{ V}/\sqrt{3}$

■ accuracy power 50 VA

■ accuracy class 0.5. The table of limit error values gives, under the specified conditions for the accuracy class:

□ a primary voltage 80% to 120% of the rated voltage (16 kV to 24 kV)

□ a load of between 25% and 100% of the accuracy power, i.e. between 12.5 VA and 50 VA with an inductive power factor of 0.8, the metering errors will be $\leq \pm 0.5\%$ for voltage and $\leq \pm 20$ min for phase shift.

Voltage transformer for protection

Accuracy class

These devices are intended to send an image that is as accurate as possible of the voltage in the case of a fault (voltage drop or overvoltage).

They must have the right accuracy and power for the fault voltages and therefore different from those used for instrument transformers.

In practice, the accuracy class **3P** is used for all applications and the error limits for voltage and phase given in the table below.

These are guaranteed for all loads of between 25 and 100% of the accuracy power with an inductive power factor of 0.8.

Error limits for each accuracy class

Accuracy class	Voltage error ($\pm \%$) between		Phase-shift error (minutes) between	
	5% Upn and KT	2% Upn and KT	5% Upn and KT	2% Upn and KT
3P	3	6	120	240
6P	6	12	240	480

KT: over-voltage coefficient.

Upn: rated primary voltage.

Example:

Protection voltage transformer $\frac{20000}{\sqrt{3}} / \frac{110}{3}$, 100 VA, 3P, KT = 1.9 8h

■ rated primary voltage $20000 \text{ V}/\sqrt{3}$, rated secondary $110 \text{ V}/3$

■ accuracy power 100 VA

■ accuracy class 3P. The table of limit values shows that for:

□ a primary voltage of 5% of the rated voltage at KT times the rated voltage, i.e. $20000 \times 5\% = 1000 \text{ V}$ at $20000 \times 1.9 = 38000 \text{ V}$

□ a load of between 25% and 100% of the accuracy power, in other words of between 25 VA and 100 VA with a power factor of 0.8, the metering error will be $\leq \pm 3\%$ in voltage and $\leq \pm 120$ min in phase shift.

Connecting a VT

VT with a double (or triple) secondary

A VT can have one or two secondaries (figure opposite), and more rarely three secondaries for the appropriate applications (protection and/or metering).

Identifying terminals

A VT is connected across the terminals identified according to the IEC:

- A for phase and N for earth on the MV side
- a and n on the corresponding secondary side. In the case of a double output, the first output is shown by 1a and 1n, the second by 2a and 2n.

Single (grounded) pole

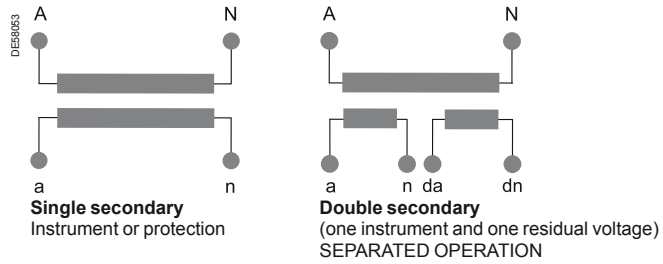

Two (insulated) poles

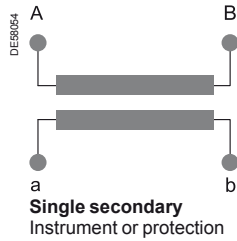

Calculating the power (VA)

Indicative metering consumption

Device		Max. consumption in VA (per circuit)
Voltmeter	Electromagnetic	5
	Electronic	1
Transducer	Self-powered	5
	External power	2
Meter	Induction	5
	Electronic	4
	Wattmeter, varmeter	5

Indicative protection consumption

Device	Consumption in VA (per circuit)
Static overvoltage relay	0.2 to 1
Electromagnetic overvoltage relay	1 to 8

Single secondary metering VT

Frequency: 50 - 60 Hz

Rated voltage kV	Power frequency withstand kV-1 min	Lightning impulse withstand kV-peak	Transformation ratio V / V	Power and accuracy class (double use)	Type	Reference	Qty
7.2	9	60	$3000:\sqrt{3} / 100:\sqrt{3}$	30 VA - 50 VA cl. 0.5	VDF12n/S1	03811684N0	
	10		$3300:\sqrt{3} / 110:\sqrt{3}$		VDF12n/S1	03811685N0	
	15		$5000:\sqrt{3} / 100:\sqrt{3}$		VDF12n/S1	03811686N0	
	16		$5500:\sqrt{3} / 110:\sqrt{3}$		VDF12n/S1	03811687N0	
	20		$6000:\sqrt{3} / 100:\sqrt{3}$		VDF12n/S1	03811688N0	
12	20	75	$6000:\sqrt{3} / 100:\sqrt{3}$	30 VA - 50 VA cl. 0.5	VDF12n/S1	03811689N0	
			$6600:\sqrt{3} / 110:\sqrt{3}$		VDF12n/S1	03811691N0	
	28		$10000:\sqrt{3} / 100:\sqrt{3}$		VDF12n/S1	03811692N0	
			$11000:\sqrt{3} / 110:\sqrt{3}$		VDF12n/S1	03811693N0	
17.5	38	95	$13800:\sqrt{3} / 110:\sqrt{3}$	30 VA - 50 VA cl. 0.5	VDF21n/S1	03811694N0	
	$15000:\sqrt{3} / 100:\sqrt{3}$	VDF21n/S1	03811695N0				
24	44	125	$15000:\sqrt{3} / 100:\sqrt{3}$	30 VA - 50 VA cl. 0.5	VDF21n/S1	03811696N0	
	50		$20000:\sqrt{3} / 100:\sqrt{3}$		VDF21n/S1	03811697N0	
			$22000:\sqrt{3} / 110:\sqrt{3}$		VDF21n/S1	03811698N0	

Double secondary metering and protection VT

Frequency: 50 - 60 Hz

Rated voltage kV	Power frequency withstand kV-1 min	Lightning impulse withstand kV-peak	Transformation ratio V / V	Power, accuracy class for metering secondary (double use)	Power, accuracy class for protection secondary	Type	Reference	Qty
7.2	9	60	$3000:\sqrt{3} / 100:\sqrt{3}-100:3$	30 VA - 50 VA cl. 0.5	50 VA 3P	VDF12n/S2	03811699N0	
	10		$3300:\sqrt{3} / 110:\sqrt{3}-110:3$			VDF12n/S2	03811700N0	
	15		$5000:\sqrt{3} / 100:\sqrt{3}-100:3$			VDF12n/S2	03811701N0	
	16		$5500:\sqrt{3} / 110:\sqrt{3}-110:3$			VDF12n/S2	03811702N0	
	20		$6000:\sqrt{3} / 100:\sqrt{3}-100:3$			VDF12n/S2	03811703N0	
12	20	75	$6000:\sqrt{3} / 100:\sqrt{3}-100:3$	30 VA - 50 VA cl. 0.5	50 VA 3P	VDF12n/S2	03811704N0	
			$6600:\sqrt{3} / 110:\sqrt{3}-110:3$			VDF12n/S2	03811705N0	
	28		$10000:\sqrt{3} / 100:\sqrt{3}-100:3$			VDF12n/S2	03811706N0	
			$11000:\sqrt{3} / 110:\sqrt{3}-110:3$			VDF12n/S2	03811708N0	
17.5	38	95	$13800:\sqrt{3} / 110:\sqrt{3}-110:3$	30 VA - 50 VA cl. 0.5	50 VA 3P	VDF21n/S2	03811709N0	
			$15000:\sqrt{3} / 100:\sqrt{3}-100:3$			VDF21n/S2	03811710N0	
24	44	125	$15000:\sqrt{3} / 100:\sqrt{3}-100:3$	30 VA - 50 VA cl. 0.5	50 VA 3P	VDF21n/S2	03811711N0	
	50		$20000:\sqrt{3} / 100:\sqrt{3}-100:3$			VDF21n/S2	03811712N0	
			$22000:\sqrt{3} / 110:\sqrt{3}-110:3$			VDF21n/S2	03811713N0	

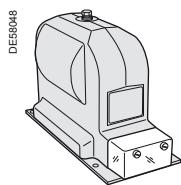

VDF12
Dimensions page 46

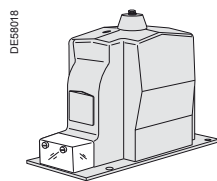

VDF21

Single secondary metering VT

Frequency: 50 - 60 Hz

Rated voltage kV	Power frequency withstand kV-1 min	Lightning impulse withstand kV-peak	Transformation ratio V / V	Power and accuracy class (double use)	Type	Reference	Qty
7.2	15	60	3000 / 100	50 VA cl. 0.5	VDC11/S1	03811777N0	
			3300 / 110		VDC11/S1	03811778N0	
	5000 / 100		VDC11/S1		03811779N0		
	5500 / 110		VDC11/S1		03811780N0		
	6000 / 100		VDC11/S1		03811781N0		
	6600 / 110		VDC11/S1		03811782N0		
12	28	75	6000 / 100	50 VA cl. 0.5	VDC11/S1	03811783N0	
			6600 / 110		VDC11/S1	03811784N0	
			10000 / 100		VDC11/S1	03811785N0	
			11000 / 110		VDC11/S1	03811786N0	
17.5	38	95	10000 / 100	50 VA cl. 0.5	VDC21/S1	03811787N0	
			11000 / 110		100 VA cl. 0.5	VDC21/S1	03811788N0
			13800 / 100	50 VA cl. 0.5	VDC21/S1	03811789N0	
				100 VA cl. 0.5	VDC21/S1	03811790N0	
			15000 / 100	50 VA cl. 0.5	VDC21/S1	03811791N0	
				100 VA cl. 0.5	VDC21/S1	03811792N0	
24	50	125	15000 / 100	50 VA cl. 0.5	VDC21/S1	03811793N0	
				100 VA cl. 0.5	VDC21/S1	03811794N0	
			20000 / 100	50 VA cl. 0.5	VDC21/S1	03811795N0	
				100 VA cl. 0.5	VDC21/S1	03811796N0	
			22000 / 110	50 VA cl. 0.5	VDC21/S1	03811797N0	
				100 VA cl. 0.5	VDC21/S1	03811798N0	
			22000 / 110	50 VA cl. 0.5	VDC21/S1	03811799N0	
				100 VA cl. 0.5	VDC21/S1	03811800N0	

DE50019

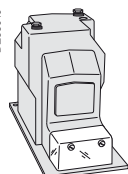

VDC11
Dimensions page 46

Single secondary metering VT

Frequency: 50 - 60 Hz

Rated voltage kV	Power frequency withstand kV-1 min	Lightning impulse withstand kV-peak	Transformation ratio V / V	Power and accuracy class (double use)	Type	Reference	Qty
7.2	9	60	3000: $\sqrt{3}$ / 100: $\sqrt{3}$	30 VA - 50 VA cl. 0.5	VRFRn/S1	03811714N0	
				100 VA cl. 0.5	VRQ1n/S1	03811715N0	
	10	60	3300: $\sqrt{3}$ / 110: $\sqrt{3}$	30 VA - 50 VA cl. 0.5	VRFRn/S1	03811716N0	
				100 VA cl. 0.5	VRQ1n/S1	03811717N0	
	15	60	5000: $\sqrt{3}$ / 100: $\sqrt{3}$	30 VA - 50 VA cl. 0.5	VRFRn/S1	03811718N0	
				100 VA cl. 0.5	VRQ1n/S1	03811719N0	
	16	60	5500: $\sqrt{3}$ / 110: $\sqrt{3}$	30 VA - 50 VA cl. 0.5	VRFRn/S1	03811720N0	
				100 VA cl. 0.5	VRQ1n/S1	03811721N0	
	20	60	6000: $\sqrt{3}$ / 100: $\sqrt{3}$	30 VA - 50 VA cl. 0.5	VRFRn/S1	03811722N0	
				100 VA cl. 0.5	VRQ1n/S1	03811723N0	
6600: $\sqrt{3}$ / 110: $\sqrt{3}$				30 VA - 50 VA cl. 0.5	VRFRn/S1	03811724N0	
100 VA cl. 0.5				VRQ1n/S1	03811725N0		
12	20	75	6000: $\sqrt{3}$ / 100: $\sqrt{3}$	30 VA - 50 VA cl. 0.5	VRFRn/S1	03811726N0	
			100 VA cl. 0.5	VRQ1n/S1	03811727N0		
			6600: $\sqrt{3}$ / 110: $\sqrt{3}$	30 VA - 50 VA cl. 0.5	VRFRn/S1	03811728N0	
			100 VA cl. 0.5	VRQ1n/S1	03811729N0		
	28	75	10000: $\sqrt{3}$ / 100: $\sqrt{3}$	30 VA - 50 VA cl. 0.5	VRFRn/S1	03811730N0	
				100 VA cl. 0.5	VRQ1n/S1	03811731N0	
			11000: $\sqrt{3}$ / 110: $\sqrt{3}$	30 VA - 50 VA cl. 0.5	VRFRn/S1	03811732N0	
			100 VA cl. 0.5	VRQ1n/S1	03811733N0		
17.5	28	95	10000: $\sqrt{3}$ / 100: $\sqrt{3}$	30 VA - 50 VA cl. 0.5	VRFRn/S1	03811734N0	
			100 VA cl. 0.5	VRQ1n/S1	03811735N0		
			11000: $\sqrt{3}$ / 110: $\sqrt{3}$	30 VA - 50 VA cl. 0.5	VRQ3n/S1	03811736N0	
			100 VA cl. 0.5	VRQ1n/S1	03811737N0		
	38	95	13800: $\sqrt{3}$ / 110: $\sqrt{3}$	30 VA - 50 VA cl. 0.5	VRQ3n/S1	03811738N0	
				100 VA cl. 0.5	VRQ1n/S1	03811739N0	
			15000: $\sqrt{3}$ / 100: $\sqrt{3}$	30 VA - 50 VA cl. 0.5	VRQ3n/S1	03811740N0	
			100 VA cl. 0.5	VRQ1n/S1	03811741N0		
24	44	125	15000: $\sqrt{3}$ / 100: $\sqrt{3}$	30 VA - 50 VA cl. 0.5	VRQ2n/S1	03811742N0	
			100 VA cl. 0.5	VRQ1n/S1	03811743N0		
	50	125	20000: $\sqrt{3}$ / 100: $\sqrt{3}$	30 VA - 50 VA cl. 0.5	VRQ2n/S1	03811744N0	
				100 VA cl. 0.5	VRQ1n/S1	03811745N0	
			22000: $\sqrt{3}$ / 110: $\sqrt{3}$	30 VA - 50 VA cl. 0.5	VRQ2n/S1	03811746N0	
			100 VA cl. 0.5	VRQ1n/S1	03811747N0		
36	70	170	30000: $\sqrt{3}$ / 100: $\sqrt{3}$	100 VA cl. 0.5	VRF3n/S1	03811748N0	
			33000: $\sqrt{3}$ / 110: $\sqrt{3}$	100 VA cl. 0.5	VRF3n/S1	03811749N0	

DIES8020

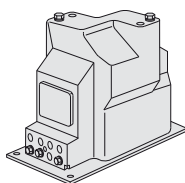

VRFR
Dimensions page 47

DIES8021

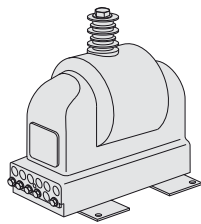

VRF3

DIES8022

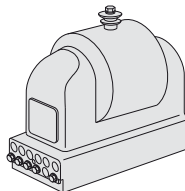

VRQ1

DIES8022

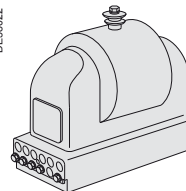

VRQ2

DIES8023

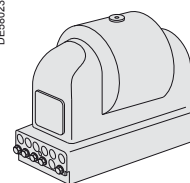

VRQ3

Double secondary metering and protection VT

Frequency: 50 - 60 Hz

Rated voltage kV	Power frequency withstand kV-1 min	Lightning impulse withstand kV-peak	Transformation ratio V / V	Power, accuracy class for metering secondary (double use)	Power, accuracy class for protection secondary	Type	Reference	Qty
7.2	9	60	3000:√3 / 100:√3 -100:3	30 VA cl. 0.5	50 VA 3P	VRQ3n/S2	AAD62558	
				50 VA cl. 0.5		VRQ3n/S2	AAD62559	
				100 VA cl. 0.5		VRQ1n/S2	03811750N0	
	10	60	3300:√3 / 110:√3 -110:3	30 VA cl. 0.5	50 VA 3P	VRQ3n/S2	AAD62567	
				50 VA cl. 0.5		VRQ3n/S2	AAD62568	
				100 VA cl. 0.5		VRQ1n/S2	03811751N0	
	15	60	5000:√3 / 100:√3 -100:3	30 VA cl. 0.5	50 VA 3P	VRQ3n/S2	AAD62561	
				50 VA cl. 0.5		VRQ3n/S2	AAD62562	
				100 VA cl. 0.5		VRQ1n/S2	03811752N0	
	16	60	5500:√3 / 110:√3 -110:3	30 VA cl. 0.5	50 VA 3P	VRQ3n/S2	AAD62570	
				50 VA cl. 0.5		VRQ3n/S2	AAD62571	
				100 VA cl. 0.5		VRQ1n/S2	03811753N0	
	20	60	6000:√3 / 100:√3 -100:3	30 VA cl. 0.5	50 VA 3P	VRQ3n/S2	AAD62564	
				50 VA cl. 0.5		VRQ3n/S2	AAD62565	
				100 VA cl. 0.5		VRQ1n/S2	03811754N0	
6600:√3 / 110:√3 -110:3			30 VA cl. 0.5	50 VA 3P	VRQ3n/S2	AAD62574		
			50 VA cl. 0.5		VRQ3n/S2	AAD62575		
			100 VA cl. 0.5		VRQ1n/S2	03811755N0		
12	20	75	6000:√3 / 100:√3 -100:3	30 VA cl. 0.5	50 VA 3P	VRQ3n/S2	AAD62576	
				50 VA cl. 0.5		VRQ3n/S2	AAD62577	
				100 VA cl. 0.5		VRQ1n/S2	03811756N0	
		6600:√3 / 110:√3 -110:3	30 VA cl. 0.5	50 VA 3P	VRQ3n/S2	AAD62582		
			50 VA cl. 0.5		VRQ3n/S2	AAD62583		
			100 VA cl. 0.5		VRQ1n/S2	03811757N0		
	28	75	10000:√3 / 100:√3 -100:3	30 VA cl. 0.5	50 VA 3P	VRQ3n/S2	AAD62579	
				50 VA cl. 0.5		VRQ3n/S2	AAD62580	
				100 VA cl. 0.5		VRQ1n/S2	03811758N0	
			11000:√3 / 110:√3 -110:3	30 VA cl. 0.5	50 VA 3P	VRQ3n/S2	AAD62585	
				50 VA cl. 0.5		VRQ3n/S2	AAD62586	
				100 VA cl. 0.5		VRQ1n/S2	03811759N0	
17.5	28	95	10000:√3 / 100:√3 -100:3	30 VA cl. 0.5	50 VA 3P	VRQ3n/S2	AAD62588	
				50 VA cl. 0.5		VRQ3n/S2	AAD62589	
				100 VA cl. 0.5		VRQ1n/S2	03811760N0	
		11000:√3 / 110:√3 -110:3	30 VA cl. 0.5	50 VA 3P	VRQ3n/S2	AAD62594		
			50 VA cl. 0.5		VRQ3n/S2	AAD62595		
			100 VA cl. 0.5		VRQ1n/S2	03811761N0		
	38	95	13800:√3 / 110:√3 -110:3	30 VA cl. 0.5	50 VA 3P	VRQ3n/S2	03811762N0	
				50 VA cl. 0.5		VRQ3n/S2	03811763N0	
				100 VA cl. 0.5		VRQ1n/S2	03811764N0	
			15000:√3 / 100:√3 -100:3	30 VA cl. 0.5	50 VA 3P	VRQ3n/S2	AAD62591	
				50 VA cl. 0.5		VRQ3n/S2	AAD62592	
				100 VA cl. 0.5		VRQ1n/S2	03811765N0	
24	44	125	15000:√3 / 100:√3 -100:3	30 VA cl. 0.5	50 VA 3P	VRQ2n/S2	03811766N0	
				50 VA cl. 0.5		VRQ2n/S2	03811767N0	
				100 VA cl. 0.5		VRQ1n/S2	03811768N0	
	50	125	20000:√3 / 100:√3 -100:3	30 VA cl. 0.5	50 VA 3P	VRQ2n/S2	03811769N0	
				50 VA cl. 0.5		VRQ2n/S2	03811770N0	
				100 VA cl. 0.5		VRQ1n/S2	03811771N0	
			22000:√3 / 110:√3 -110:3	30 VA cl. 0.5	50 VA 3P	VRQ2n/S2	03811772N0	
				50 VA cl. 0.5		VRQ2n/S2	03811773N0	
				100 VA cl. 0.5		VRQ1n/S2	03811774N0	
36	70	170	30000:√3 / 100:√3 -100:3	50 VA 3P	VRF3n/S2	03811775N0		
			33000:√3 / 110:√3 -110:3	50 VA 3P	VRF3n/S2	03811776N0		

Single secondary metering VT

Frequency: 50 - 60 Hz

Rated voltage kV	Power frequency withstand kV-1 min	Lightning impulse withstand kV-peak	Transformation ratio V / V	Power and accuracy class (double use)	Type	Reference	Qty
7.2	9	60	$3000:\sqrt{3} / 100:\sqrt{3}$	30 VA cl. 0.5	VRS3n/S1	AAD62597	
	10		$3300:\sqrt{3} / 110:\sqrt{3}$		VRS3n/S1	AAD62603	
	15		$5000:\sqrt{3} / 100:\sqrt{3}$		VRS3n/S1	AAD62599	
	16		$5500:\sqrt{3} / 110:\sqrt{3}$		VRS3n/S1	AAD62605	
	20		$6000:\sqrt{3} / 100:\sqrt{3}$		VRS3n/S1	AAD62601	
12	20	75	$6000:\sqrt{3} / 100:\sqrt{3}$	30 VA cl. 0.5	VRS3n/S1	AAD62609	
			$6600:\sqrt{3} / 110:\sqrt{3}$		VRS3n/S1	AAD62613	
	28		$10000:\sqrt{3} / 100:\sqrt{3}$		VRS3n/S1	AAD62611	
			$11000:\sqrt{3} / 110:\sqrt{3}$		VRS3n/S1	AAD62615	
			30		$10000:\sqrt{3} / 100:\sqrt{3}$	30 VA cl. 0.5	VRS3n/S1
17.5	32	$11000:\sqrt{3} / 110:\sqrt{3}$	30 VA cl. 0.5	VRS3n/S1	AAD62621		
	38	$15000:\sqrt{3} / 100:\sqrt{3}$	30 VA cl. 0.5	VRS3n/S1	AAD62619		
	24	44	125	$15000:\sqrt{3} / 100:\sqrt{3}$	30 VA - 50 VA cl. 0.5	VRS2Bn/S1	03811885N0
				100 VA cl. 0.5	VRS2Bn/S1	03811886N0	
50		$20000:\sqrt{3} / 100:\sqrt{3}$		30 VA - 50 VA cl. 0.5	VRS2Bn/S1	03811887N0	
		100 VA cl. 0.5		VRS2Bn/S1	03811888N0		
		$22000:\sqrt{3} / 110:\sqrt{3}$		30 VA - 50 VA cl. 0.5	VRS2Bn/S1	03811889N0	
			100 VA cl. 0.5	VRS2Bn/S1	03811890N0		

Double secondary metering and protection VT

Frequency: 50 - 60 Hz

Rated voltage kV	Power frequency withstand kV-1 min	Lightning impulse withstand kV-peak	Transformation ratio V / V	Power, accuracy class for metering secondary (double use)	Power, accuracy class for protection secondary	Type	Reference	Qty
7.2	9	60	$3000:\sqrt{3} / 100:\sqrt{3}-100:3$	30 VA cl. 0.5	30 VA 3P	VRS3n/S2	03811891N0	
	10		$3300:\sqrt{3} / 110:\sqrt{3}-110:3$			VRS3n/S2	03811892N0	
	15		$5000:\sqrt{3} / 100:\sqrt{3}-100:3$			VRS3n/S2	03811893N0	
	16		$5500:\sqrt{3} / 110:\sqrt{3}-110:3$			VRS3n/S2	03811894N0	
	20		$6000:\sqrt{3} / 100:\sqrt{3}-100:3$			VRS3n/S2	03811895N0	
12	20	75	$6000:\sqrt{3} / 100:\sqrt{3}-100:3$	30 VA cl. 0.5	30 VA 3P	VRS3n/S2	03811897N0	
			$6600:\sqrt{3} / 110:\sqrt{3}-110:3$			VRS3n/S2	03811898N0	
	28		$10000:\sqrt{3} / 100:\sqrt{3}-100:3$			VRS3n/S2	03811899N0	
			$11000:\sqrt{3} / 110:\sqrt{3}-110:3$			VRS3n/S2	03811900N0	
			30			$10000:\sqrt{3} / 100:\sqrt{3}-100:3$	30 VA cl. 0.5	30 VA 3P
17.5	32	$11000:\sqrt{3} / 110:\sqrt{3}-110:3$	30 VA cl. 0.5	30 VA 3P	VRS3n/S2	03811902N0		
	38	$13800:\sqrt{3} / 110:\sqrt{3}-110:3$	30 VA cl. 0.5	30 VA 3P	VRS3n/S2	03811903N0		
		$15000:\sqrt{3} / 100:\sqrt{3}-100:3$	30 VA cl. 0.5	30 VA 3P	VRS3n/S2	03811904N0		
24	44	125	$15000:\sqrt{3} / 100:\sqrt{3}-100:3$	30 VA cl. 0.5	50 VA 3P	VRS2Bn/S2	03811905N0	
			$15000:\sqrt{3} / 100:\sqrt{3}-100:3$	50 VA cl. 0.5		VRS2Bn/S2	03811906N0	
	$15000:\sqrt{3} / 100:\sqrt{3}-100:3$		100 VA cl. 0.5	VRS2Bn/S2		03811907N0		
	$20000:\sqrt{3} / 100:\sqrt{3}-100:3$		30 VA cl. 0.5	VRS2Bn/S2		03811908N0		
			50 VA cl. 0.5	VRS2Bn/S2		03811909N0		
	50			$20000:\sqrt{3} / 100:\sqrt{3}-100:3$	100 VA cl. 0.5	VRS2Bn/S2	03811910N0	
				$22000:\sqrt{3} / 110:\sqrt{3}-110:3$	30 VA cl. 0.5	VRS2Bn/S2	03811911N0	
					50 VA cl. 0.5	VRS2Bn/S2	03811912N0	
					100 VA cl. 0.5	VRS2Bn/S2	03811913N0	
						VRS2Bn/S2		

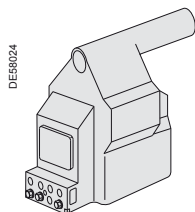

VRS3
Dimensions page 48

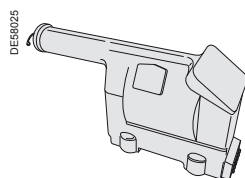

VRS2B

Order form

Installation structure for phase-earth VT with fuse-holder

Technical description

The mobile installation structure, ready to be assembled for phase earth voltage transformers with fuse-holders comprises the following components:

- movement selector for the internal part
- movement control arm
- movement selector for the external plastic cover
- torsion spring selector
- self-adhesive VT mimic diagram
- control panel
- 12 contact entrelec unit
- contact rod
- self-adhesive VT indicator mimic diagram.

Type	Reference	Qty
Kit VT	AAD62630	

Example of a voltage transformer compartment

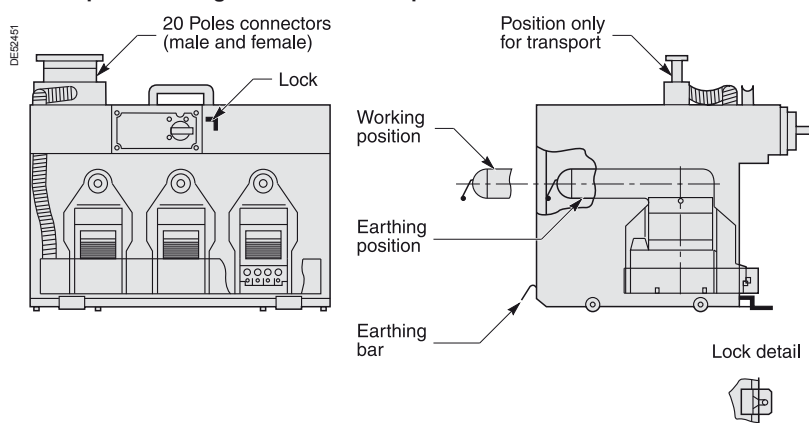

Single secondary metering VT

Frequency: 50 - 60 Hz

Rated voltage kV	Power frequency withstand kV-1 min	Lightning impulse withstand kV-peak	Transformation ratio V / V	Power and accuracy class (double use)	Type	Reference	Qty	
7.2	15	60	3000 / 100	50 VA cl. 0.5	VRCR/S1	03811801N0		
				100 VA cl. 0.5	VRC1/S1	03811802N0		
	20	60	3300 / 110	50 VA cl. 0.5	VRCR/S1	03811803N0		
				100 VA cl. 0.5	VRC1/S1	03811804N0		
			5000 / 100	50 VA cl. 0.5	VRCR/S1	03811805N0		
				100 VA cl. 0.5	VRC1/S1	03811806N0		
			5500 / 110	50 VA cl. 0.5	VRCR/S1	03811807N0		
				100 VA cl. 0.5	VRC1/S1	03811808N0		
	6000 / 100	60	6000 / 100	50 VA cl. 0.5	VRCR/S1	03811809N0		
				100 VA cl. 0.5	VRC1/S1	03811810N0		
	12	28	75	6000 / 100	50 VA cl. 0.5	VRCR/S1	03811813N0	
					100 VA cl. 0.5	VRC1/S1	03811814N0	
			6600 / 110	50 VA cl. 0.5	VRCR/S1	03811815N0		
				100 VA cl. 0.5	VRC1/S1	03811816N0		
10000 / 100			50 VA cl. 0.5	VRCR/S1	03811817N0			
			100 VA cl. 0.5	VRC1/S1	03811818N0			
11000 / 110			50 VA cl. 0.5	VRCR/S1	03811819N0			
			100 VA cl. 0.5	VRC1/S1	03811820N0			
17.5	38	95	10000 / 100	50 VA cl. 0.5	VRC1/S1	03811821N0		
				100 VA cl. 0.5	VRC1/S1	03811822N0		
			11000 / 110	50 VA cl. 0.5	VRC1/S1	03811823N0		
				100 VA cl. 0.5	VRC1/S1	03811824N0		
			13800 / 100	50 VA cl. 0.5	VRC1/S1	03811825N0		
				100 VA cl. 0.5	VRC1/S1	03811826N0		
			15000 / 100	50 VA cl. 0.5	VRC1/S1	03811827N0		
				100 VA cl. 0.5	VRC1/S1	03811828N0		
24	50	125	15000 / 100	50 VA cl. 0.5	VRC2/S1	03811829N0		
				100 VA cl. 0.5	VRC2/S1	03811830N0		
			20000 / 100	50 VA cl. 0.5	VRC2/S1	03811831N0		
				100 VA cl. 0.5	VRC2/S1	03811832N0		
			22000 / 110	50 VA cl. 0.5	VRC2/S1	03811833N0		
				100 VA cl. 0.5	VRC2/S1	03811834N0		
36	70	170	30000 / 100	50 VA cl. 0.5	VRL3/S1	03813376N0		
				100 VA cl. 0.5	VRL3/S1	03813377N0		
			33000 / 110	50 VA cl. 0.5	VRL3/S1	03813378N0		
				100 VA cl. 0.5	VRL3/S1	03813379N0		

DE59026

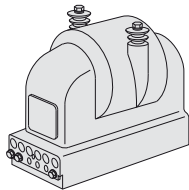

VRC1

Dimensions page 48

DE59027

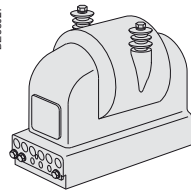

VRC2

DE59028

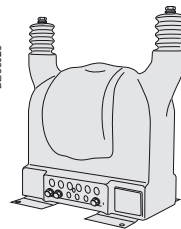

VRL3

VDF12

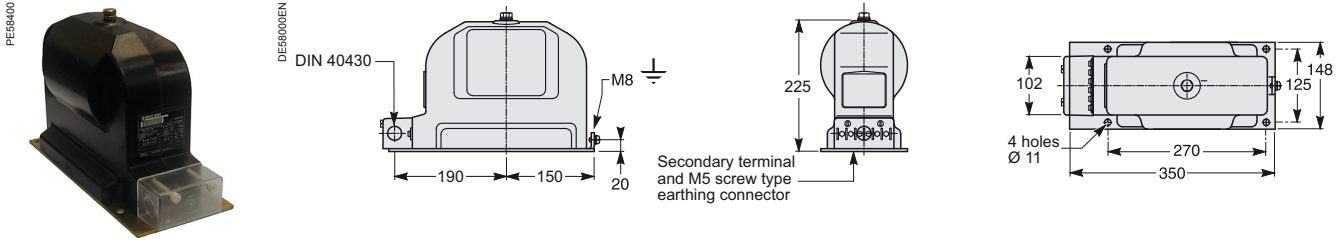

VDF21

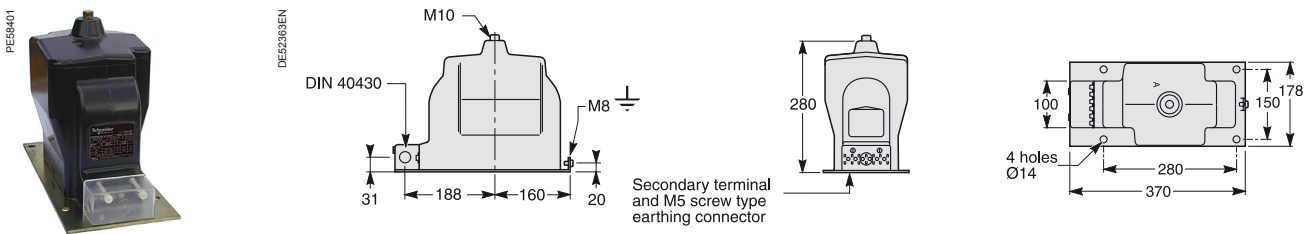

VDC11

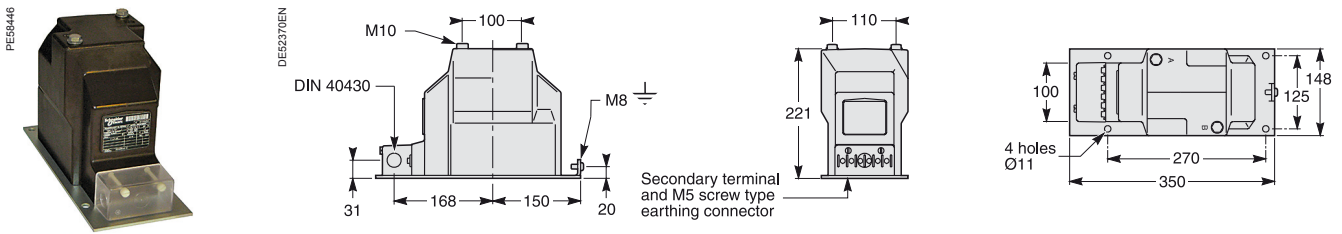

VDC21

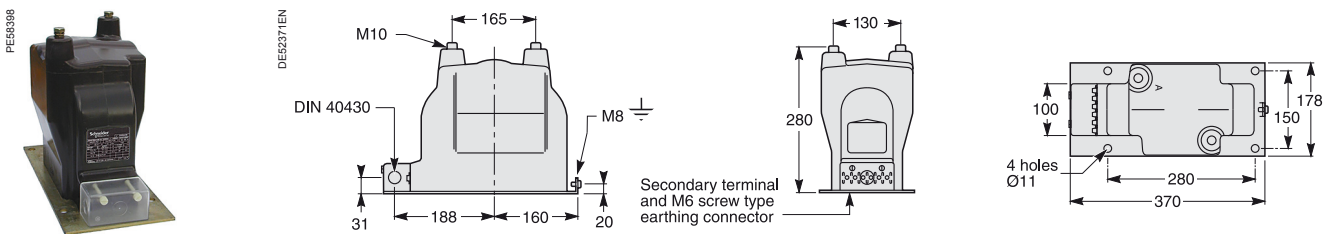

VRFR

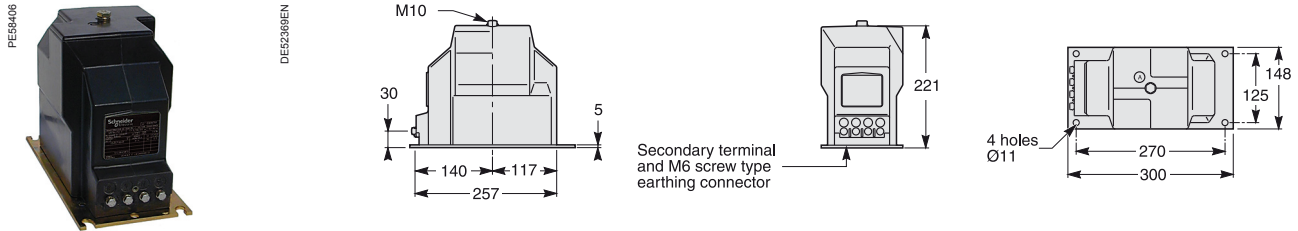

VRQ1

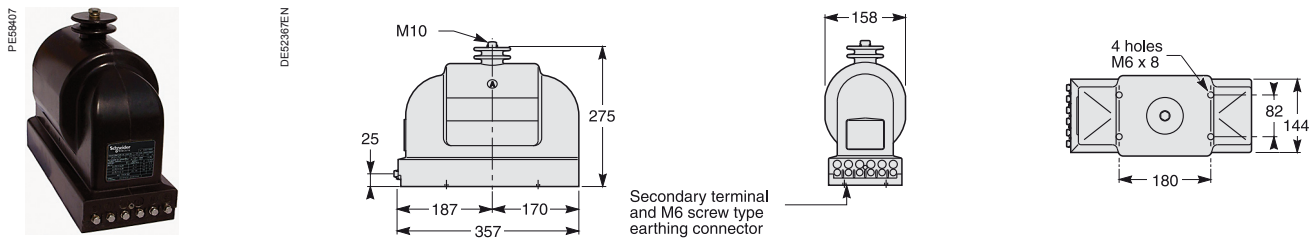

VRQ2

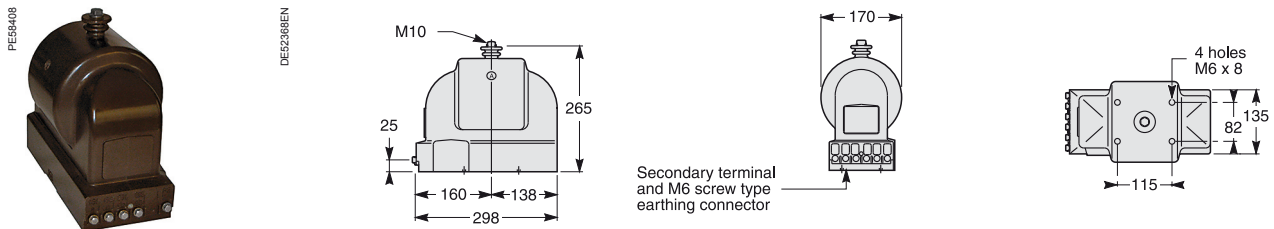

VRQ3

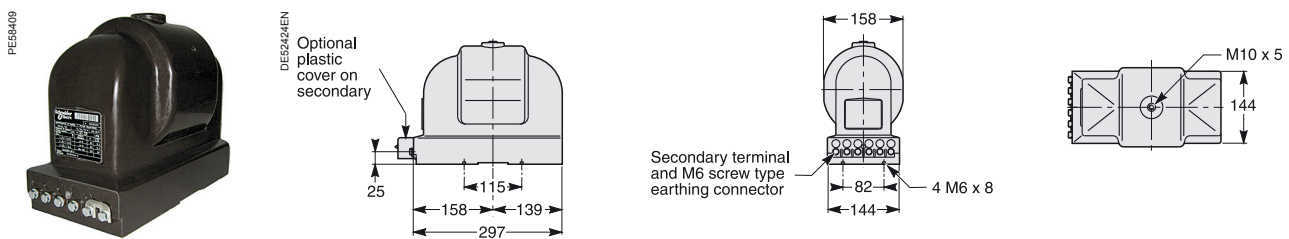

VRF3

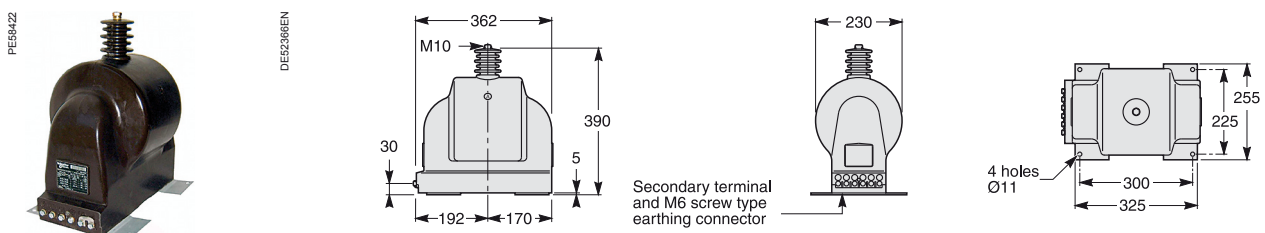

Dimensions

Phase-earth VT with fuse-holder

Phase-phase VT

VRS3

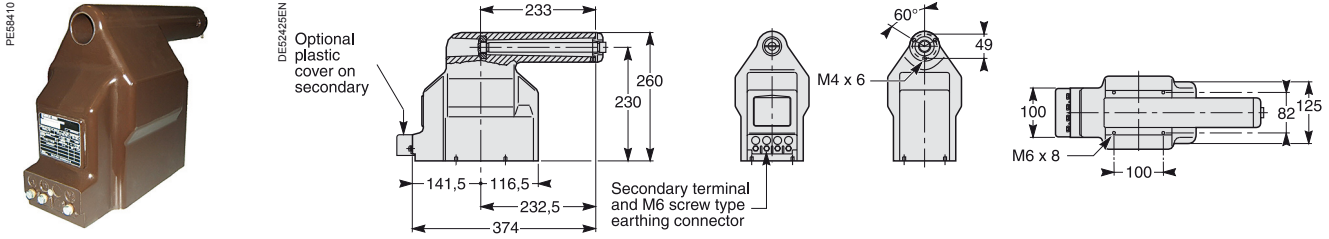

VRS2B

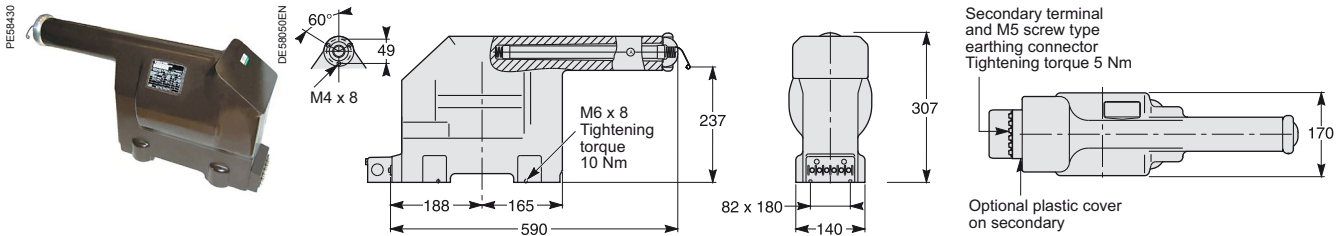

VRCR

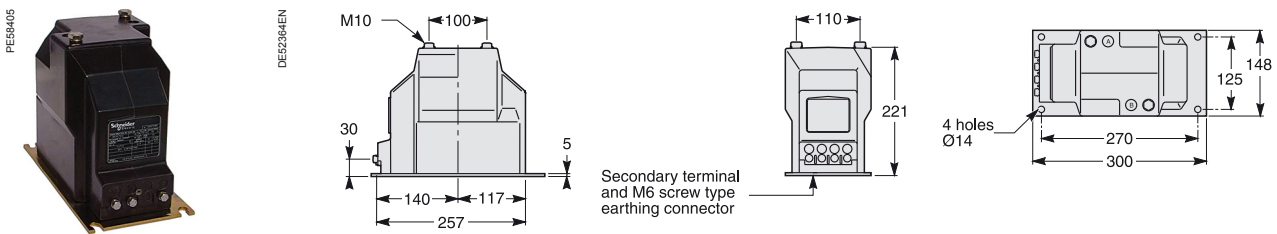

VRC1

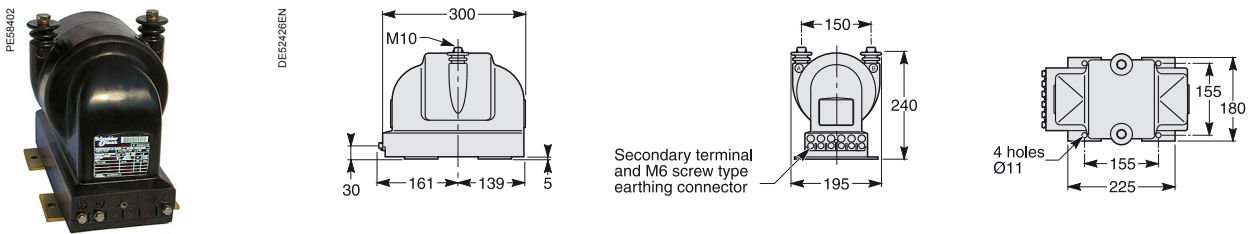

VRC2

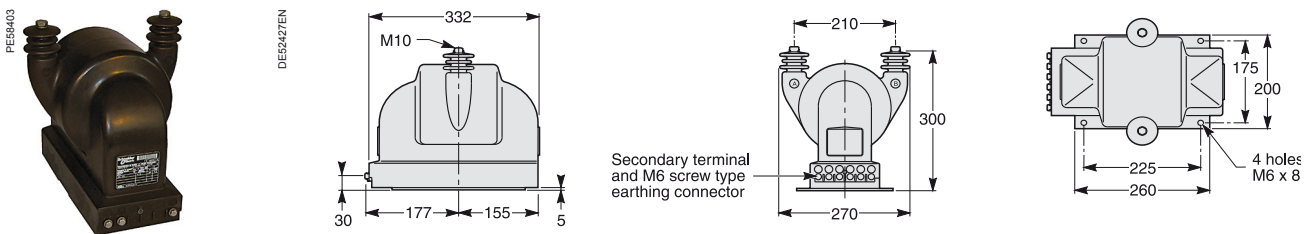

VRL3

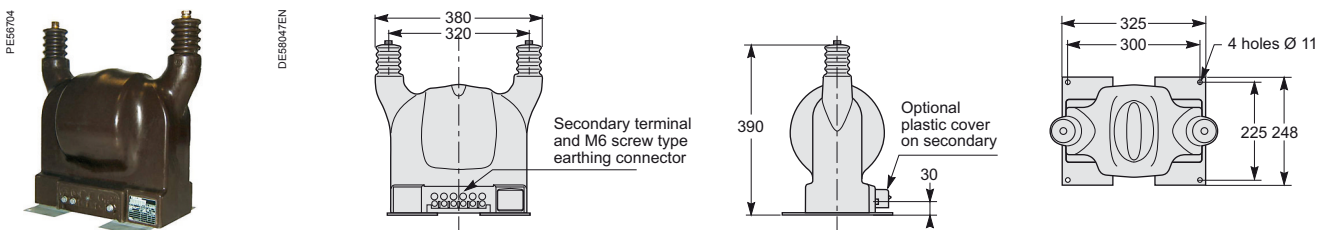

Notes

Notes

Schneider Electric Industries SAS

335, rue Joseph Monier
CS 30323
F - 92506 Rueil Malmaison Cedex (France)
Tel.: +33 (0)1 41 29 70 00
RCS Nanterre 954 503 439
Capital social 896 313 776 €
www.schneider-electric.com

AMTED300031EN

As standards, specifications and designs change from time to time, please ask for confirmation of the information given in this publication.

Design: Schneider Electric Industries SAS
Photos: Schneider Electric Industries SAS
Printed: Altavia Connexion - Made in France



 This document has been printed on recycled paper

01-2012