



Tri-rod cylinder—TCL, TCM Series

Product series

Page	Series name	Acting type	Bore size	Collocation of sensor switch	
				Double acting	
314		419			

Installation and application

- When load changes in the work, the cylinder with abundant output capacity shall be selected.
- Relative cylinder with high temperature resistance or corrosion resistance shall be chosen under the condition of high temperature or corrosion.
- Necessary protection measure shall be taken in the environment with higher humidity, much dust or water drops, oil dust and welding dregs.
- Dirty substances in the pipe must be cleared away before cylinder is connected with pipeline to prevent the entrance of particles into the cylinder.
- The medium used by cylinder shall be filtered to 40 μ m or below.
- The cylinder shall avoid the influence of side load in operation to maintain the normal work of cylinder and extend the service life.
- Anti-freezing measure shall be adopted under low temperature environment to prevent moisture freezing.
- If the cylinder is dismantled and stored for a long time, please conduct anti-rust treatment to the surface. Anti-dust cap shall be inserted into the inlet and outlet ports. As the precision of the manufacture and guide is high, never dismantle the fixed block or cylinder cover without permission.

Safe load and torque

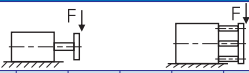
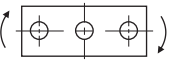
Bore size	Type	Stroke(mm)																	
		10	20	25	30	40	50	60	70	75	80	90	100	125	150	175	200	225	250
Max. safe load		Unit: Newton(N)																	
																			
12	TCM	44	33	29	26	41	36	30	28	26	25	24	22	19	17	-	-	-	-
	TCL	37	27	25	22	35	30	27	24	23	21	19	18	15	12	-	-	-	-
16	TCM	67	51	42	37	63	58	49	41	37	35	33	32	27	24	22	20	-	-
	TCL	54	40	37	32	54	47	42	38	35	32	30	28	23	20	17	15	-	-
20	TCM	-	78	61	57	123	112	99	91	67	84	79	75	66	59	54	49	45	42
	TCL	-	58	52	48	101	90	83	74	70	69	63	58	62	54	48	43	39	35
25	TCM	-	93	89	76	142	131	119	107	101	97	90	85	68	79	71	65	61	55
	TCL	-	82	79	68	132	118	109	99	93	88	81	77	80	70	62	55	50	45
32	TCM	-	-	203	190	179	164	221	197	182	172	163	157	142	127	116	106	98	91
	TCL	-	-	191	182	166	157	207	178	164	156	150	144	203	186	171	158	146	137
40	TCM	-	-	203	190	179	164	221	197	182	172	163	159	142	127	116	106	97	91
	TCL	-	-	190	182	166	157	210	179	163	156	150	144	203	185	171	158	146	137
50	TCM	-	-	296	283	268	245	303	288	273	266	253	241	216	195	179	164	155	142
	TCL	-	-	208	196	185	173	259	232	223	212	207	199	264	242	224	207	195	181
63	TCM	-	-	296	283	268	245	303	288	273	266	253	241	216	195	179	164	153	142
	TCL	-	-	206	196	180	171	259	232	221	212	205	196	262	240	221	205	191	178
Max. safe torque		Unit: Newton · Meter(N · m)																	
																			
12	TCM	0.90	0.79	0.71	0.65	0.77	0.72	0.65	0.53	0.50	0.47	0.41	0.36	0.31	0.27	-	-	-	-
	TCL	0.61	0.45	0.40	0.35	0.58	0.50	0.44	0.39	0.37	0.35	0.32	0.29	0.24	0.20	-	-	-	-
16	TCM	1.21	1.04	0.94	0.88	1.23	1.11	0.99	0.72	0.69	0.65	0.61	0.58	0.50	0.44	0.40	0.36	-	-
	TCL	0.99	0.74	0.66	0.59	0.99	0.86	0.77	0.69	0.65	0.61	0.57	0.52	0.43	0.37	0.32	0.28	-	-
20	TCM	-	1.57	1.42	1.31	2.39	2.15	1.97	1.90	1.88	1.86	1.72	1.63	1.44	1.28	1.16	1.06	1.01	0.90
	TCL	-	1.26	1.14	1.03	2.17	1.94	1.79	1.59	1.52	1.46	1.33	1.25	1.34	1.17	1.03	0.93	0.88	0.76
25	TCM	-	2.40	2.22	2.01	3.66	3.35	3.17	3.06	2.96	2.91	2.77	2.57	2.26	2.02	1.83	1.67	1.57	1.42
	TCL	-	2.11	1.96	1.75	3.37	3.02	2.71	2.42	2.38	2.33	2.19	1.97	2.05	1.78	1.58	1.41	1.22	1.16
32	TCM	-	-	6.35	6.00	5.73	5.13	5.98	5.74	5.69	5.62	5.11	4.97	4.42	3.98	3.61	3.31	2.97	2.84
	TCL	-	-	5.95	5.73	5.44	4.89	5.43	5.15	5.11	5.02	4.70	4.51	6.34	5.79	5.33	4.93	4.33	4.29
40	TCM	-	-	7.00	6.60	6.11	5.66	6.66	6.31	6.27	6.23	5.86	5.48	4.78	4.38	3.98	3.65	3.34	3.13
	TCL	-	-	6.55	6.21	5.77	5.39	6.17	5.67	5.62	5.58	5.33	4.96	6.98	6.38	5.87	5.43	5.00	4.72
50	TCM	-	-	13.00	12.60	11.00	10.80	13.70	12.70	12.00	11.80	11.10	10.80	9.50	8.60	7.86	7.24	6.80	6.24
	TCL	-	-	9.17	8.75	8.30	7.62	10.30	9.94	9.83	9.77	8.82	8.74	11.60	10.70	9.83	9.12	8.95	7.95
63	TCM	-	-	14.70	13.60	12.90	12.10	19.40	16.20	13.50	12.70	12.10	11.90	10.70	9.69	8.86	8.16	7.52	7.04
	TCL	-	-	10.20	9.74	9.20	8.48	17.50	14.00	11.00	10.60	10.20	9.74	13.00	11.90	11.00	10.20	9.63	8.84



Tri-rod cylinder



TCL,TCM Series



Symbol

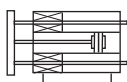

Product feature

- JIS standard is implemented.
- Two guides of special bearing steel and linear bearing or bronze bearing guide are used to prevent rotating. They can bear high torque and radial load.
★ Note: Steel ball linear bearing: It is suitable for elevation action of cylinder or the situation requiring high precision and high bearing ability, especially for the situation requiring low friction action process.
Bronze sliding bearing: it is suitable for the action that has radial load resistance. Compared with normal cylinder of same use, the horizontal impact resistance is doubled and it has stronger torsion rigidity.
- Drive unit and guide unit are in the same barrel that no additional accessories are needed with minimal space required. The air intake is optional and it is convenient to install.
- The bottom, back side and fixing plate of main body respectively has two exact orientation orifices (See ΦPA orifice and the orifice in XX point), which can provide orientation installation with high precision for the special situation.
- Options of switch mounting with provision 4 mounting slots.
- Special design of main body provides multi-mount;



TC

Specification

Bore size(mm)	12	16	20	25	32	40	50	63
Acting type	Double acting							
Fluid	Air(to be filtered by 40 μ m filter element)							
Operating pressure	0.1~1.0MPa(14~145psi)							
Proof pressure	1.5MPa(215psi)							
Temperature $^{\circ}C$	-20~70							
Speed range mm/s	30~500							
Stroke tolerance	$+1.0$ 0							
Cushion type	Bumper							
Non-rotating tolerance ①	Linear bearing	$\pm 0.08^{\circ}$	$\pm 0.07^{\circ}$	$\pm 0.06^{\circ}$	$\pm 0.05^{\circ}$	$\pm 0.06^{\circ}$	$\pm 0.06^{\circ}$	$\pm 0.06^{\circ}$
	Bronze bearing	$\pm 0.10^{\circ}$	$\pm 0.09^{\circ}$	$\pm 0.08^{\circ}$	$\pm 0.08^{\circ}$	$\pm 0.08^{\circ}$	$\pm 0.08^{\circ}$	$\pm 0.08^{\circ}$
Port size ②	M5 \times 0.8			1/8"		1/4"		1/4"

- ① Retract position.
② PT thread, NPT thread and G thread are available. Add) Refer to P419~442 for detail of sensor switch.

Stroke

Bore size (mm)	Standard stroke (mm)																Max. stroke	
12	10	20	25	30	40	50	60	70	75	80	90	100	125	150	150			
16	10	20	25	30	40	50	60	70	75	80	90	100	125	150	175	200	200	
20/25	20	25	30	40	50	60	70	75	80	90	100	125	150	175	200	225	250	250
32, 40, 50, 63	25	30	40	50	60	70	75	80	90	100	125	150	175	200	225	250	250	

Note) If non-standard stroke is ordered, backing plate will be added in the cylinder of standard stroke if the gap of the standard stroke and non-standard stroke is 1mm ($\Phi 12\sim\Phi 32$) or 5mm ($\Phi 40\sim\Phi 63$). For example, the non-standard stroke cylinder with a stroke of 28mm is transformed from the standard cylinder whose standard stroke is 30mm through adding a pad and their shape and dimension are the same.

Ordering code

TC M 50 \times 50 S

- Model**: TC: Tri-rod cylinder(Double acting type)
- Bearing type**: L: Linear bearing, M: Bronze bearing
- Bore size**: 12 16 20 25 32 40 50 63
- Thread type** ①: Blank: PT, T: NPT, G: G
- Magnet**: S: With magnet
- Stroke**: Refer to stroke table for details

① When the thread is standard, the code is blank. Add) TC Series are all with magnet.

How to mount

Fixation of screw on top surface

Fixation of screw at bottom surface

Fixation of T slot at bottom

Fixation of screw at back side

Orifice for leader

Bore size\Item	A	D(Min)
12	41	8
16	46	10
20	54	12
25	64	14
32	78	18
40	86	18
50	110	22
63	124	22



Tri-rod cylinder

TCL,TCM Series



Inner structure

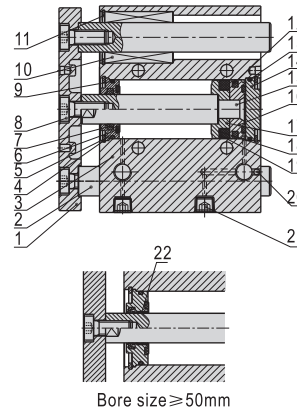

TCL

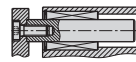

Bore size Φ 12、Φ 16mm
Stroke ≤ 30mm

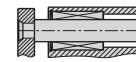

Bore size Φ 20 - Φ 63mm
Stroke ≤ 50mm

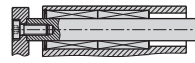

Bore size Φ 12、Φ 16mm
30 < Stroke ≤ 100mm

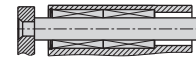

Bore size Φ 20 - Φ 63mm
50 < Stroke ≤ 100mm

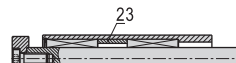

Bore size Φ 12、Φ 16mm
Stroke > 100mm

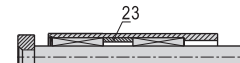

Bore size Φ 20 - Φ 63mm
Stroke > 100mm

TCM

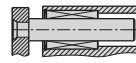

Bore size Φ 12 - Φ 63mm
Stroke ≤ 50mm

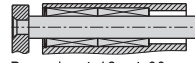

Bore size Φ 12 - Φ 63mm
50 < Stroke ≤ 100mm

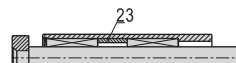

Bore size Φ 12 - Φ 63mm
Stroke > 100mm

NO.	Item	NO.	Item
1	Fixing plate	13	O-ring
2	Leader	14	Back cover
3	Body	15	Piston rod
4	C clip	16	Piston
5	Front cover	17	Magnet holder
6	Bumper	18	Magnet washer
7	Piston rod O-ring	19	Magnet
8	Screw	20	Screw
9	O-ring	21	Screw
10	Bearing	22	Bearing
11	C clip	23	Spacer
12	Piston seal		



TC



Tri-rod cylinder

TCL,TCM Series

■ Dimensions

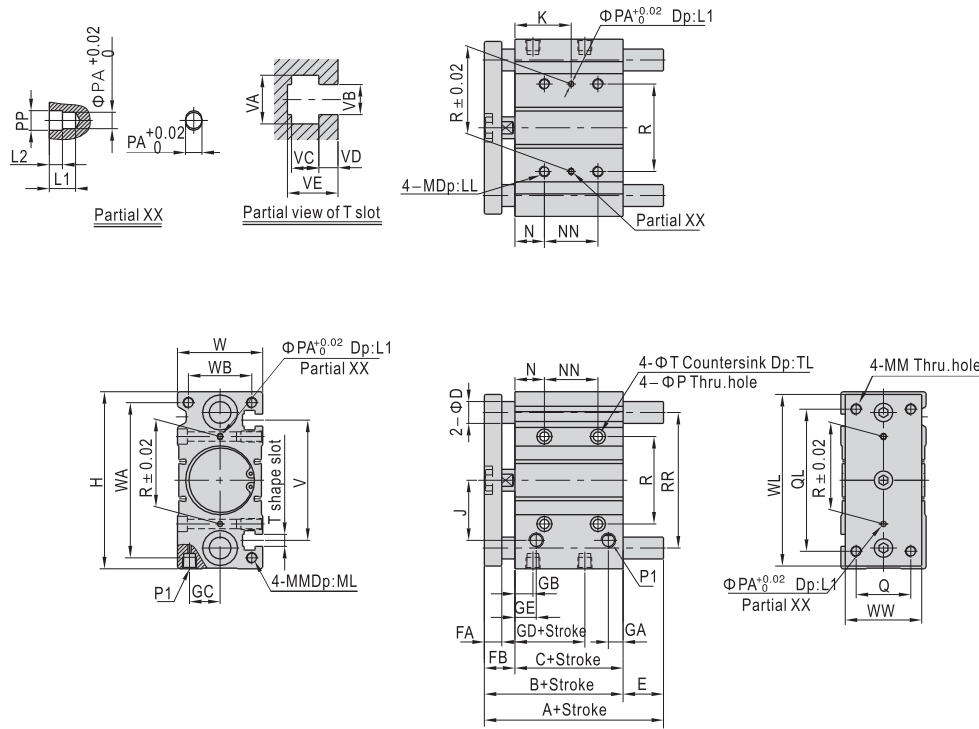

TC

Item	A												E				NN				K							
	Bore size			TCL			TCM			≤30		31~100		>200		≤30		31~100		>200		≤30		31~100		>200		
Stroke	≤30	31~100	101~200	>200	≤30	31~100	101~200	>200	≤50	51~100	101~200	>200	≤20	40	110	—	15	25	60	—	24	44	120	200	29	39	77	117
12	42	55	85	—	0	13	43	—	0	13	43	—	20	40	110	—	15	25	60	—	24	44	120	200	29	39	77	117
16	46	65	95	—	0	19	49	—	0	19	49	—	24	44	110	—	17	27	60	—	24	44	120	200	29	39	77	117
20	53	80	104	122	0	27	51	69	0	27	51	69	24	44	120	200	29	39	77	117	24	44	120	200	29	39	77	117
25	53.5	82	104.5	122	0	28.5	51	68.5	0	28.5	51	68.5	24	44	120	200	29	39	77	117	24	44	120	200	29	39	77	117

Item	A												E				NN				K							
	Bore size			TCL			TCM			≤40		41~100		>200		≤40		41~100		>200		≤40		41~100		>200		
Stroke	≤50	51~100	101~200	>200	≤50	51~100	101~200	>200	≤50	51~100	101~200	>200	≤24	48	124	200	33	45	83	121	24	48	124	200	34	46	84	122
32	65	102	118	140	5.5	42.5	58.5	80.5	5.5	42.5	58.5	80.5	24	48	124	200	33	45	83	121	24	48	124	200	34	46	84	122
40	66	102	118	140	0	36	52	74	0	36	52	74	24	48	124	200	34	46	84	122	24	48	124	200	34	46	84	122
50	76	118	134	161	4	46	62	89	4	46	62	89	24	48	124	200	36	48	86	124	24	48	124	200	36	48	86	124
63	77	118	134	161	0	41	57	84	0	41	57	84	28	52	128	200	38	50	88	124	28	52	128	200	38	50	88	124

Bore size\Item	B	C	FA	FB	P1	GA	GB	GC	GD	GE	R	RR	N	P	PA	PP	T	TL	M	LL
12	42	29	8	13	M5×0.8	7.5	11	8	13	11	23	41	5	4.3	3	3.5	8	4.5	M5×0.8	10
16	46	33	8	13	M5×0.8	8	11	10	15	11	24	46	5	4.3	3	3.5	8	4.5	M5×0.8	10
20	53	37	10	16	1/8"	9	10.5	10.5	12.5	10.5	28	54	17	5.6	3	3.5	9.5	5.5	M6×1.0	12
25	53.5	37.5	10	16	1/8"	9	11.5	13.5	12.5	11.5	34	64	17	5.6	4	4.5	9.5	5.5	M6×1.0	12
32	59.5	37.5	12	22	1/8"	9	12.5	15	7	12.5	42	78	21	6.6	4	4.5	11	7.5	M8×1.25	16
40	66	44	12	22	1/8"	10	14	18	13	14	50	86	22	6.6	4	4.5	11	7.5	M8×1.25	16
50	72	44	16	28	1/4"	11	12	21.5	9	14	66	110	24	8.6	5	6	14	9	M10×1.5	20
63	77	49	16	28	1/4"	13.5	16.5	28	14	16.5	80	124	24	8.6	5	6	14	9	M10×1.5	20

Bore size\Item	D(TCL)	D(TCM)	J	W	WA	WB	WL	WW	H	Q	QL	MM	ML	L1	L2	V	VA	VB	VC	VD	VE
12	6	8	18	26	50	18	56	22	58	14	48	M4×0.7	10	6	3	37	7.4	4.4	3.7	2	6.2
16	8	10	19	30	56	22	62	25	64	16	54	M5×0.8	12	6	3	38	7.4	4.4	3.7	2.5	6.7
20	10	12	25	36	72	24	81	30	83	18	70	M5×0.8	13	6	3	44	8.4	5.4	4.5	2.8	7.8
25	12	16	28.5	42	82	30	91	38	93	26	78	M6×1.0	15	6	3	50	8.4	5.4	4.5	3	8.2
32	16	20	34	48	98	34	110	44	112	30	96	M8×1.25	20	6	3	63	10.5	6.5	5.5	3.5	9.5
40	16	20	38	54	106	40	118	44	120	30	104	M8×1.25	20	6	3	72	10.5	6.5	5.5	4	11
50	20	20	47	64	130	46	146	60	148	40	130	M10×1.5	22	8	4	92	13.5	8.5	7.5	4.5	13.5
63	20	20	55	78	142	58	158	70	162	50	130	M10×1.5	22	8	4	110	17.8	11	10	7	18.5

