

TB3 SERIES COMMUNICATING THERMOSTATS

For 2-pipe and 4-pipe Fan Coil Units

Features

- Manual or automatic 3-speed fan control
- Proportional heating/cooling valves
- Auto, Heat, Cool and Ventilation modes
- Manual or automatic heating/cooling changeover
- Universal input for external sensor or windows/energy saving contact etc.
- Automatic heating/cooling changeover via changeover sensor
- User setpoint limitation
- Clock and time schedule functions
- Key lock
- Configurable user parameters
- BACnet MS/TP communication
- Modern styling and capacitive touch buttons
- Blue backlight LCD
- Different colour options; black and white
- EU box flush-mount

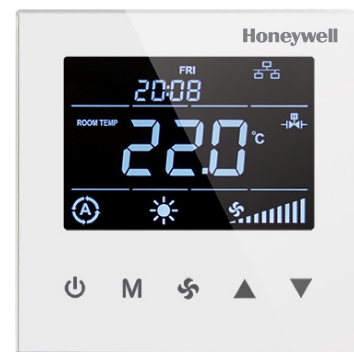

Applications

TB3 Series Fan Coil Thermostats used in individual rooms or zones in buildings. It is designed for two and four pipe fan coil units. TB3 Series has one universal input as external sensor or open/close contact input, three relay outputs, two analogue outputs and one EIA-485(BACnet MS/TP). It controls the fan coil unit depending on the internal room sensor or external return sensor temperature.

Notes on Usage

Please, read this datasheet carefully. TB3 Series thermostat safety rules in accordance with the latest technological developments designed and manufactured. To avoid injury and property damage safety warnings must be observed.

Security Advice-Caution

Assembly, maintenance, diagnostic and repair must be done by authorized service. The power supply of the device is 24 V AC/DC and it has no internal fuse. External protection with max C 5 A circuit breaker required in all cases. Disconnect from power supply before separating front plate.



Ordering Information

SPECIFICATIONS				
PRODUCT CODE	DESCRIPTION	COLOUR	POWER	COMMUNICATION
TB3240B/U	3 Digital Outputs (Relay) Fan Control 2 Analog Outputs (0-10V) Valve Control 1 Universal Input	Black	24 V AC/DC 50/60Hz	EIA-485(BACnet MS/TP)
TB3240W/U	3 Digital Outputs (Relay) Fan Control 2 Analog Outputs (0-10V) Valve Control 1 Universal Input	White	24 V AC/DC 50/60Hz	EIA-485(BACnet MS/TP)
TB3140B/U	3 Digital Outputs (Relay) Fan Control 2 Relay Output Valve Control 1 Universal Input	Black	220 VAC, 50/60Hz	EIA-485(BACnet MS/TP)
TB3140W/U	3 Digital Outputs (Relay) Fan Control 2 Relay outputs Valve Control 1 Universal Input	White	220Vac, 50/60Hz	EIA-485(BACnet MS/TP)

TECHNICAL SPECIFICATION	
FEATURE	RECOMMENDED
Power Supply	24V AC/DC 50/60Hz (for TB3240B/TB3240W) 100~220VAC 50/60Hz (for TB3140B/TB3140W)
Power Consumption	Max ~3.0 VA
Electrical Connection	Terminal Connectors
Battery for Real Time Clock (RTC)	Lithium CR1220 3.3V
Measuring Range	-10°C ... +100°C (+14°F ... +212°F)
Resolution	0.1°C (1°F)
Inputs	1 Universal Input (NTC 10K or Dry Contact)
Outputs	3 Digital Outputs (3 x 5 (2) A Relay) 2 Analog Outputs (0-10V)
Communication	1 x EIA-485(BACnet MS/TP)
Temperature Setting	5°C ... 40°C (Adjustable) (41°F ... 104°F (Adjustable)
Dimensions	86 x 86 x 52 mm
Mounting	Flush Mounted (Standard EU box)

Mounting Location

Thermostat is suggested to be installed indoor, a place with around 1.5m height above the floor where represents the average room temperature. It should be away from direct sunlight, any cover or any heat source, to avoid false signal for temperature control.



CAUTION: Power off supply at circuit breaker or fuse before installation to avoid fire, shock or death!

Dimension (mm)

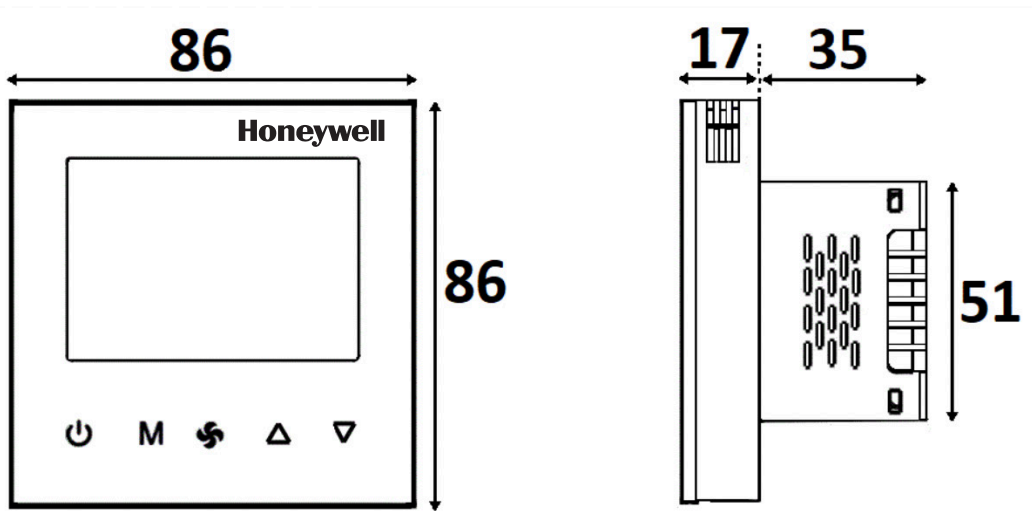

Mounting Location

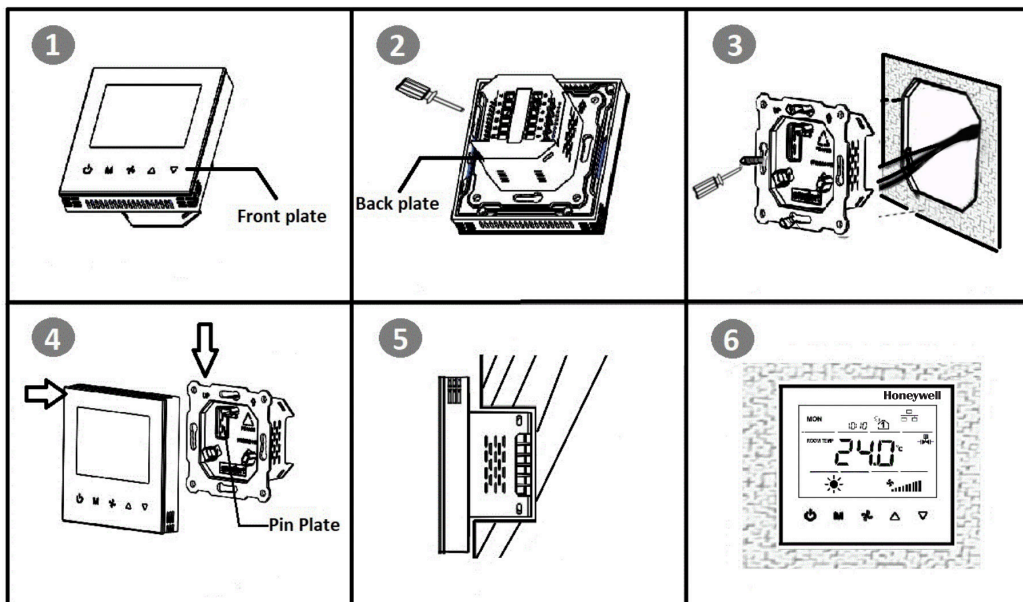

Note: This Communicating thermostat is suitable for mounting on Standard 75 * 75 * 47 mm Honeywell Recommended BACnet MS/TP cable part number Belden 3106A or equivalent

Please follow below instructions during mounting.

Step 1: Take the thermostat out from the package. Get the datasheet inside the package.

Step 2: Connect the wires well according to the wiring diagram below.

Step 3: Separate the front plate and the back plate, and then use screwdriver to fix the back plate into the electric box with 4 screws.

Step 4: Attach the front plate to the back plate, making sure the pin plates on each side are well matched.

Step 5: Refer to the picture after installation.

Step 6: Power on the thermostat to work.

Connection Diagrams

For TB3140 on/off connection diagram

Connection Diagram for 2-Pipe Fan Coil

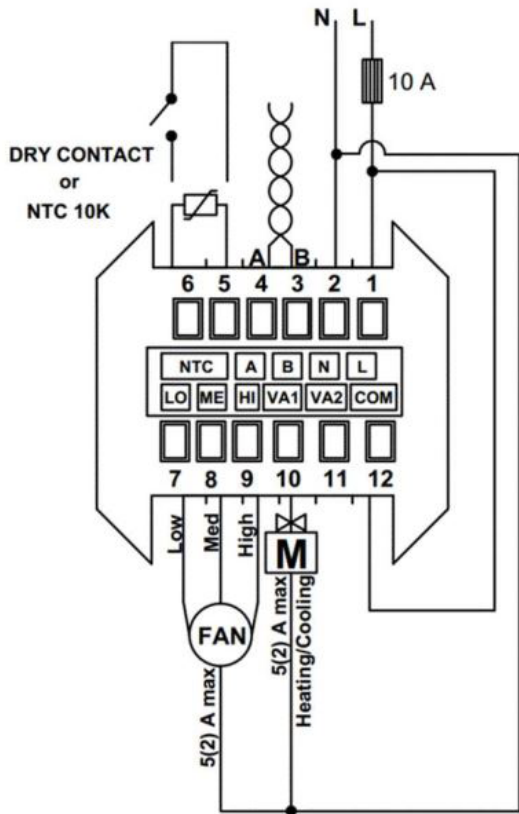

Connection Diagram for 4-Pipe Fan Coil

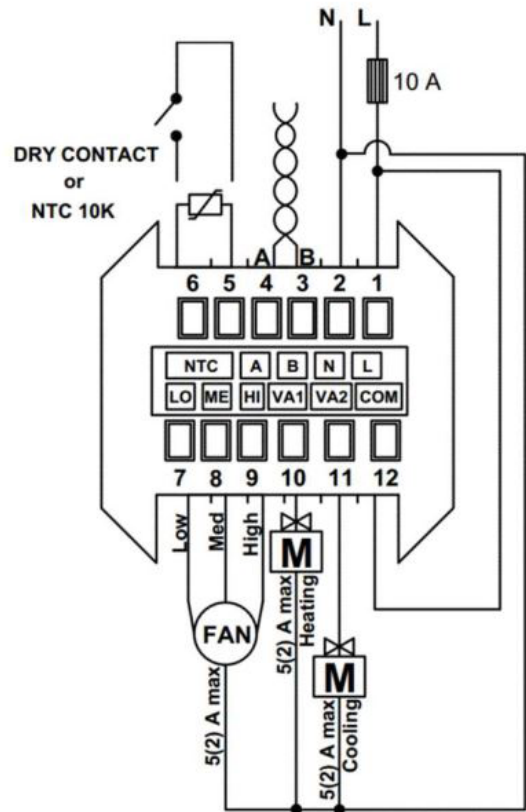

For TB3240 Modulating connection diagram

Connection Diagram for 2-Pipe Fan Coil

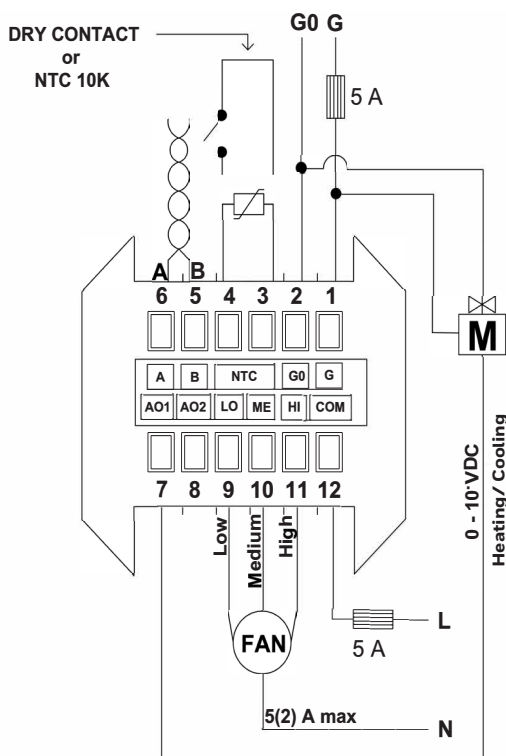

Connection Diagram for 4-Pipe Fan Coil

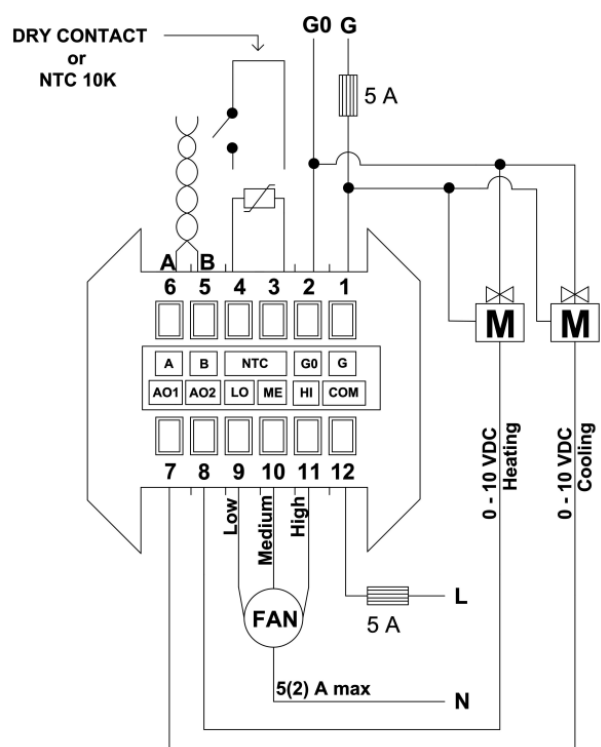

NOTE: Thermostat has no internal fuse. External protection with max C 5 A circuit breaker required in all cases. Isolate the cables of NTC – dry contact with G, G0 from 24 V power supply.

- 5A Fuse not included in Product supply

Display and Operations

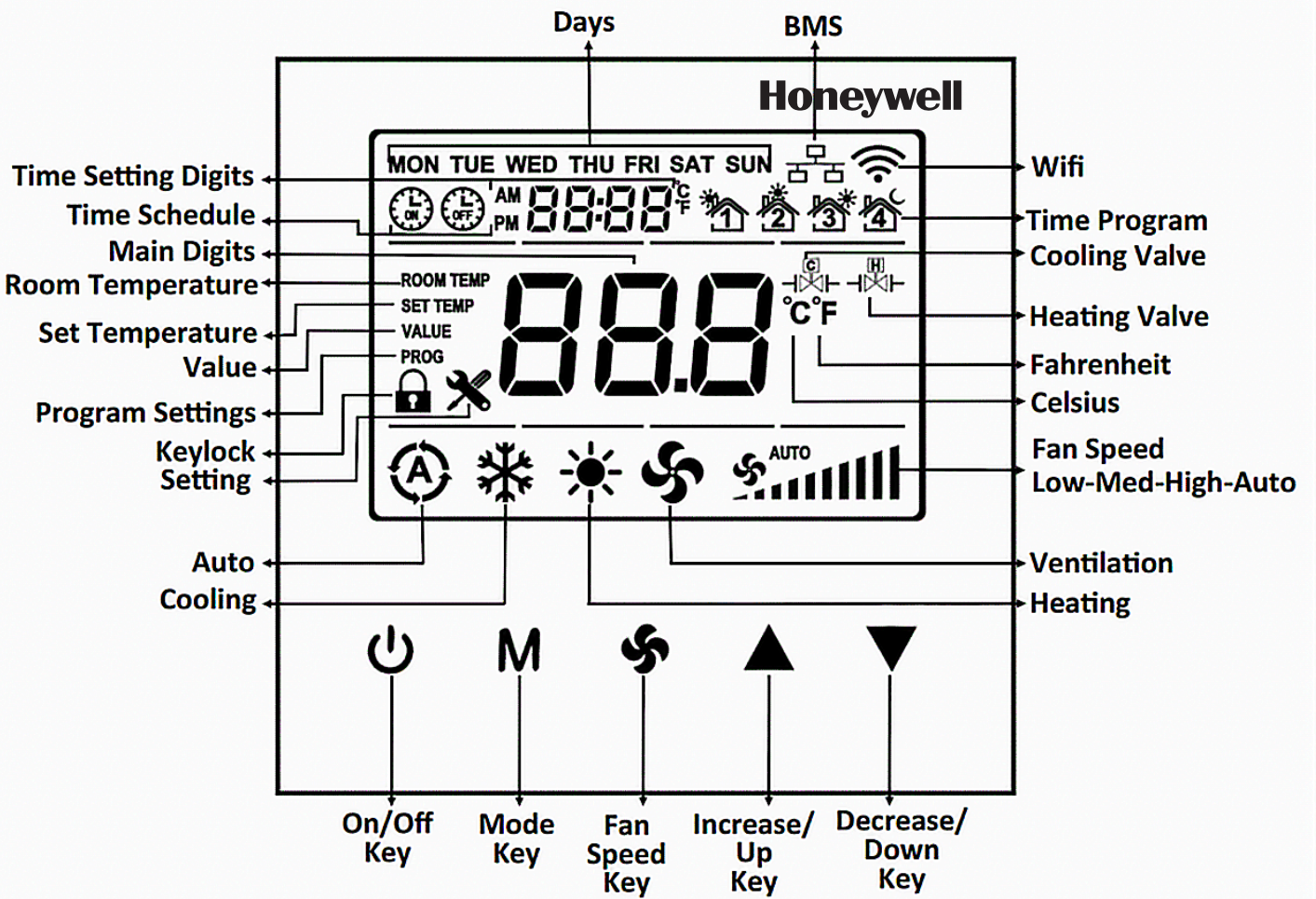

Mounting Location

- **Mode Selection:** When the “M” key is pressed, the mode change for 2-Pipe Systems is in the form of Cooling, Heating and Ventilation; Auto, Cooling, Heating and Ventilation for 4-Pipe Systems.
- **Fan Selection:** When the “” key is pressed, fan speed can be changed as Low, Med, High, Auto.
- **Time Setting:** When pressing the “M” key for 3 seconds, year digits flashes on the panel. “M” key is pressing once again, month digit flashes on the panel. “M” key is pressing once again, day digit flashes on the panel. “M” key is pressing once again, hour digit flashes on the panel. “M” key is pressing once again, minute digit flashes on the panel. “M” key is pressing once again, day of week digit flashes on the panel. Year, month, day, hour, minute, day of week can be changed by “▲” and “▼” keys.

Order: Year -> Month -> Day -> Hour -> Minute -> Day Of Week

- **Schedule Operations:** Be sure to set clock setting, before making schedule operation. After setting day, to enter the Schedule menu, press the “M” key one time. While in the Schedule menu, “Monday opening time hour digit” can be flashed. “M” key is pressing once again, “Monday opening time minute digit” flashes on the panel. Press the “M” key to enter the “Monday closing time hour digit” can be flashed. “M” key is pressing once again, “Monday closing time minute digit” flashes on the panel. While the digits flashing, hour and minute can be changed by “▲” and “▼” keys. Press the “M” key (one or more times) to select the other day of week.
- **Key Lock Operation:** When pressing “M” and “▲” key, key lock digit displays on the panel. The panel locked. When the panel is locked, press the “M” and “▲” keys to unlock panel. “Key Lock” options can be changed via parameter P6.

To lock two or more buttons at the same time; sum the numbers of the buttons. To lock mode key and on/off key, 1 (on/off) and 2 (mode) should be added and written 3. To lock setpoint and fan speed, 4 (setpoint) and 8 (fan speed) should be added and written 12.

Note : WiFi Icon is for future only

Configuration

Configuration Menu Description

When the device on or off position, press together “Main Parameter Increase Key” “M” and Value Decrease Key “▼” for 3 seconds, to enter the Configuration Menu. In the password screen, Password digits can be changed by Main Parameter Increase Key “M”, Password value can be changed by Value Increase Key “▲” and Value Decrease Key “▼” Password must be entered as “203” and Main Parameter Decrease Key “” must be pressed to confirm. When the correct password is written, the configuration menu will be entered. If the wrong password is entered, it will fail, and the password will reset. Password screen will return to main screen without an action 10 seconds. Parameter setting screen will return to main screen without any action in 30 seconds. All parameters are stored within an EEPROM ensuring no data loss if the Thermostat is powered off.

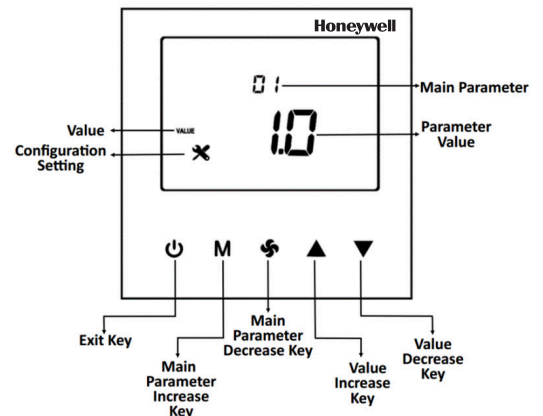

Universal Input (Parameter P32 or via BACnet)

External Sensor for room (parameter P32 = 1)

The device operates according to external temperature sensor value read from universal input.

- External Sensor (parameter P32 = 2)

The device operates according to internal temperature sensor value. The temperature read from the universal input can be monitored from P36.

- Changeover sensor (parameter P32 = 3)

If “Universal Input” value is selected as changeover, “dead zone” cannot be used.

Changeover sensor only valid when “Fan Coil Type” is set to 2.

When the water temperature is above P34 the thermostat changes over to heating mode.

It stays in heating mode until the temperature falls below P33.

When the water temperature is below P33, the thermostat changes over to cooling mode.

It stays in cooling mode until the temperature rises above P34.

- Windows contact/Energy saving-On/Off (NC Contact) (parameter P32 = 4)

When this contact is closed, the device is in the “ON” position. When this condition is not met, the device shows “OPEN” on the panel and the outputs of the device are passive.

- Windows contact/Energy saving-Off/On (NO Contact) (parameter P32 = 5)

When this contact is opened, the device is in the “ON” position. When this condition is not met, the device shows “OPEN” on the panel and the outputs of the device are passive.

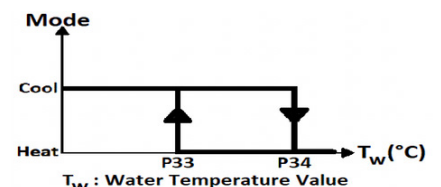

Hysteresis (Parameter P40 or via BACnet)

The output diagram of the valve according to the relation between TS and TR is given below.

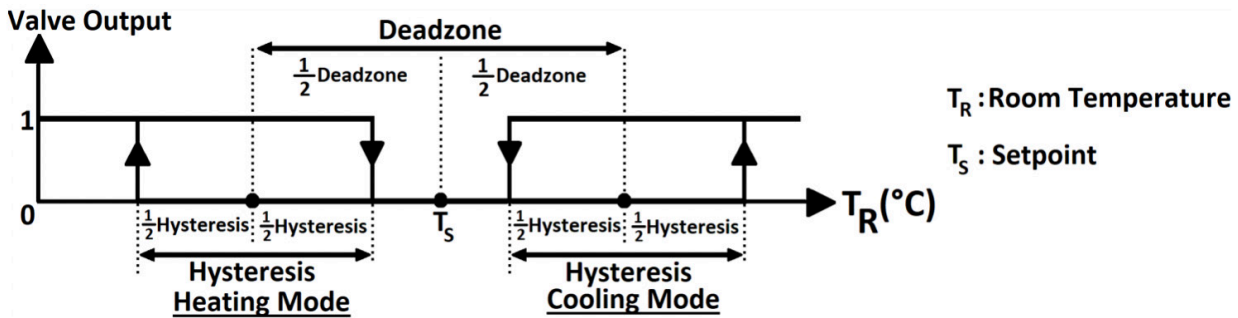

Fan/Valve Control Selection (Parameter P41 or via BACnet)

In valve independent mode, the fan operates according to manual fan selection or automatic fan control. When valve is closed, the fan will go on to operate.

In valve dependent mode, the fan will be closed when the valve is closed. If the valve is open, the fan will operate according to manual fan selection or automatic fan control.

Restore Factory Setting (Parameter P45 or via BACnet)

The device can load the factory setting parameters via parameter P45, by changing the value to "1", and pressing button "Exit Key" (⏻). The display shows top and bottom lines loaded step by step during reload process approximately 3 seconds.

Alarms

Alarm Code will appear on the screen, during alarm. If there is more than one alarm, alarms are shown alternately.

- Onboard Sensor Alarm

If the onboard sensor is broken down from the device displayed "AL01" on the panel and "Err" on the Main Digits. During the alarm, device outputs will be closed. During the alarm, if the "Universal Input" is selected to "External Sensor", the device continues normal operation.

- External Sensor Alarm

If the "Universal Input" is selected to "External Sensor" also the sensor is broken down, displayed "AL02" on the panel and "Err" on the Main Digits. During the alarm, device outputs will be closed. "Universal Input" is set to "Not Used" to eliminate the alarm.

- Changeover Sensor Alarm

If the "Universal Input" is selected to "Changeover Sensor" also the sensor is broken down, displayed "AL03" on the panel and "Err" on the Main Digits. During the alarm, device outputs will be closed. "Universal Input" is set to "Not Used" to eliminate the alarm.

Configuration Menu Parameters

NO	NAME OF PARAMETER	PARAMETER DEFINITION	FACTORY DEFAULT
P1	Hardware Version	Device hardware version	1.7
P2	Firmware Version	Device firmware version	1.0
P3	Setpoint High Limit	Range: 5°C ... 40°C (Range: 41°F ... 104°F)	30°C (86°F)
P4	Setpoint Low Limit	Range: 5°C ... 40°C (Range: 41°F ... 104°F)	5°C (41°F)
P5	Main Screen	0 = Room temperature 1 = Setpoint temperature 2 = Swap Room Temperature and Setpoint Temperature	0

P6	Key Lock	0 = Unlocked 1 = Lock On/Off 2 = Lock Mode 4 = Lock Setpoint 8 = Lock Fan Speed 16 = Lock Time Settings 32 = Lock Time Schedule Settings 63 = Locked All (*) To lock two or more buttons at the same time; sum the numbers of the buttons. To lock setpoint and fan speed, 4 (Setpoint) and 8 (Fan Speed) should be added and written 12.	0
P7	Celsius or Fahrenheit	0 = Celsius 1 = Fahrenheit	0
P8	Time Format	0 = 24 hours clock 1 = 12 hours clock (AM/PM) (*) The system Time Format is 24 hours clock. This parameter adjusts how to clock format on the panel/screen will shows.	1
P9	Time Schedule Enable	0 = Disable 1 = Enable	1
P10	Screen Saver	0 = Screen Saver Disabled 1 = Display On 2 = Display Off 3 = Only Room Temperature 4 = Room Temperature and Clock 5 = Swap Room Temperature and Setpoint with Clock	4
P11	Screen Saver Mode Delay	Range: 10 ... 150 seconds	60 sec.
P12	LCD Brightness	Range: 1 ... 5 stage	5
P13	Buzzer Stage	Range: 0 ... 5 stage	3
P14	Power Failure	This parameter adjusts the condition that the device will continue when the power failure. 0 = Device starts off 1 = Device starts on 2 = Keep State Before Power Failure	2
P15	Screen Off State Status	0: Screen off 1: Room Temperature 2: Room Temperature and Off 3: Room Temperature and Clock	1
P16	Valve Proportional Band	This parameter determines proportionally the output value of the valve depending on the difference between Room Temperature and Set Point. Range: 1 ... 100 => 0.1°C ... 10°C	20
P17 P29	Reserved	-	-
P30	Fan Coil Type	2 = 2 pipe system 4 = 4 pipe system	4
P31	Internal Temperature Sensor Calibration	Range: -10°C ... 10°C and 0.1°C steps (Range: -18°F ... 18°F and 1°F steps)	0°C (0°F)
P32	Universal Input	0 = Not used 1 = External Temperature sensor for room (NTC 10K) 2 = External Temperature sensor (NTC 10K) 3 = Changeover sensor (NTC 10K) 4 = Windows contact/Energy saving-On/Off (NC Contact) 5 = Windows contact/Energy saving-Off/On (NO Contact)	0
P33	Changeover Temperature for Cooling	Range: 10°C ... 25°C. Only valid when P32 is set to 3 (Range: 50°F ... 77°F. Only valid when P32 is set to 3)	16°C (60°F)
P34	Changeover Temperature for Heating	Range: 26°C ... 45°C. Only valid when P32 is set to 3 (Range: 78°F ... 113°F. Only valid when P32 is set to 3)	28°C (82°F)
P35	Mode Change Delay	Range: 0 ... 255 minutes	3 min.
P36	Universal Input Temperature	If P32 is "1", "2" or "3", this parameter shows the sensor temperature.	0°C (0°F)
P37	Universal Input Temperature Calibration	Range: -10°C ... 10°C and 0.1°C steps (Range: -18°F ... 18°F and 1°F steps)	0°C (0°F)
P38	Auto Mode Enable	0 = Disable (Only valid when P30 is set to 4) 1 = Enable	1

P39	Dead Zone	Range: 0°C ... 15°C. Only valid when P38 is set to 1 (Range: 0°F ... 27°F. Only valid when P38 is set to 1)	2°C (3°F)
P40	Hysteresis	Range: 0°C ... 15°C (Range: 0°F ... 27°F)	1°C (1°F)
P41	Fan/Valve Control Selection	0 = Valve independent 1 = Valve dependent	1
P42	Fan Stage Change Delay	Range: 0 ... 5 seconds	2 sec.
P43	Fan Off Delay	Range: 0 ... 60 seconds	0 sec.
P44	BMS Icon Enable	0 = Disable 1 = Enable	1
P45	Restore Factory Setting	0 = Factory Setting Disable 1 = Factory Setting Started	0
P46	Baudrate	1 = 9600bps 3 = 38400bps 2 = 19200bps 4 = 76800bps	1
P48	MAC Address	Range: 001 ... 127	1
P49	Parameter Menu Password	Range: 001 ... 999 (Read Only)	203

BACnet Parameters

8, n, 1

MAC Address: 1 ... 127. **Default 1**

Baudrate : 9600, 19200, 38400, 76800. **Default 9600**

Note 1: The MAC address can be changed via configuration menu.

Note 2: Device Instance Number (Device ID) is automatically calculated as below;

Device ID = 856 * 1000 + MAC

For example: Mac: 13 => Device ID = 856 * 1000 + 13 = 856013

When the MAC address is changed via configuration menu, the Device ID is automatically recalculated to avoid network ID conflict.

As a property of Device Object, Device ID value is writable via BACnet between 0 and 4194302. Once the Device ID is changed via BACnet, Device ID automatic calculation mentioned above is ineffective.

Note 3: MAC address and baudrate changings will become effective after power off and power on.

End Of Line (EOL) Resistor

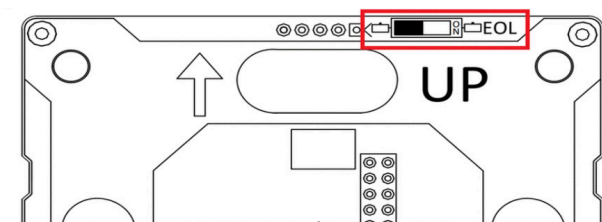

Flip the TB Series thermostat front plate, you will see the EOL resistor DIP Switch at the top right corner. The default is **OFF** position (Left). If you would like to enable EOL (120 Ohm) resistor, change it to **ON** Position (Right).



OFF Position



ON Position

TB3 Series BACnet Registers

NO	OBJECT	VALUE	OBJECT NAME	FUNCTION	DEFAULT	READ (R)/WRITE (W)
----	--------	-------	-------------	----------	---------	--------------------

Analog Inputs

1	Analog Input #1	-9.9°C ... 99.9°C (14.1°F ... 211.8°F)	Room Temperature	This parameter shows the room temperature value.	-	R
2	Analog Input #2	-9.9°C ... 99.9°C (14.1°F ... 211.8°F)	Universal Input Temperature	If "Universal Input" is "1", "2" or "3", this parameter shows the sensor temperature.	-	R

Analog Values

3	Analog Value #1	0 ... 3	Mode	0 = Fan Only 1 = Heat 2 = Cool 3 = Auto	3	R/W
4	Analog Value #2	1 ... 6	Fan Speed	1 = Stage 1 2 = Stage 2 3 = Stage 3 4 = Stage 4 5 = Stage 5 6 = Auto	1	R/W
5	Analog Value #3	Set Point Low Limit ... Set Point High Limit	Set Point	This parameter is the desired room temperature value.	21°C (69.8°F)	R/W
6	Analog Value #4	5°C ... 40°C (41°F ... 104°F)	Set Point High Limit	This parameter adjusts the high limit for desired room temperature.	30°C (86°F)	R/W
7	Analog Value #5	5°C ... 40°C (41°F ... 104°F)	Set Point Low Limit	This parameter adjusts the low limit for desired room temperature.	5°C (41°F)	R/W
8	Analog Value #6	0 ... 63	Key Lock	0 = Unlocked 1 = Lock On/Off 2 = Lock Mode 4 = Lock Setpoint 8 = Lock Fan Speed 16 = Lock Time Settings 32 = Lock Time Schedule Settings 63 = Locked All (*) To lock two or more buttons at the same time; sum the numbers of the buttons. To lock setpoint and fan speed, 4 (Setpoint) and 8 (Fan Speed) should be added and written 12.	0	R/W
9	Analog Value #7	0 ... 2	Power Failure	This parameter adjusts the condition that the device will continue when the power failure. 0 = Device starts off 1 = Device starts on 2 = Keep State Before Power Failure	2	R/W
10	Analog Value #8	2 ... 4	Fan Coil Type	2 = 2 Pipe System 4 = 4 Pipe System	4	R/W
11	Analog Value #9	-10°C ... 10°C (-18°F ... 18°F)	Internal Temperature Sensor Calibration		0°C (0°F)	R/W
12	Analog Value #10	0 ... 5	Universal Input	0 = Not Used 1 = External temperature sensor for room (NTC 10K) 2 = External sensor for room (NTC 10K) 3 = Changeover sensor (NTC 10K) 4 = Windows contact/Energy saving-On/Off (NC Contact) 5 = Windows contact/Energy saving-Off/On (NO Contact)	0	R/W
13	Analog Value #11	10°C ... 25°C (50°F ... 77°F)	Changeover Temperature for Cooling	If "Universal Input" is set to "3", this parameter adjusts changeover temperature for cooling mode.	16°C (60.8°F)	R/W
14	Analog Value #12	26°C ... 45°C (78.8°F ... 113°F)	Changeover Temperature for Heating	If "Universal Input" is set to "3", this parameter adjusts changeover temperature for heating mode.	28°C (82.4°F)	R/W
15	Analog Value #13	0 min. ... 255 min.	Mode Change Delay	This parameter adjusts delay time between heat and cool modes.	3 min.	R/W
16	Analog Value #14	-10°C ... 10°C (-18°F ... 18°F)	Universal Input Temperature Calibration		0°C (0°F)	R/W
17	Analog Value #15	0°C ... 15°C (0°F ... 27°F)	Dead Zone	If "Mode" is set to "Auto", this parameter adjusts dead zone.	2°C (3.6°F)	R/W
18	Analog Value #16	0°C ... 15°C (0°F ... 27°F)	Hysteresis	This parameter adjusts hysteresis.	1°C (1.8°F)	R/W
19	Analog Value #17	0 sec. ... 5 sec.	Fan Stage Change Delay	This parameter adjusts delay of the changing range the fan.	2 sec.	R/W
20	Analog Value #18	0 sec. ... 60 sec.	Fan Off Delay	This parameter adjusts delay of the closing time the fan.	0 sec.	R/W

21	Analog Value #19	0 ... 3	Fan Status	0 = Off 2 = Med 1 = Low 3 = High	0	R
22	Analog Value 20	1 ... 100	Valve Proportional Band	This parameter determines proportionally the output value of the fan depending on the difference between Room Temperature and Set Point. Range: 0.1°C ... 10°C	20	R/W
23	Analog Value #21	0 ... 100	VA1 State	0V.. 10V	0	0
24	Analog Value #22	0 ... 100	VA2 State	0V.. 10V	0	0
25	Analog Value #23	0 ... 3	Alarm	This parameter indicates the alarm state. 0 = No alarm 1 = Onboard Sensor Alarm 2 = External Sensor Alarm 3 = Changeover Sensor Alarm	0	R
26	Analog Value #24	2017 ... 2099	Current Year	This parameter adjusts the current year.	2019	R/W
27	Analog Value #25	1 ... 12	Current Month	This parameter adjusts the current month.	-	R/W
28	Analog Value #26	1 ... 31	Current Day	This parameter adjusts the current day.	-	R/W
29	Analog Value #27	00 ... 23	Current Hour	This parameter adjusts the current hour.	-	R/W
30	Analog Value #28	00 ... 59	Current Minute	This parameter adjusts the current minute.	-	R/W
31	Analog Value #29	1 ... 4	Baudrate	1 = 9600bps 2 = 19200bps 3 = 38400bps 4 = 76800bps	1	R/W
32	Analog Value #30	1 ... 999	Parameter Menu Password	This parameter is set to the password to be entered in the parameter menu.	203	R/W

Binary Inputs

33	Binary Input #1	0 ... 1	Universal Input Digital Input Value	0 = Off 1 = On	-	R
----	-----------------	---------	-------------------------------------	-------------------	---	---

Binary Values

34	Binary Value #1	0 ... 1	Start/Stop	0 = Stop 1 = Start	1	R/W
35	Binary Value #2	0 ... 1	Celsius or Fahrenheit	0 = Celsius 1 = Fahrenheit	0	R/W
36	Binary Value #3	0 ... 1	Auto Mode Enable	0 = Disable 1 = Enable	1	R/W
37	Binary Value #4	0 ... 1	Fan/Valve Control Selection	0 = Valve Independent 1 = Valve Dependent	1	R/W
38	Binary Value #5	0 ... 1	Restore Factory Setting	0 = Factory Setting Disable 1 = Factory Setting Started	0	R/W

For more information

<https://buildings.honeywell.com/>

**Honeywell Building Technologies
Building Management Systems**

Emaar Business Park, Sheikh Zayed Road Building
No. 2, 2nd floor, 201 Post Office Box 232362
Dubai, United Arab Emirates
Tel: +971 44541704

Honeywell Teknoloji A.Ş.

Cayir Cad. No:7 Kat:1
Icerenkoy 34752 Istanbul, Turkey
Tel: +90 216 578 71 10
Faks: +90 216 575 66 37

www.honeywell.com

© 2020 Honeywell International Inc.

**THE
FUTURE
IS
WHAT
WE
MAKE IT**

Honeywell