

Pneumatic miniclamp

SA25IC5524/5539

[Download datasheet](#)

[Go to 3D configurator](#)

Product image



Technical drawing

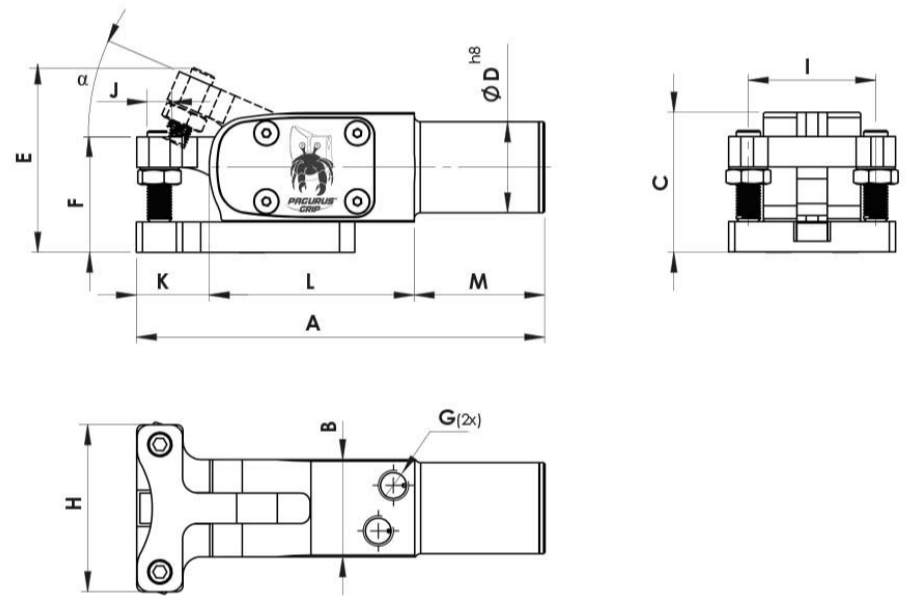

Material: Ergal 7075 & Steel

Treatment: Hard anodizing & Burnishing

Bolts: included

Type	SA25IC5524	SA25IC5539
Bore	25	25
Clamping force (6 bar)	160 daN	120 daN
Opening angle α	24°	24°
Air consumption per cycle (6 bar)	12,6 cm ³	12,6 cm ³
Weight (kg)	0,59	0,64

Technical data

COD.	A	B	C	ØD	E	F	G	H	I	J	K	L	M	N
------	---	---	---	----	---	---	---	---	---	---	---	---	---	---