

RM/28000/M, ISO cylinder

Magnetic piston, single acting

- > ø 10 ... 25 mm
- > Standard magnetic piston for full control system versatility
- > Conforming to ISO 6432
- > Optional port arrangement for compact installation
- > Nose mounting nut and piston rod locknut as standard



Technical features

Medium:

Compressed air, filtered, lubricated or non-lubricated

Standard:

ISO 6432

Operation:

Single acting (sprung in) with magnetic piston and buffer
 RM/28000/M Integral rear eye mounting
 RM/28500/MC Central rear port
 RM/28500/MF Flat rear cover

Operating pressure:

2 ... 10 bar (29 ... 145 psi)

Cylinder diameters:

10, 12, 16, 20, 25 mm

Strokes:

See page below

Non-standard strokes:

up to 50 mm max. on request

Operating temperature:

-10 ... +80°C max. (+14 ... +176°F)
 Air supply must be dry enough to avoid ice formation at temperatures below +2°C (+35°F).

Materials:

Barrel: stainless steel (austenitic)
 End covers: clear anodised aluminium alloy
 Piston rod: stainless steel (austenitic)
 Buffer: PUR
 Seals: NBR

Technical data

Cylinder ø (mm)	10	12	16	20	25
Port size	M5	M5	M5	G1/8	G1/8
Piston rod ø (mm)	4	6	6	8	10
Piston rod thread	M4	M6	M6	M8	M10x1,25
Theoretical thrusts at 6 bar outstroke (N)	40,7	57,7	102	165	260
Spring forces F1 instroke (N)	3,7	4,8	10,5	16,1	21,6
Air consumption at 6 bar outstroke (l/cm)	0,006	0,008	0,014	0,022	0,035

Standard strokes

Cylinder ø (mm)	Stroke length (mm)		
	10	25	50
10	•	•	•
12	•	•	•
16	•	•	•
20	•	•	•
25	•	•	•

Cylinder variants

Symbol	Model with magnetic piston	Description	Dimensions Page
	RM/28000/M	Standard cylinder with integral eye mounting	3
	RM/28000/MC	Cylinder with central rear port	3
	RM/28000/MF	Cylinder with flat rear cover	3

Option selector

Cylinder ø (mm)	Stroke (mm)	Substitute
10	max. 50	
12		
16		
20		
25		









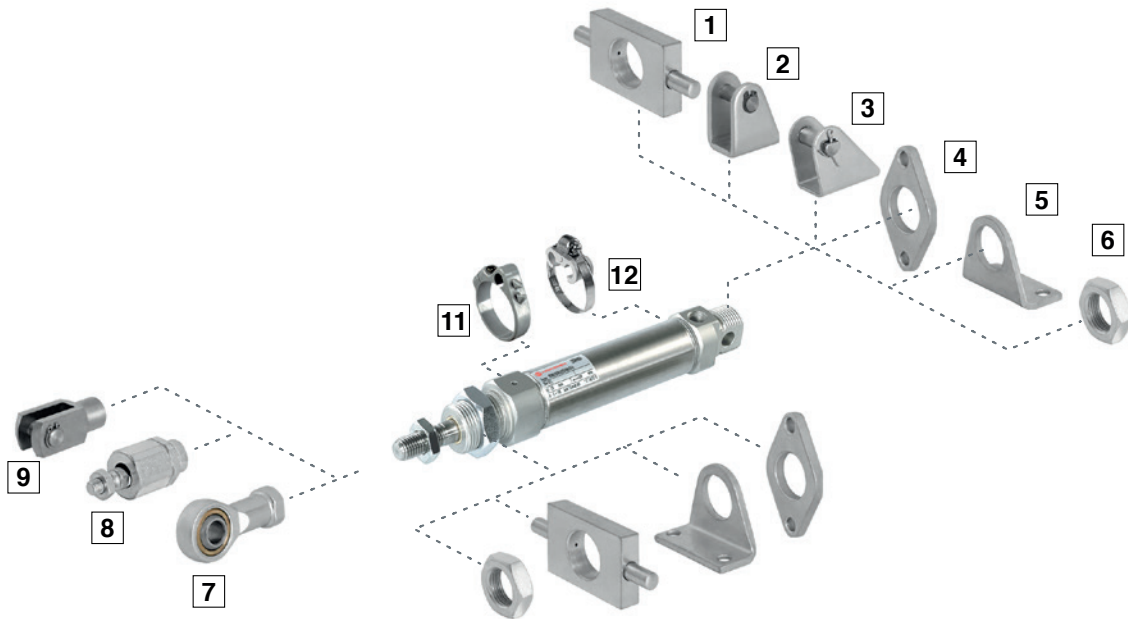



Substitute	Stroke (mm)	Substitute
10	max. 50	
12		
16		
20		
25		

Stroke (mm)	Substitute
max. 50	

Stroke (mm)	Substitute
max. 50	

Mountings and Accessories



Cyl.	AK	B, G	C	F	FH
					
	8	4	5	9	1
	Page 4	Page 4	Page 4	Page 4	Page 4
ø					
10	QM/8010/38	M/P19407	M/P19369	QM/8010/25	—
12	QM/8012/38	M/P19408	M/P19389	QM/8012/25	QM/8012/34
16	QM/8012/38	M/P19408	M/P19389	QM/8012/25	QM/8012/34
20	QM/8020/38	M/P19409	M/P19406	QM/8020/25	QM/8020/34
25	QM/8025/38	M/P19409	M/P19406	QM/8025/25	QM/8020/34
Cyl.	L	L2	N	UF	
					
	3	2	6	7	
	Page 4	Page 5	Page 5	Page 5	
ø					
10	QM/947	QM/8010/44	M/P1501/90	QM/8010/32	
12	QM/8012/24	QM/8012/44	M/P13834	QM/8012/32	
16	QM/8012/24	QM/8012/44	M/P13834	QM/8012/32	
20	QM/8020/24	QM/8020/44	M/P13615	QM/8020/32	
25	QM/8020/24	QM/8020/44	M/P13615	QM/8025/32	
Cyl.	Switch mounting brackets >15 mm stroke	<15 mm stroke	Magnetically operated switches		
					
	11	12	Page 6 & 7		
	Page 6	Page 6			
ø					
10	QM/33/012/22	QM/33/010/23			
12	QM/33/012/22	QM/33/016/23			
16	QM/33/016/22	QM/33/016/23			
20	QM/33/020/22	QM/33/020/23			
25	QM/33/025/22	QM/33/025/23			

**Basic dimensions
RM/28000/M**

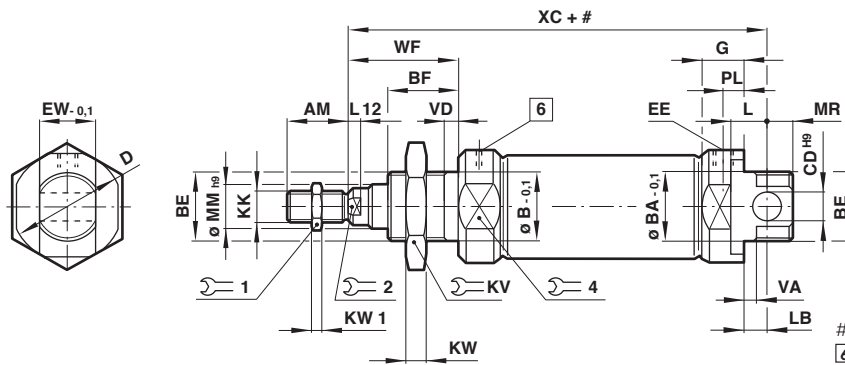
 Dimensions in mm
Projection/First angle

 # Stroke
 6 Exhaust position, do not obstruct

ø	AM	ø B/BA -0,1	BE	BF	ø CD H9	ø D	EE	EW -0,1	G	KK	KV	KW	KW1	L	Model
10	12	12	M12x1,25	12	4	16,5	M5	7,9	9	M4	19	6	2	6	RM/28010/M/*
12	16	16	M16x1,5	17	6	21	M5	11,9	9,5	M6	22	5	3	9	RM/28012/M/*
16	16	16	M16x1,5	17	6	21	M5	11,9	9,5	M6	22	5	3	9	RM/28016/M/*
20	20	22	M22x1,5	20	8	30	G1/8	15,9	15	M8	27	8	4	12	RM/28020/M/*
25	22	22	M22x1,5	22	8	30	G1/8	15,9	15	M10x1,25	27	8	5	12	RM/28025/M/*
ø	L12	LB	ø MM h9	MR	PL	1	2	4	WF	VA/VD	XC	at 0 mm per 25 mm		Model	
10	—	2	4	8	5,5	7	—	14	16	1,5	64	0,034 kg	0,007 kg	RM/28010/M/*	
12	3	3	6	8	5,5	10	5	19	22	2	75	0,058 kg	0,011 kg	RM/28012/M/*	
16	3	4	6	7	5,5	10	5	19	22	2	82	0,070 kg	0,012 kg	RM/28016/M/*	
20	3	3	8	11	8	13	7	27	24	2	95	0,145 kg	0,018 kg	RM/28020/M/*	
25	4	7	10	9	8	17	9	27	28	2	104	0,200 kg	0,028 kg	RM/28025/M/*	

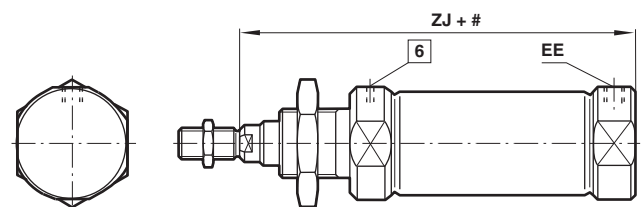
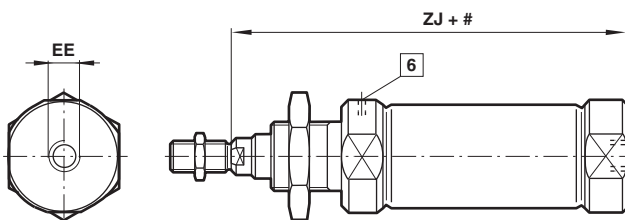
* Please insert standard stroke length.

**Alternative variants
RM/28000/MC –
Cylinder with central rear port**
**RM/28000/MF –
Cylinder with flat rear cover**

ø	EE	ZJ	at 0 mm	per 25 mm	Model
10	M5	62	0,031 kg	0,007 kg	RM/28010/M/*
12	M5	72	0,052 kg	0,011 kg	RM/28012/M/*
16	M5	78	0,064 kg	0,012 kg	RM/28016/M/*
20	G1/8	92	0,130 kg	0,018 kg	RM/28020/M/*
25	G1/8	97	0,185 kg	0,028 kg	RM/28025/M/*

 # Stroke
 6 Exhaust position, do not obstruct

* Please insert standard stroke length.

Mountings

Piston rod swivel AK

Conforms to DIN ISO 8139

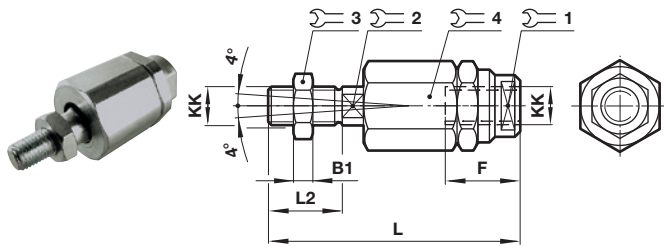

ø	KK	B1	F	L	L2	Screw positions				kg	Model (AK)
						1	2	3	4		
10	M 4	2	12,5	33	8	11	3,2	7	11	0,01	QM/8010/38
12/16	M 6	3	14	39	12	7	5	10	13	0,02	QM/8012/38
20	M 8	4	18	55	16	10	7	13	17	0,05	QM/8020/38
25	M 10 x 1,25	5	26	73	20	19	12	17	30	0,2	QM/8025/38

Front or rear flange G and B

Dimensions in mm
Projection/First angle

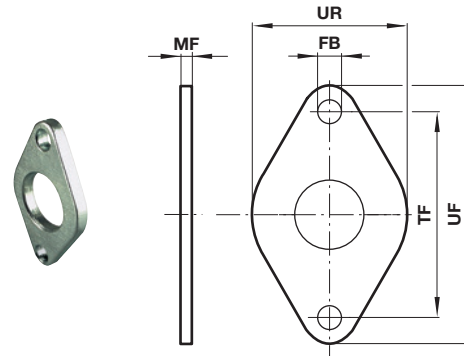

ø	ø FB	MF	TF	UF	UR	kg	Model (B, G)
10	4,5	3	30	40	22	0,02	M/P19407
12/16	5,5	4	40	51	28	0,03	M/P19408
20/25	6,6	5	50	63	38	0,05	M/P19409

Foot C

Conforms to DIN ISO 6432

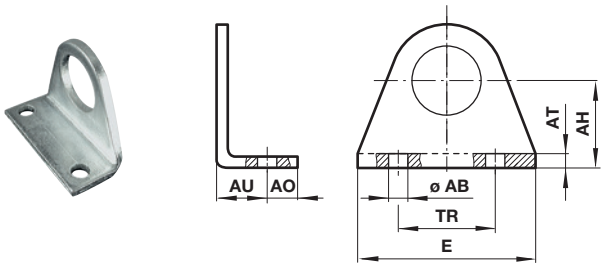

ø	ø AB	AH	AO	AT	AU	E	TR	kg	Model (C)
10	4,5	16	6	2	10	35	25	0,02	M/P19369
12/16	5,5	20	6	3	13	43	32	0,03	M/P19389
20/25	6,6	25	7,5	4	16	53	40	0,06	M/P19406

Piston rod clevis F

Conforms to DIN ISO 8140

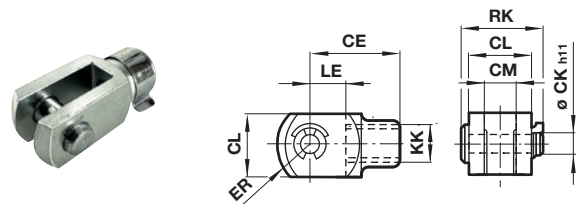

ø	KK	CE	ø CK h11	CL	CM	ER	LE	RK	kg	Model (F)
10	M 4	16	4	8	4	6,5	8	11,5	0,01	QM/8010/25
12/16	M 6	24	6	12	6	9,5	12	17,5	0,02	QM/8012/25
20	M 8	32	8	16	8	13	16	22	0,06	QM/8020/25
25	M 10 x 1,25	40	10	20	10	16	20	28	0,10	QM/8025/25

Front or rear detachable trunnion FH

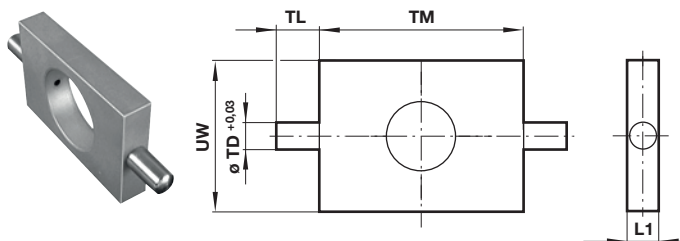

ø	L1	ø TD +0,03	TL	TM	UW	kg	Model (FH)
12/16	8	6	10	38	25	0,05	QM/8012/34
20/25	8	6	10	46	30	0,07	QM/8020/34

Rear hinge L

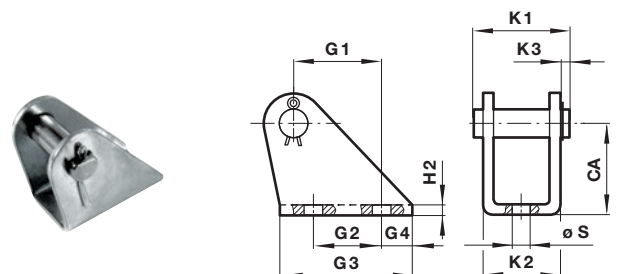

ø	CA	G1	G2	G3	G4	H2	K1	K2	K3	ø S	kg	Model (L)
10	12	6,5	-	15	6	1	13,5	10,5	2	4,8	0,01	QM/947
12/16	20	18,5	15	30	8	1,5	20	15	3	5,5	0,02	QM/8012/24
20/25	25	20	15	35	10	2	25	20,5	3	6,6	0,04	QM/8020/24

Rear hinge L2

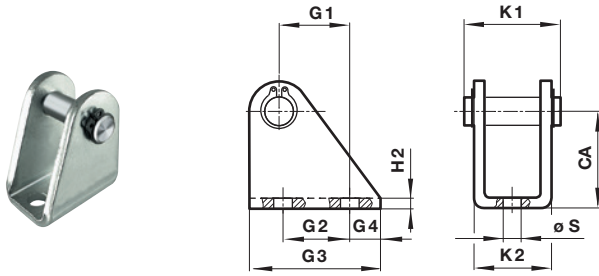

ø	CA	G1	G2	G3	G4	H2	K1	K2	ø S	kg	Model (L2)
10	24	11	12,5	20	4	2,5	17,5	13	4,5	0,018	QM/8010/44
12/16	27	13	15	25	5	3	23	18	5,5	0,035	QM/8012/44
20/25	30	16	20	32	6	4	29,5	24	6,6	0,077	QM/8020/44

Nose nut N

Dimensions in mm
Projection/First angle

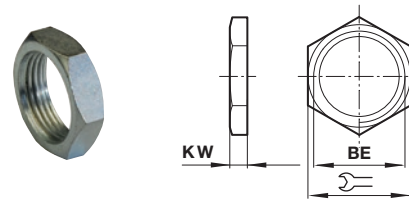

ø	BE	ø S	KW	kg	Model (N)
10	M12x1,25	19	6	0,01	M/P1501/90
12/16	M16x1,5	22	5	0,01	M/P13834
20/25	M22x1,5	27	8	0,02	M/P13615

Universal piston rod eye UF Conforms to DIN ISO 8139

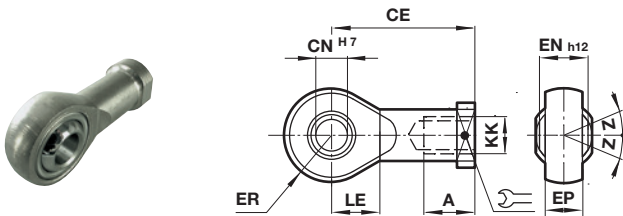

ø	KK	AX	CE	ø CN H7	EN -0,1	ER	LE	Z	kg	Model (UF)
10	M4	14	27	5	8	8	10	5°	0,02	QM/8010/32
12/16	M6	14	30	6	9	9	11	5°	0,02	QM/8012/32
20	M8	16	36	8	12	11	13	5°	0,05	QM/8020/32
25	M10 x 1,25	25	42	10	14	14	15	5°	0,08	QM/8025/32

Technical data - Reed switches - additional informations see data sheet N/en 4.3.005

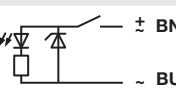
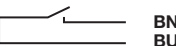
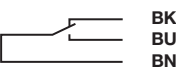
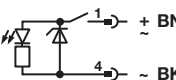
Symbol	Voltage (V a.c.) (V d.c.)	Current maximum (mA)	Function	Operating temperature (°C)	LED	Protection class	Plug	Cable length (m)	Cable type	Weight (g)	Model	
	10 ... 240	10 ... 170	180	Closer	-25 ... +80	•	IP66	—	2, 5 or 10	PVC 2 x 0,25	37	M/50/LSU/*V
	10 ... 240	10 ... 170	180	Closer	-25 ... +80	•	IP66	—	5	PUR 2 x 0,25	37	M/50/LSU/5U
	10 ... 240	10 ... 170	180	Closer	-25 ... +150	—	IP66	—	2	Silicon 2 x 0,25	37	TM/50/RAU/2S
	10 ... 240	10 ... 170	180	Changeover	-25 ... +80	—	IP66	—	5	PVC 3 x 0,25	37	M/50/RAC/5V
	10 ... 60	10 ... 60	180	Closer	-25 ... +80	•	IP66	M8 x 1	0,3	PVC 3 x 0,25	16	M/50/LSU/CP *1)

* Insert cable length; *1) Plug-in connector see page 11; Color code: BK = black, BN = brown, BU = blue

Drawings

M/50/LSU/*V, M/50/LSU/5U,
TM/50/RAU/2S
Cable length L = 2, 5 or 10 m

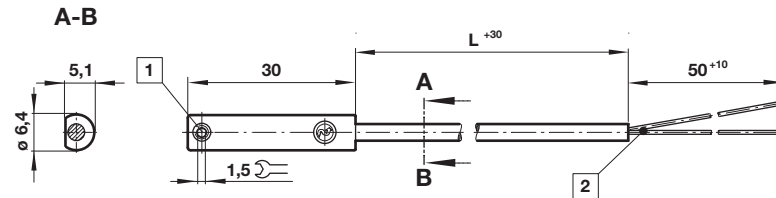

M/50/RAC/5V
Cable length L = 5 m

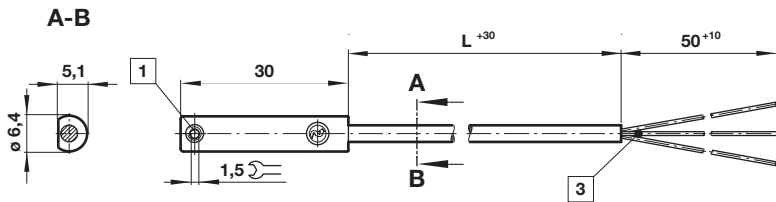

M/50/LSU/CP

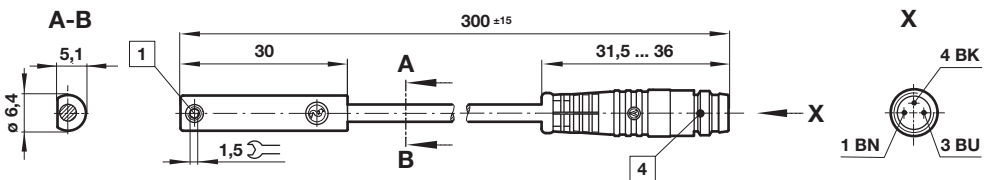

- 1 Fixing screw
- 2 + BN = brown; - BU = blue (output)
- 3 - BK = black; + BN = brown; - #BU = blue
- 4 Plug M8 x 1, color code: BK = black; BN = brown; BU = blue

Dimensions in mm
Projection/First angle

Switch mounting brackets - Brackets > 15 mm stroke

- 1 Magnetically operated switch
- 2 Switch mounting bracket

Switch mounting brackets - Brackets < 15 mm stroke

- 1 Magnetically operated switch
- 2 Switch mounting bracket

ø	B	R max.	kg	Model
10	8	16	0,01	QM/33/010/22
12	8	18	0,01	QM/33/012/22
16	10	20	0,01	QM/33/016/22
20	10	22	0,01	QM/33/020/22
25	10	24	0,01	QM/33/025/22

ø	S	T	kg	Model
10	27,5	19,5	0,01	QM/33/010/23
12	28,5	21,5	0,01	QM/33/016/23
16	29,5	23,5	0,01	QM/33/016/23
20	29,5	26	0,01	QM/33/020/23
25	31,5	28,5	0,01	QM/33/025/23

Technical data - Solid state - additional informations see data sheet N/en 4.3.007

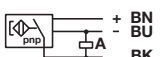
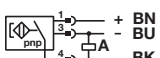
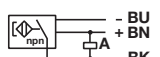
Symbol	Voltage (V d.c.)	Current maximum (mA)	Function	Operating temperature (°C)	LED	Protection class	Plug	Cable length (m)	Cable type	Weight (g)	Model
 + BN BU - BK	10 ... 30	150	PNP	-40 ... +80	•	IP67	—	2, 5 or 10	PVC 3 x 0,12	37	M/50/EAP/*V
	10 ... 30	150	PNP	-40 ... +80	•	IP68	—	5	PUR 3 x 0,14	37	M/50/EAP/5U
 + BN BU - BK	10 ... 30	150	PNP	-40 ... +80	•	IP67	M8 x 1	0,3	PVC 3 x 0,14	16	M/50/EAP/CP *1)
	10 ... 30	150	PNP	-40 ... +80	•	IP67	M12 x 1	0,3	PVC 3 x 0,14	16	M/50/EAP/CC *1)
 - BU BN + BK	10 ... 30	150	NPN	-40 ... +80	•	IP67	—	2, 5 or 10	PVC 3 x 0,12	37	M/50/EAN/*V
	10 ... 30	150	Closer	-40 ... +80	•	IP67	M8 x 1	0,3	PVC 3 x 0,14	16	M/50/EAN/CP *1)

* Insert cable length; *1) Plug-in connector below; Color code: BK = black, BN = brown, BU = blue

Drawings

M/50/EAP/*V,
M/50/EAN/*V
Cable length L = 2, 5 or 10 m

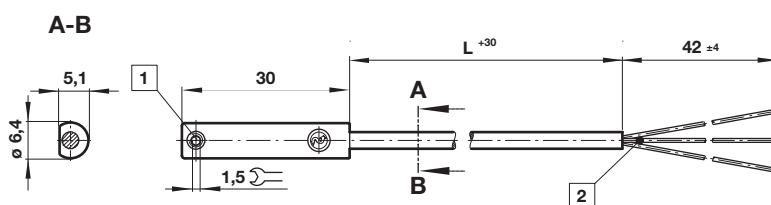

Dimensions in mm
Projection/First angle



M/50/EAP/CP,
M/50/EAN/CP

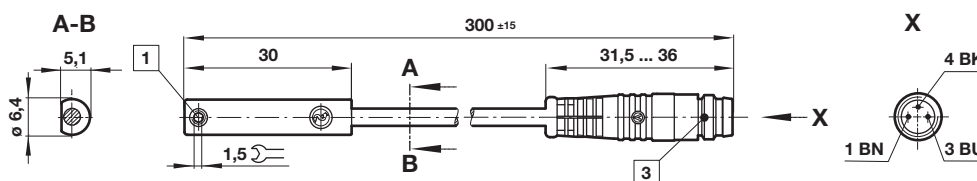

M/50/EAP/CC

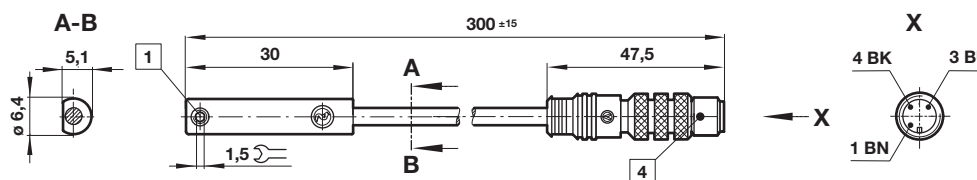

- 1 Fixing screw
- 2 Color code: BK = black; BN = brown; BU = blue
- 3 Plug M8 x 1
- 4 Plug M12 x 1

Accessories

Plug-in connector cable with nut



Outer cover	Cable length (m)	Weight (kg)	Connector	Connector
PVC 3 x 0,25	5 m	0,18	M8 x 1	M/P73001/5
PUR 3 x 0,25	5 m	0,18	M8 x 1	M/P73002/5
PUR 3 x 0,34	5 m	0,21	M12 x 1	M/P34594/5

Warning

These products are intended for use in industrial compressed air systems only. Do not use these products where pressures and temperatures can exceed those listed under »Technical features/ data«.

Before using these products with fluids other than those specified, for non-industrial applications, life-support systems or other applications not within published specifications, consult IMI Precision Engineering.

Through misuse, age, or malfunction, components used in fluid power systems can fail in various modes.

The system designer is warned to consider the failure modes of all component parts used in fluid power systems and to provide adequate safeguards to prevent personal injury or damage to equipment in the event of such failure.

System designers must provide a warning to end users in the system instructional manual if protection against a failure mode cannot be adequately provided.

System designers and end users are cautioned to review specific warnings found in instruction sheets packed and shipped with these products.