

Power supply unit - QUINT-PS/1AC/24DC/20



2866776

<https://www.phoenixcontact.com/us/products/2866776>

Please be informed that the data shown in this PDF document is generated from our Online Catalog. Please find the complete data in the user documentation. Our General Terms of Use for Downloads are valid.



Primary-switched power supply unit, QUINT POWER, Screw connection, DIN rail mounting, SFB Technology (Selective Fuse Breaking), input: 1-phase, output: 24 V DC / 20 A

Product Description

QUINT POWER power supplies with maximum functionality

QUINT POWER circuit breakers magnetically and therefore quickly trip at six times the nominal current, for selective and therefore cost-effective system protection. The high level of system availability is additionally ensured, thanks to preventive function monitoring, as it reports critical operating states before errors occur.

Reliable starting of heavy loads takes place via the static power reserve POWER BOOST. Thanks to the adjustable voltage, all ranges between 5 V DC ... 56 V DC are covered.

Your advantages

- Reliable starting of difficult loads with the static POWER BOOST power reserve with up to 1.5 times the nominal current permanently
- Fast tripping of standard circuit breakers with dynamic power reserve SFB (selective fuse breaking) technology with up to 6 times the nominal current for 12 ms
- For superior system availability
- Preventive function monitoring

Commercial Data

Item number	2866776
Packing unit	1 pc
Minimum order quantity	1 pc
Sales Key	C14
Product Key	CMPQ13
Catalog Page	Page 159 (C-6-2015)
GTIN	4046356113557
Weight per Piece (including packing)	2,103 g
Weight per Piece (excluding packing)	1,608 g
Customs tariff number	85044030
Country of origin	TH

Technical Data

Input data

AC operation

Nominal input voltage range	100 V AC ... 240 V AC
Input voltage range	100 V AC ... 240 V AC -15 % ... +10 %
Input voltage range AC	85 V AC ... 264 V AC
Input voltage range DC	90 V DC ... 350 V DC
Electric strength, max.	300 V AC
Typical national grid voltage	120 V AC
	230 V AC
Voltage type of supply voltage	AC
Inrush current	< 20 A
Inrush current integral (I^2t)	< 3.2 A ² s
Inrush current limitation	20 A
AC frequency range	45 Hz ... 65 Hz
Frequency range DC	0 Hz
Mains buffering time	> 32 ms (120 V AC)
	> 32 ms (230 V AC)
Current consumption	5.1 A (100 V AC)
	5.1 A (120 V AC)
	2.3 A (230 V AC)
	2.3 A (240 V AC)
Nominal power consumption	569 VA
Protective circuit	Transient surge protection; Varistor
Power factor (cos phi)	0.89
Typical response time	< 0.6 s
Input fuse	12 A (slow-blow, internal)
Permissible backup fuse	B10 B16 AC:
Permissible DC backup fuse	DC: Connect a suitable fuse upstream
Recommended breaker for input protection	10 A ... 16 A (Characteristic B, C)
Discharge current to PE	< 3.5 mA

DC operation

Nominal input voltage range	110 V DC ... 250 V DC
Input voltage range	110 V DC ... 250 V DC -18 % ... +40 %
Current consumption	4.9 A (110 V DC)
	2.4 A (220 V DC)
Recommended breaker for input protection	10 A (Connect suitable fuse upstream)

Output data

Efficiency	typ. 92 % (120 V AC)
	typ. 92.7 % (230 V AC)

Power supply unit - QUINT-PS/1AC/24DC/20



2866776

<https://www.phoenixcontact.com/us/products/2866776>

Output characteristic	U/I
Nominal output voltage	24 V DC ± 1 %
Setting range of the output voltage (U_{Set})	18 V DC ... 29.5 V DC (> 24 V DC, constant capacity restricted)
Nominal output current (I_N)	20 A
POWER BOOST (I_{Boost})	26 A (-25 °C ... 40 °C permanent, $U_{OUT} = 24$ V DC)
Static Boost ($I_{Stat.Boost}$)	26 A ($U_{In} \geq 100$ V AC, ≥ 110 V DC)
Selective Fuse Breaking (I_{SFB})	120 A (12 ms)
Magnetic circuit breaker tripping	B2 / B4 / B6 / B10 / B16 / C2 / C4 / C6
Derating	60 °C ... 70 °C (2.5%/K)
Feedback voltage resistance	≤ 35 V DC
Protection against overvoltage at the output (OVP)	≤ 35 V DC
Control deviation	< 1 % (change in load, static 10 % ... 90 %) < 2 % (change in load, dynamic 10 % ... 90 %) < 0.1 % (change in input voltage ± 10 %)
Residual ripple	< 30 mV _{PP} (with nominal values)
Short-circuit-proof	yes
Output power	480 W 624 W
Maximum no-load power dissipation	8 W
Power loss nominal load max.	40 W
Rise time	< 0.1 s (U_{OUT} (10 % ... 90 %))
Connection in parallel	yes, for redundancy and increased capacity
Connection in series	yes

Signal: DC OK active

Output description	$U_{OUT} > 0.9 \times U_N$: High signal
Switching voltage range	18 V DC ... 24 V DC
Maximum inrush current	≤ 20 mA (short-circuit-proof)
Continuous load current	≤ 20 mA

Signal: DC OK floating

Output description	Relay contact, $U_{OUT} > 0.9 \times U_N$: Contact closed
Maximum switching voltage	30 V AC 24 V DC
Maximum inrush current	0.5 A 1 A
Continuous load current	≤ 1 A

Signal: POWER BOOST, active

Output description	$I_{OUT} < I_N$: High signal
Switching voltage range	18 V DC ... 24 V DC
Output voltage	+ 24 V DC
Maximum inrush current	20 mA (short-circuit-proof)
Continuous load current	≤ 20 mA

Power supply unit - QUINT-PS/1AC/24DC/20



2866776

<https://www.phoenixcontact.com/us/products/2866776>

Connection data

Input

Connection method	Screw connection
Conductor cross section solid min.	0.2 mm ²
Conductor cross section solid max.	6 mm ²
Conductor cross section flexible min.	0.2 mm ²
Conductor cross section flexible max.	4 mm ²
Conductor cross section AWG min.	18
Conductor cross section AWG max.	10
Stripping length	7 mm
Screw thread	M4
Tightening torque, min	0.5 Nm
Tightening torque max	0.6 Nm

Output

Connection method	Screw connection
Conductor cross section solid min.	0.2 mm ²
Conductor cross section solid max.	6 mm ²
Conductor cross section flexible min.	0.2 mm ²
Conductor cross section flexible max.	4 mm ²
Conductor cross section AWG min.	12
Conductor cross section AWG max.	10
Stripping length	7 mm
Screw thread	M4
Tightening torque, min	0.5 Nm
Tightening torque max	0.6 Nm

Signal

Connection method	Screw connection
Conductor cross section solid min.	0.2 mm ²
Conductor cross section solid max.	6 mm ²
Conductor cross section flexible min.	0.2 mm ²
Conductor cross section flexible max.	4 mm ²
Conductor cross section AWG min.	18
Conductor cross section AWG max.	10
Screw thread	M4
Tightening torque, min	0.5 Nm
Tightening torque max	0.6 Nm

LED signaling

Types of signaling	LED
	Active switching output
	Relay contact

Power supply unit - QUINT-PS/1AC/24DC/20



2866776

<https://www.phoenixcontact.com/us/products/2866776>

Signal output: DC OK active

Status display	$U_{OUT} > 0.9 \times U_N$: "DC OK" LED green
Note on status display	$U_{OUT} < 0.9 \times U_N$: Flashing "DC OK" LED
	$I_{OUT} < I_N$: LED ON

Signal output: DC OK floating

Status display	$U_{OUT} > 0.9 \times U_N$: "DC OK" LED green
Note on status display	$U_{OUT} < 0.9 \times U_N$: Flashing "DC OK" LED

Signal output: POWER BOOST, active

Status display	$I_{OUT} > I_N$: LED "BOOST" yellow
----------------	--------------------------------------

Electrical properties

Number of phases	1.00
Insulation voltage input/output	4 kV AC (type test)
	2 kV AC (routine test)
Insulation voltage output / PE	500 V DC (routine test)
Insulation voltage input / PE	3.5 kV AC (type test)
	2 kV AC (routine test)

Product properties

Product type	Power supply
MTBF (IEC 61709, SN 29500)	> 900000 h (25 °C)
	> 520000 h (40 °C)
	> 235000 h (60 °C)

Insulation characteristics

Protection class	I
Degree of pollution	2

Dimensions

Width	90 mm
Height	130 mm
Depth	125 mm

Installation dimensions

Installation distance right/left	5 mm / 5 mm
Installation distance top/bottom	50 mm / 50 mm

Alternative assembly

Width	122 mm
Height	130 mm
Depth	93 mm

Mounting

Mounting type	DIN rail mounting
---------------	-------------------

Power supply unit - QUINT-PS/1AC/24DC/20



2866776

<https://www.phoenixcontact.com/us/products/2866776>

Assembly instructions	alignable: $P_N \geq 50\%$, 5 mm horizontally, 15 mm next to active components, 50 mm vertically alignable: $P_N < 50\%$, 0 mm horizontally, 40 mm vertically top, 20 mm vertically bottom
Mounting position	horizontal DIN rail NS 35, EN 60715
With protective coating	No

Material specifications

Housing material	Metal
Hood version	Galvanized sheet steel, free from chrome (VI)
Side element version	Aluminum

Environmental and real-life conditions

Ambient conditions

Degree of protection	IP20
Ambient temperature (operation)	-25 °C ... 70 °C (> 60 °C Derating: 2,5 %/K)
Ambient temperature (storage/transport)	-40 °C ... 85 °C
Ambient temperature (start-up type tested)	-40 °C
Maximum altitude	≤ 5000 m (> 2000 m, observe derating)
Climatic class	3K22 (in accordance with EN 60721-3-3)
Max. permissible relative humidity (operation)	≤ 95 % (at 25 °C, non-condensing)
Shock	18 ms, 30g, in each space direction (according to IEC 60068-2-27)
Vibration (operation)	< 15 Hz, amplitude ±2.5 mm (according to IEC 60068-2-6) 15 Hz ... 150 Hz, 2.3g, 90 min.

Standards and regulations

Rail applications	EN 50121-4 EN 50121-3-2
HART FSK Physical Layer Test Specification Compliance	Output voltage U_{Out} compliant
Standard – Limitation of mains harmonic currents	EN 61000-3-2
Standard - Electrical safety	IEC 61010-2-201 (SELV)
Standard - Equipment safety	BG (design tested)
Standard - Approval for medical use	IEC 60601-1, 2 x MOOP
Standard – Safety extra-low voltage	IEC 61010-1 (SELV) IEC 61010-2-201 (PELV)
Standard - Safe isolation	IEC 61010-2-201
Standard - safety for equipment for measurement, control, and laboratory use	IEC 61010-1
Approval - requirement of the semiconductor industry with regard to mains voltage dips	SEMI F47-0706 Compliance Certificate

Overvoltage category

EN 61010-1	II (≤ 5000 m)
EN 62477-1	III (≤ 2000 m)

Approval data

CSA	CAN/CSA-C22.2 No. 60950-1-07
	CSA-C22.2 No. 107.1-01
Shipbuilding approval	DNV GL (EMC B, only with upstream filter), ABS, LR, RINA, NK, BV
SIQ	BG (type approved)
UL approvals	UL Listed UL 508
	UL/C-UL Recognized UL 60950-1
	UL ANSI/ISA-12.12.01 Class I, Division 2, Groups A, B, C, D (Hazardous Location)

EMC data

Low Voltage Directive	Conformance with Low Voltage Directive 2014/35/EC
Electromagnetic compatibility	Conformance with EMC Directive 2014/30/EU
EMC requirements for noise emission	EN 61000-6-3
	EN 61000-6-4
EMC requirements for noise immunity	EN 61000-6-1
	EN 61000-6-2
Noise emission	EN 55011 (EN 55022)
Noise immunity	EN 61000-6-2

Electrostatic discharge

Standards/regulations	EN 61000-4-2
-----------------------	--------------

Electrostatic discharge

Contact discharge	8 kV (Test Level 4)
Discharge in air	15 kV (Test Level 4)
Comments	Criterion A

Electromagnetic HF field

Standards/regulations	EN 61000-4-3
-----------------------	--------------

Electromagnetic HF field

Frequency range	80 MHz ... 1 GHz
Test field strength	20 V/m (Test Level 3)
Frequency range	1 GHz ... 2 GHz
Test field strength	10 V/m (Test Level 3)
Frequency range	2 GHz ... 3 GHz
Test field strength	10 V/m (Test Level 3)
Comments	Criterion A

Fast transients (burst)

Standards/regulations	EN 61000-4-4
-----------------------	--------------

Fast transients (burst)

Input	4 kV (Test Level 4 - asymmetrical)
Output	2 kV (Test Level 3 - asymmetrical)

Power supply unit - QUINT-PS/1AC/24DC/20



2866776

<https://www.phoenixcontact.com/us/products/2866776>

Signal	2 kV (Test Level 4 - asymmetrical)
Comments	Criterion A

Surge voltage load (surge)

Standards/regulations	EN 61000-4-5
Input	2 kV (Test Level 3 - symmetrical)
	4 kV (Test Level 4 - asymmetrical)
Output	1 kV (Test Level 2 - symmetrical)
	2 kV (Test Level 3 - asymmetrical)
Signal	1 kV (Test Level 2 - asymmetrical)
Comments	Criterion A

Conducted interference

Standards/regulations	EN 61000-4-6
-----------------------	--------------

Conducted interference

I/O/S	asymmetrical
Frequency range	0.15 MHz ... 80 MHz
Comments	Criterion A
Voltage	10 V (Test Level 3)

Emitted interference

Standards/regulations	EN 61000-6-3
Radio interference voltage in acc. with EN 55011	EN 55011 (EN 55022) Class B, area of application: Industry and residential
Emitted radio interference in acc. with EN 55011	EN 55011 (EN 55022) Class B, area of application: Industry and residential
Criterion A	Normal operating behavior within the specified limits.
Criterion B	Temporary impairment to operational behavior that is corrected by the device itself.

Power supply unit - QUINT-PS/1AC/24DC/20



2866776

<https://www.phoenixcontact.com/us/products/2866776>

Drawings

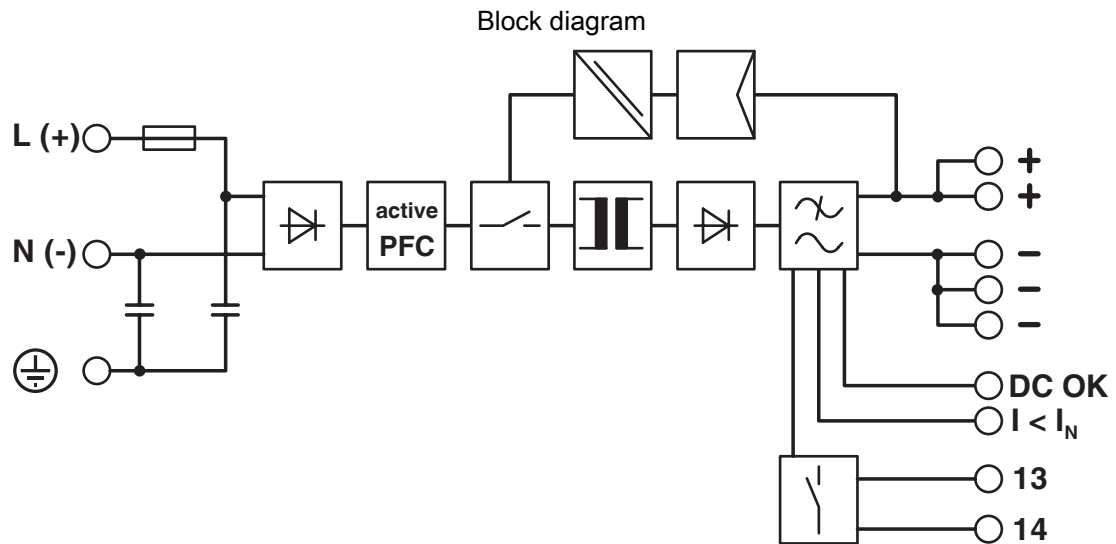

Block diagram

Power supply unit - QUINT-PS/1AC/24DC/20



2866776

<https://www.phoenixcontact.com/us/products/2866776>

Approvals

 **CSA**
Approval ID: 1897790

 **cUL Recognized**
Approval ID: FILE E 211944

 **UL Recognized**
Approval ID: FILE E 211944

 **IECEE CB Scheme**
Approval ID: SI-2793

 **EAC**
Approval ID: EAC-Zulassung

 **DNV GL**
Approval ID: TAA000030X

 **LR**
Approval ID: LR22301698TA

 **ClassNK** **NK**
Approval ID: TA22564M

 **BV**
Approval ID: 21004-C0 BV

 **EAC**
Approval ID: EAC-Zulassung

 **UL Listed**
Approval ID: FILE E 123528

BSH
Approval ID: Nr. 581