

Product data sheet

Specifications

SQUARE D

Green Premium™



Mini circuit breaker, QO, 20A, 1 pole, 120/240VAC, 10kA, plug in mount

QO120

Product availability : Stock - Normally stocked in distribution facility

Price* : 29.10 USD

Main

Product	Miniature circuit-breaker
Range	QO
Current Rating	20 A
Voltage Rating	120/240 V AC 120 V AC 48 V DC
Mounting Type	Plug-in
Number of Poles	1P
Circuit Breaker Type	Standard
Ratings	HACR and Switching Duty rated
Electrical Connection	Pressure plate

Complementary

Interrupt Rating	10 kA 120/240 V AC 50/60 Hz 10 kA 120 V AC 50/60 Hz 5 kA 48 V DC
Number of Panel Spaces	1
Wire Size	AWG 14...AWG 8 copper or aluminium
Tightening Torque	44.25 lbf.in (5 N.m) 0.02...0.04 in ² (10...25 mm ²) (AWG 8...AWG 2)
Height	2.99 in (76 mm)
Width	0.75 in (19 mm)
Depth	2.91 in (74 mm)
Net weight	0.25 lb(US) (0.113 kg)

Environment

Certifications	UL Listed CSA
Ambient Rating	104 °F (40 °C)

Ordering and shipping details

Category	37539-QO BKRS
Discount Schedule	SLCB

* Price is "List Price" and may be subject to a trade discount – check with your local distributor or retailer for actual price.

GTIN	785901400103
Nbr. of units in pkg.	1
Package weight(Lbs)	4.00 oz (113.398 g)
Returnability	Yes
Country of origin	US

Packing Units

Unit Type of Package 1	PCE
Package 1 Height	0.80 in (2.032 cm)
Package 1 width	3.00 in (7.62 cm)
Package 1 Length	3.30 in (8.382 cm)
Unit Type of Package 2	BB1
Number of Units in Package 2	10
Package 2 Weight	2.83 lb(US) (1.284 kg)
Package 2 Height	3.10 in (7.874 cm)
Package 2 width	3.00 in (7.62 cm)
Package 2 Length	7.70 in (19.558 cm)
Unit Type of Package 3	CAR
Number of Units in Package 3	100
Package 3 Weight	28.60 lb(US) (12.973 kg)
Package 3 Height	8.50 in (21.59 cm)
Package 3 width	7.20 in (18.288 cm)
Package 3 Length	17.40 in (44.196 cm)

Offer Sustainability

Sustainable offer status	Green Premium product
REACH Regulation	REACH Declaration
REACH free of SVHC	Yes
EU RoHS Directive	Compliant EU RoHS Declaration
Toxic heavy metal free	Yes
Mercury free	Yes
RoHS exemption information	Yes
China RoHS Regulation	China RoHS declaration Pro-active China RoHS declaration (out of China RoHS legal scope)
Halogen content performance	Halogen free product

Contractual warranty

Warranty	18 months
----------	-----------

Dimensions

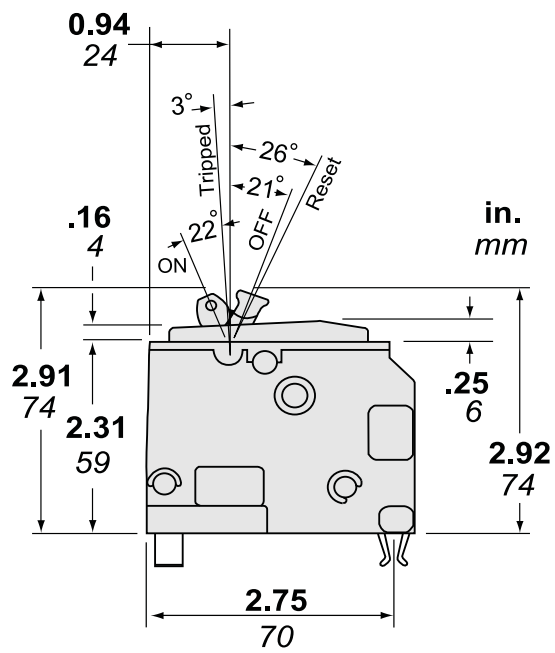
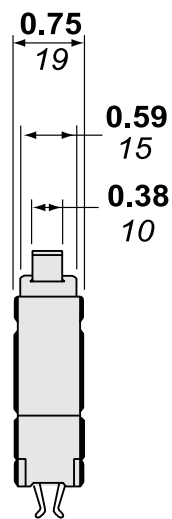
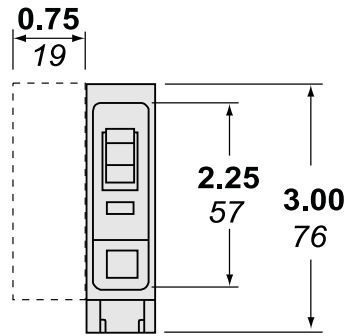

Dimensions are approximate. Refer to technical documentation for additional detail.