

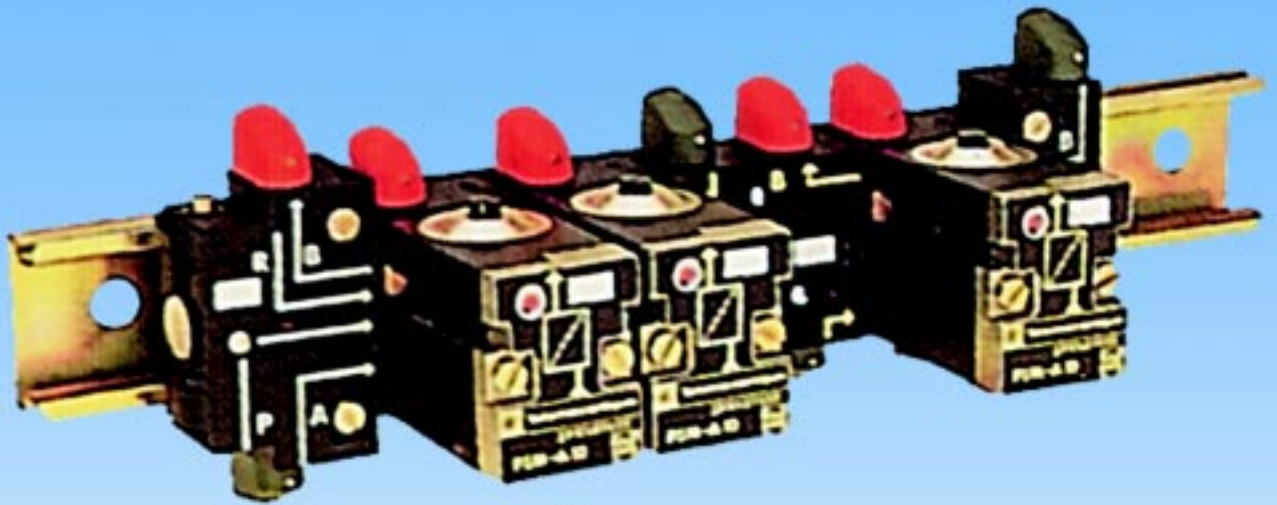





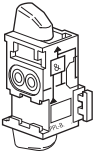

# Logic Processing

*Modular sequencer, inline/modular  
logic elements, bus mounted elements,  
relays, electrical operators,  
impulse-counters, timers*

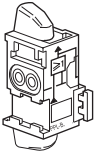

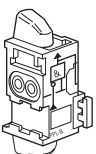

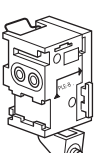



Catalogue No.: PDOC 00029UK01ev

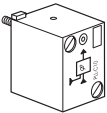

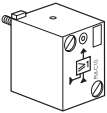
## Main data for Combinable elements

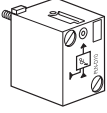
Type	Symbol	Logic function	Description	Connection*	Weight Kg	Order code	D
		AND	With built-in key for combination and operating mode selection	Ø4mm Swivel push-in	0,08	<b>PLL-B12</b>	1
		OR	With built-in key for combination and operating mode selection	Ø4mm Swivel push-in	0,08	<b>PLK-B12</b>	1
		NOT	With built-in key for combination and operating mode selection	Ø4mm Swivel push-in	0,08	<b>PLN-B12</b>	1
		INPUT	With built-in key for combination, clip for mounting on DIN rail and blankingplate for closing a bank of combined elements	Ø4mm swivel push-in	0,08	<b>PLE-B12</b>	1

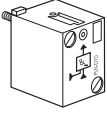
## Main data for Subbase mounted elements

Type	Symbol	Logic function	Description	Connection*	Weight Kg	Order code	D
(For use with 3 port subbase, type PZU•• please see page 3-4)							
		AND	With visual indication of pneumatic output signal		0,03	<b>PLL-C10</b>	1
		OR	With visual indication of pneumatic output signal		0,03	<b>PLK-C10</b>	1
		NOT inhibit standard	With visual indication of pneumatic input/output signal		0,03	<b>PLN-C10</b>	1
		NOT inhibit threshold	With visual indication of pneumatic input/output signal		0,03	<b>PLN-D10</b>	1

\* For other type of connections contact Technical Sales Department

# Logic Processing

## Dimensions, Logic processing

### Modular sequencer

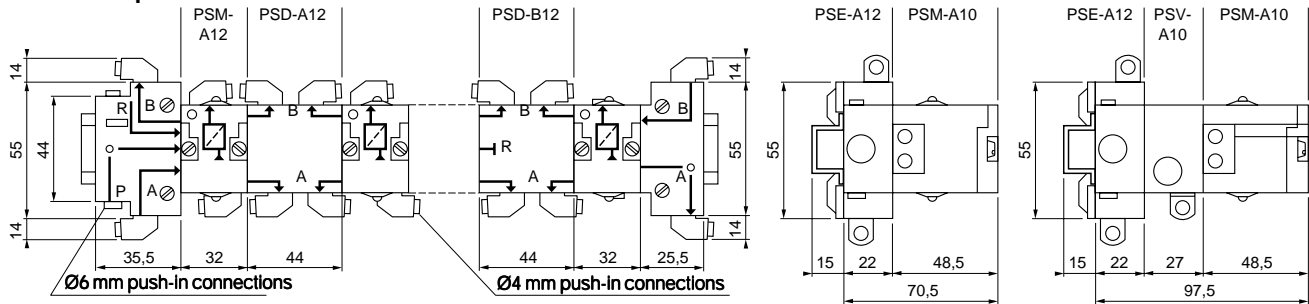

### Line mounted logic elements

PLL-A11 and PLK-A11

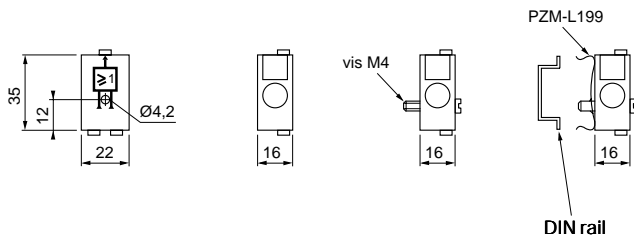

### Combinable logic elements

PLE-B12 — PLL-B12 — PLK-B12 and PLN-B12

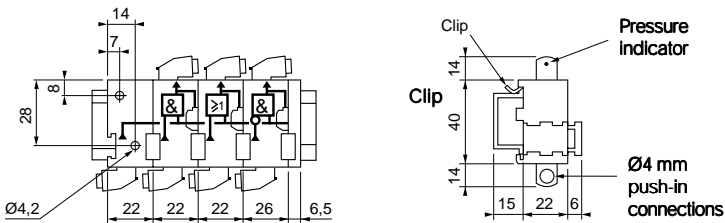

### Logic elements mounted on 3-port modular subbases

PZU-E12

PLJ-C10 — PLN-C10 — PLK-C10 and PLL-C10 mounted on PZU-C12 and PZU-A12

