

Inductive sensor

NBB15-U1K-N0

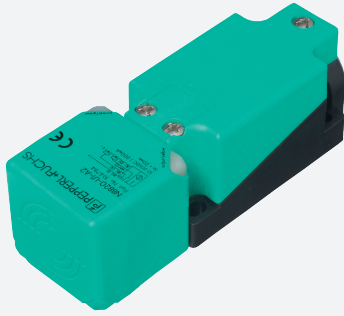

- Sensor head bidirectional and rotatable
- 15 mm flush



Dimensions

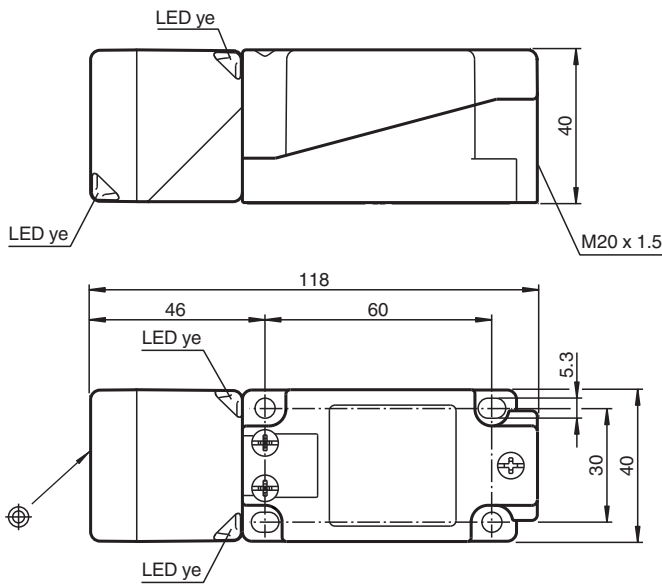

Technical Data

General specifications

Switching function		Normally closed (NC)
Output type		NAMUR
Rated operating distance	s_n	15 mm
Installation		flush
Assured operating distance	s_a	0 ... 12.15 mm
Actual operating distance	s_r	13.5 ... 16.5 mm typ.
Reduction factor r_{Al}		0.33
Reduction factor r_{Cu}		0.28
Reduction factor r_{304}		0.74

Release date: 2021-08-05 Date of issue: 2021-08-05 Filename: 70133098_eng.pdf

Refer to "General Notes Relating to Pepperl+Fuchs Product Information".

Pepperl+Fuchs Group
www.pepperl-fuchs.com

USA: +1 330 486 0001
fa-info@us.pepperl-fuchs.com

Germany: +49 621 776 1111
fa-info@de.pepperl-fuchs.com

Singapore: +65 6779 9091
fa-info@sg.pepperl-fuchs.com

PF PEPPERL+FUCHS

Technical Data

Output type		2-wire
Nominal ratings		
Nominal voltage	U _o	8.2 V (R _i approx. 1 kΩ)
Switching frequency	f	0 ... 400 Hz
Hysteresis	H	1 ... 15 typ. 5 %
Reverse polarity protection		reverse polarity protected
Short-circuit protection		yes
Current consumption		
Measuring plate not detected		min. 3 mA
Measuring plate detected		≤ 1 mA
Switching state indicator		LED, yellow
Functional safety related parameters		
MTTF _d		1660 a
Mission Time (T _M)		20 a
Diagnostic Coverage (DC)		0 %
Compliance with standards and directives		
Standard conformity		
NAMUR		EN 60947-5-6:2000 IEC 60947-5-6:1999
Electromagnetic compatibility		NE 21:2007
Standards		EN 60947-5-2:2007 EN 60947-5-2/A1:2012 IEC 60947-5-2:2007 IEC 60947-5-2 AMD 1:2012
Approvals and certificates		
IECEX approval		
Equipment protection level Ga		IECEX PTB 11.0021X
Equipment protection level Gb		IECEX PTB 11.0021X
Equipment protection level Da		IECEX PTB 11.0021X
Equipment protection level Mb		IECEX PTB 11.0021X
ATEX approval		
Equipment protection level Ga		PTB 00 ATEX 2032 X
Equipment protection level Gb		PTB 00 ATEX 2032 X
Equipment protection level Da		PTB 00 ATEX 2032 X
UL approval		
Ordinary Location		E87056
Hazardous Location		E501628
Control drawing		116-0451
CCC approval		
Hazardous Location		2020322315002303
NEPSI approval		
NEPSI certificate		GYJ16.1394X
ANZEX		19.3001X
Marine approval		DNVGL TAA00001A5
Ambient conditions		
Ambient temperature		-25 ... 100 °C (-13 ... 212 °F)
Storage temperature		-40 ... 100 °C (-40 ... 212 °F)
Mechanical specifications		
Connection type		screw terminals
Information for connection		A maximum of two conductors with the same core cross section may be mounted on one terminal connection! tightening torque 1.2 Nm + 10 %
Core cross-section		up to 2.5 mm ² , stripped insulation length: 7 mm
Minimum core cross-section		without wire end ferrule 0.5 mm ² , with connector sleeves 0.34 mm ²
Maximum core cross-section		without wire end ferrule 2.5 mm ² , with connector sleeves 1.5 mm ²

Release date: 2021-08-05 Date of issue: 2021-08-05 Filename: 70133098_eng.pdf



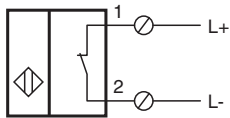

Technical Data

Connection (system side)	screw terminals , M20 x 1.5 cable gland , usable thread length 9.1 mm , screw-in depth max. 9.1 mm
Housing material	PA
Sensing face	PA
Degree of protection	IP66 / IP68 / IP69K
Mass	225 g
Note	Tightening torque: 1.8 Nm (housing)
General information	
Use in the hazardous area	see instruction manuals

Connection



Accessories

	MHW 01	Modular mounting bracket
	MH 04-2057B	Mounting aid for VariKont and +U1+
	KCD2-SR-Ex1.LB	
	KCD2-E2L	Sensor output interface terminal with lead breakage monitoring