

LR-power relay

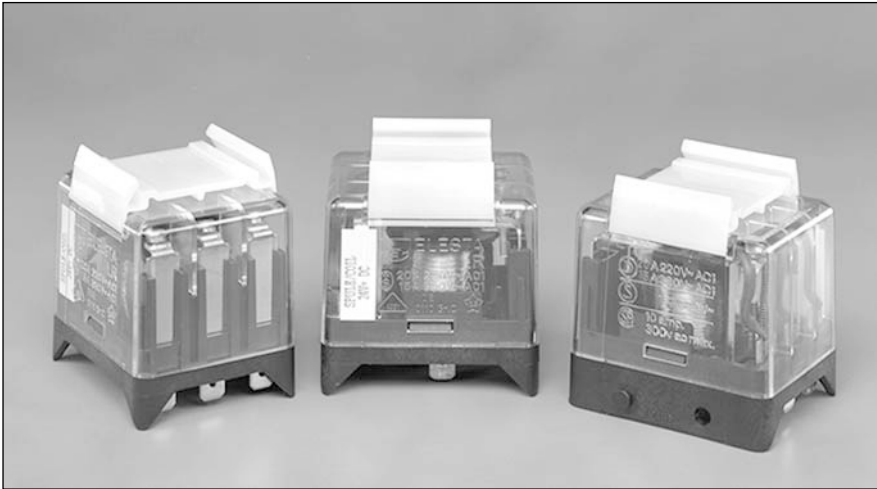

the power relay LR

LR relays are power relays which convince by her brilliant simplicity. The mature and simple construction will predestine this relay for the rough and uncompromising use.

By using best materials and because of the simple construction a max. mechanical and electrical life time was achieved.

The special advantages of this mature relay lie in the high switching power as well as in the low power consumption of the coil.

The LR relay is available in AC- and also in DC- version

features

- simple construction
- high switching power
- low coil power
- extraordinary life time
- DIN rail mountable

applications

- switching of short-circuit runner engines
- radiators in household appliance
- radiators in electromechanical ovens

type number key

LR 024 VDC

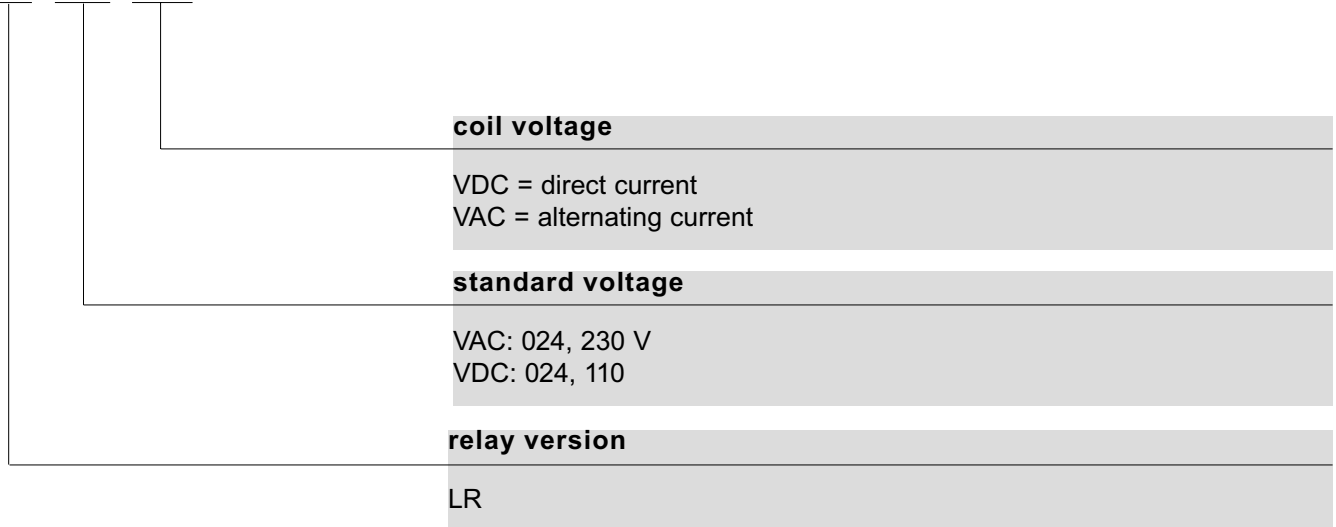

order sample

LR 230 VAC

- 3 normally open contacts
- coil voltage 230 VAC
- AMP connections
- DIN-rail installation

LR - power relay

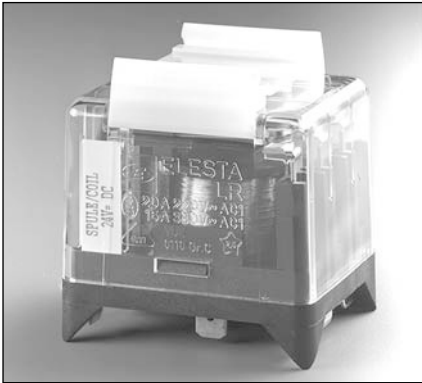

Power relays especially for switching high AC- loads.

order numbers

serial version	LR 220 VAC LR 24 VDC
----------------	-------------------------

contact specifications

(see data sheet for curves)

contact material	AgCdO
contact type	single contact
nominal switching capacity	250 VAC 20A AC1 5000 VA 400 VAC 15A AC1
electric life expectancy	app. 900'000 operations 250 VAC 20A AC1 (360 Schaltung/h)
inrush current max.	50A for 200 ms
switching current range	500mA to 20A
switching power range	8VA(W) to 5000VA

general data

max. switching frequency mechanical	15
mechanic life expectancy	20 Mio.
pull-in time	13 ms (VDC) /6-14 ms (VAC)
release time	2,5 ms (VDC) /3-12 ms (VAC)
bounce time	2 ms (VDC) /3 - 8 ms (VAC)
shock resistance	AK: 10 g
test voltage, coil/contact	2'500 V _{eff}
test voltage, open contact	2'500 V _{eff}
insulation resistance	>10 ¹² Ohm
weight	120 g
installation situation	any
ambient temperature max.	+60 °C

tests, instructions

certificates	CSA, VDE
insulation group	VDE 0110 / group C 250 VAC

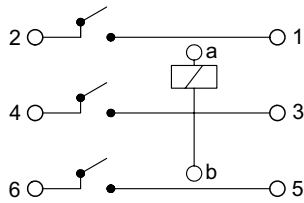
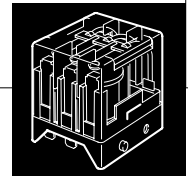

circuit diagram

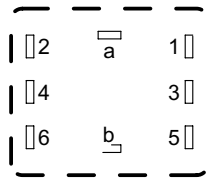

AMP connection side

dimensions

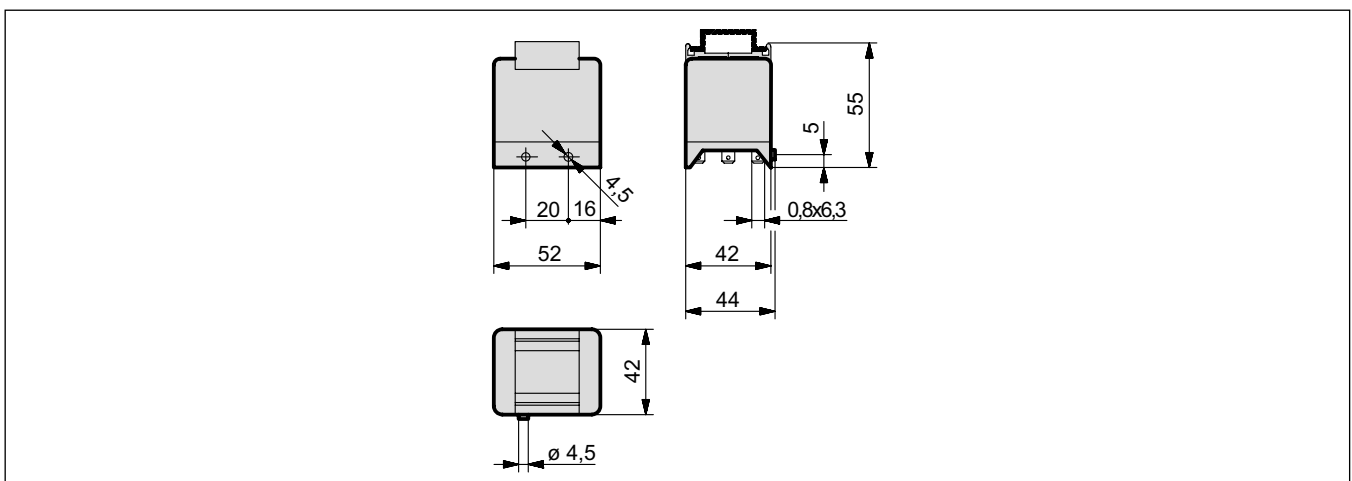

coil specifications

standard coils for direct current (other voltages on enquiry)

rated voltage VDC	pull-in voltage at 20 °C	reset voltage at 20 °C	nominal current mA	resistance Ohm at 20 °C	tolerance %
12	9	≥ 0,6	114	105	+/-10
24	18	≥ 1,2	58,5	410	+/-10
48	36	≥ 2,4	30,0	1'600	+/-10
110	82,5	≥ 5,5	13,8	8'000	+/-10

standard coils for alternated current (other voltages on enquiry)

VAC					
12	10,2	≥ 0,6	260	10	+/-10
24	20,4	≥ 1,2	130	40	+/-10
48	40,8	≥ 2,4	60	180	+/-10
110	93,5	≥ 5,5	29	950	+/-10
220	187	≥ 11	14	3'900	+/-10

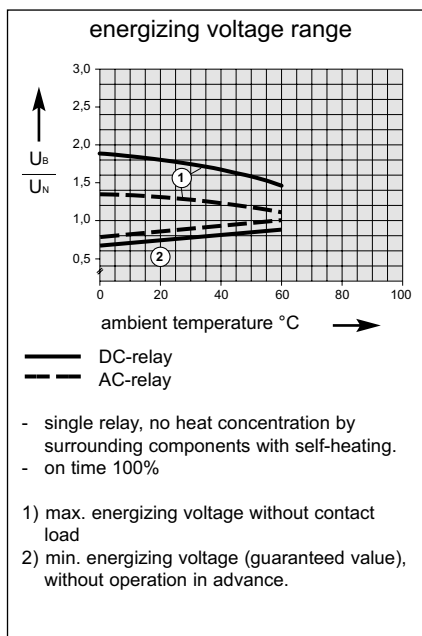

LR - contact specifications

AgCdO

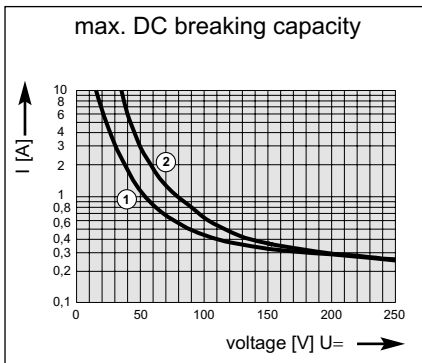

- 1 inductive load $L/R = 40$ ms
- 2 resistive load

data valid for relay

contact material

contact type

nominal switching capacity

electric life expectancy

inrush current max.

switching current range

switching power range

LR

AgCdO

single contact

250VAC 20A AC1 5000VA
400VAC 15A AC1

app. 900'000 operations
250 VAC 20A AC1 (360 Schaltung/h)

50A for 200 ms

500mA to 20A

8VA(W) to 5000VA(W)

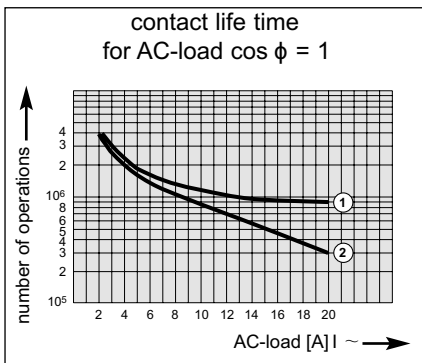

- 1: for 220 VAC (1-phase)
 - $I < 10$ A, max. 360 operations/h
 - $I > 10$ A, max. 180 operations/h
- 2: for 3 x 380 VAC (3-phase, star- or triangle circuit)
 - $I < 10$ A, max. 360 operations/h
 - $I > 10$ A, max. 180 operations/h

