



HART Multiplexer Master

HiDMux2700

- 32-channel
- 24 V DC supply
- HART field device input (revision 5 to 7)
- RS-485 interface
- Up to SIL 3 acc. to IEC/EN 61508

HART Multiplexer Master



Function

The HART Multiplexer Master provides 32 signal channels for connection to SMART transmitters or control devices supporting digital communication according to the HART standard. Full three-port isolation is included and each input channel has dual capacitor isolation for freedom of loop connection. Each HART Multiplexer Master is networked simply by connecting the high-speed RS 485 output in a multidrop configuration. The device interrogates each field device, under the supervision of the workstation, retrieving information for storage in its internal database, which is then easily accessed. This module is intended to mount on an HiD Termination Board or HART Communication Board. Also special boards for DCS integration are available. For additional information, refer to the manual and www.pepperl-fuchs.com.

Connection

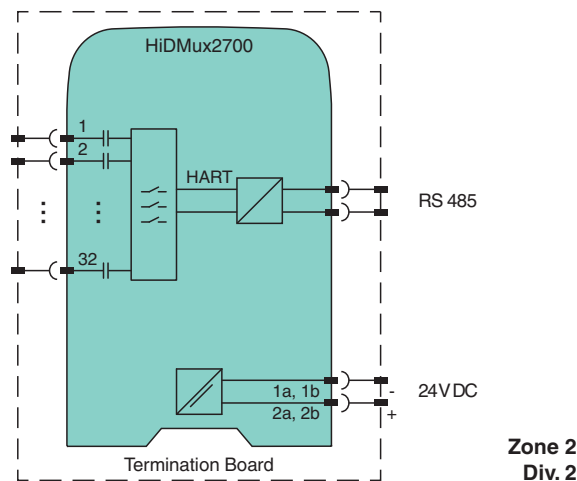

Technical Data

Functional safety related parameters	
Safety Integrity Level (SIL)	SIL 3
Supply	
Connection	SL1: 1a, 1b(-); 2a, 2b(+)
Rated voltage	U_r 20.4 ... 30 V DC via Termination Board
Rated current	I_r 28 mA at 24 V, RS-485, quiescent current
Power dissipation	0.7 W at 24 V
HART signal channels (non-intrinsically safe)	
Number of channels	32

Release date: 2023-05-31 Date of issue: 2023-05-31 Filename: 211968_eng.pdf

Refer to "General Notes Relating to Pepperl+Fuchs Product Information".

Pepperl+Fuchs Group
www.pepperl-fuchs.com

USA: +1 330 486 0002
pa-info@us.pepperl-fuchs.com

Germany: +49 621 776 2222
pa-info@de.pepperl-fuchs.com

Singapore: +65 6779 9091
pa-info@sg.pepperl-fuchs.com

PEPPERL+FUCHS

Technical Data

Conformity	HART field device input (revision 5 to 7)
Signal range	$0.12 V_{pp} < \text{signal} < 1.5 V_{pp}$
Leakage current	$< 3 \mu\text{A}$ at $-20 \dots 85 \text{ }^\circ\text{C}$ ($-4 \dots 185 \text{ }^\circ\text{F}$)
Terminating resistor	external $230 \dots 500 \Omega$ standard (up to 1000Ω possible)
Output voltage	$\geq 400 \text{ mV}_{ss}$ (with the terminator resistance specified above)
Output resistance	100Ω or smaller, capacitive coupling
DC isolation	dual capacitor each channel
Common mode voltage	up to 30 V
Input impedance	$> 5 \text{ k}\Omega$, according to HART specification
Input voltage range	$0.12 \dots 1.5 V_{ss}$
Common mode voltage	max. 30 V
Differential mode clamping	$\pm 5.2 \text{ V}$, for transient or AC signals
Common mode clamping	$\pm 10 \text{ V}$, for transient or AC signals
Carrier detect level	signal $> 0.12 V_{pp}$, carrier detection activated signal $< 0.08 V_{pp}$, carrier detection not activated
Transmit amplitude	200Ω load, $0.43 V_{pp} < \text{signal} < 0.49 V_{pp}$ 500Ω load, $1.1 V_{pp} < \text{signal} < 1.2 V_{pp}$
Device type	DC isolated bus device
Impedance	high impedance
Data link type	HART primary and secondary
Field multi point support	option available upon request
Interface	
Transfer rate	9600 MBit/s, 19200 MBit/s or 38400 MBit/s, selectable via switch
Address	1 ... 31, adjustable via DIP switch
Type	RS-485, differential pair and grounding
Topology	multi point, master/slave connection
Galvanic isolation	
Interface/power supply	$500 V_{rms}$
Interface/field channels	$1000 V_{eff}$
Power supply/field channels	$1000 V_{eff}$
Indicators/settings	
Display elements	LEDs LED PWR ON (power supply), one green LED LED HART TX (HART transmission), one yellow LED LED FAULT (lead fault), one red LED
Control elements	DIP switches at the housing side for: - unit slave address - baud rate - test mode on/off
Configuration	via DIP switches
Labeling	space for labeling at the front
Directive conformity	
Electromagnetic compatibility	
Directive 2014/30/EU	EN 61326-1:2013 (industrial locations)
Conformity	
Electromagnetic compatibility	NE 21:2012 For further information see system description.
Degree of protection	IEC 60529:2001
Ambient conditions	
Ambient temperature	$-20 \dots 60 \text{ }^\circ\text{C}$ ($-4 \dots 140 \text{ }^\circ\text{F}$)
Relative humidity	5 ... 95 %, noncondensing
Mechanical specifications	
Degree of protection	IP20
Mass	approx. 140 g
Dimensions	18 x 114 x 130 mm (0.7 x 4.5 x 5.1 inch) (W x H x D)
Mounting	on termination board

Release date: 2023-05-31 Date of issue: 2023-05-31 Filename: 211968_eng.pdf

Technical Data

Data for application in connection with hazardous areas	
Certificate	CML 17 ATEX 3337X
Marking	Ⓜ II 3G Ex ec IIC T4 Gc
Directive conformity	
Directive 2014/34/EU	EN IEC 60079-0:2018+AC:2020 , EN 60079-7:2015+A1:2018
International approvals	
CSA approval	
CSA certificate	1256050
Approved for	Class I, Division 2, Groups A, B, C, D and non-explosion hazardous area
IECEX approval	
IECEX certificate	IECEX CML 17.0178X
IECEX marking	Ex ec IIC T4 Gc
General information	
Supplementary information	Observe the certificates, declarations of conformity, instruction manuals, and manuals where applicable. For information see www.pepperl-fuchs.com .

Assembly

Front view

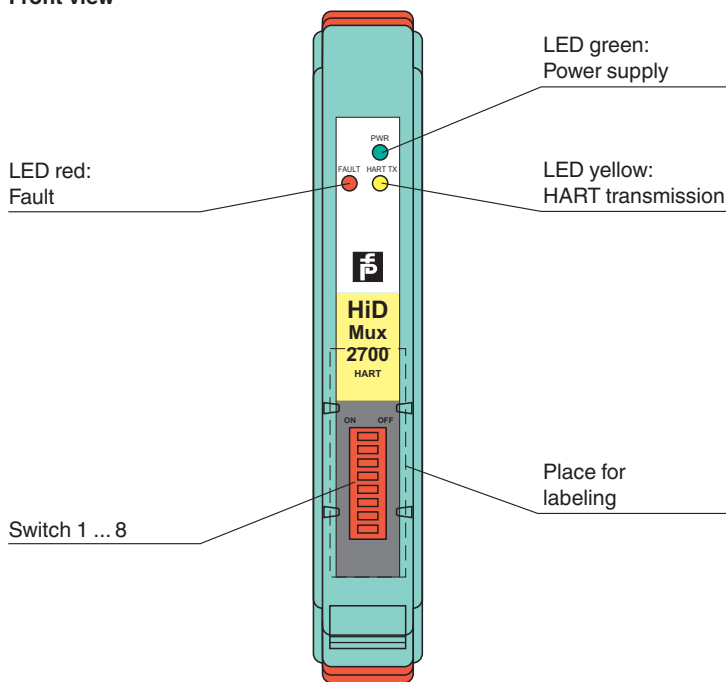

Additional Information

Conformity

The HART multiplexer main device generally complies with the HART FSK physical layer specification rev. 8.0 available from the HART Communication Foundation. HART is a registered trademark of the HART Communication Foundation.

High Specification Front End Design

Two decoupling capacitors are provided, one for each signal connection. Both the positive (+Ue) and the negative (-Ue) signal wires are therefore decoupled from DC signal. Only the high frequency digital HART protocol signal passes through to the internal multiplexer circuitry. Failure of any one capacitor from either a short circuit or open circuit means that availability of 4 ... 20 mA control signal will not be affected.

- no DC loading of 4 ... 20 mA control signal
- no single point of failure
- high noise immunity

The max. 30 V DC input voltage (specified between all terminals, both belonging to the same channel or not) makes it possible to connect any multiplexer terminal to whatever voltage level can be derived from a 24 V DC supply, +20 % tolerance included.

3 Port Isolation

The 3 port isolation structure of the HART multiplexer main device is depicted in the previous page. As you can see, both the 24 V supply input and the RS-485 serial interface are isolated from the HART section, i. e. from the HART signals on the field devices. This is full galvanic isolation, implemented either by transformer or by optocoupler.

Self Contained Architecture

Each HART multiplexer main device is a stand alone device containing all necessary hardware to communicate with up to 32 HART protocol enabled field devices and a host PC via RS-485 interface. The advantages are:

Release date: 2023-05-31 Date of issue: 2023-05-31 Filename: 211968_eng.pdf

Refer to "General Notes Relating to Pepperl+Fuchs Product Information".

Additional Information

- Fast polling
- One module design
- RS-485 interface direct from module
- No communications bottleneck
- Ideal for valve diagnostics















Wide Software Compatibility

The HART multiplexer main device is fully compatible with F-R AMS (ver 5.0 is also an OPC server), Valve Link and Cornerstone. Additional compatibility extends to HART OPC server software available from HCF (HART Communication Foundation). Allowing users to write dedicated applications for their specific needs. Fully tested, by all key PAM vendors.

Matching System Components

	ICDM-RX/TCP-ST/RJ45-DIN	Serial Device Server 1-port DIN Rail Screw Terminal
---	--------------------------------	---

Accessories

	HiSHPTB/32/TR-DO-01	HART Termination Board
	HiSHPTB/32/TR-AI-02	HART Termination Board
	HiSHPTB/32/TR-AI-03	HART Termination Board
	HiSHPMM/64/CONA-01	HART Termination Board
	HiSHPTB/32/YOK-AIO-R-02	HART Termination Board
	HiSHPTB/32/TR-AI-01	HART Termination Board
	DTM HART Comm	Device type manager (DTM) for HART communication
	DTM HART Multiplexer	Device type manager (DTM) for HART communication
	DTM Generic HART	Device type manager (DTM) for HART communication
	HiACA-UNI-FLK34-FLK34-0M5	HART Connection Cable, length: 0,5 m
	HiACA-UNI-FLK34-FLK34-1M0	HART Connection Cable, length: 1 m
	HiACA-UNI-FLK34-FLK34-2M0	HART Connection Cable, length: 2 m
	HiACA-UNI-FLK34-FLK34-3M0	HART Connection Cable, length: 3 m
	HiACA-UNI-FLK34-FLK34-6M0	HART Connection Cable, length: 6 m
	HiSHPSM/32/MM-01	HART Termination Board

Release date: 2023-05-31 Date of issue: 2023-05-31 Filename: 211968_eng.pdf

Refer to "General Notes Relating to Pepperl+Fuchs Product Information".

Accessories

 PACTware 5.0	FDT Framework
--	---------------

Release date: 2023-05-31 Date of issue: 2023-05-31 Filename: 211968_eng.pdf

Refer to "General Notes Relating to Pepperl+Fuchs Product Information".

Pepperl+Fuchs Group
www.pepperl-fuchs.com

USA: +1 330 486 0002
pa-info@us.pepperl-fuchs.com

Germany: +49 621 776 2222
pa-info@de.pepperl-fuchs.com

Singapore: +65 6779 9091
pa-info@sg.pepperl-fuchs.com

Configuration

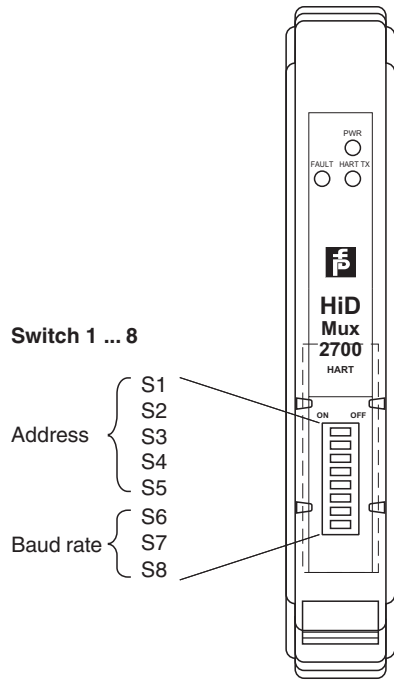

RS-485 Address					
	S1	S2	S3	S4	S5
1	ON	OFF	OFF	OFF	OFF
2	OFF	ON	OFF	OFF	OFF
3	ON	ON	OFF	OFF	OFF
4	OFF	OFF	ON	OFF	OFF
5	ON	OFF	ON	OFF	OFF
6	OFF	ON	ON	OFF	OFF
7	ON	ON	ON	OFF	OFF
8	OFF	OFF	OFF	ON	OFF
9	ON	OFF	OFF	ON	OFF
10	OFF	ON	OFF	ON	OFF
11	ON	ON	OFF	ON	OFF
12	OFF	OFF	ON	ON	OFF
13	ON	OFF	ON	ON	OFF
14	OFF	ON	ON	ON	OFF
15	ON	ON	ON	ON	OFF
16	OFF	OFF	OFF	OFF	ON
17	ON	OFF	OFF	OFF	ON
18	OFF	ON	OFF	OFF	ON
19	ON	ON	OFF	OFF	ON
20	OFF	OFF	ON	OFF	ON
21	ON	OFF	ON	OFF	ON
22	OFF	ON	ON	OFF	ON
23	ON	ON	ON	OFF	ON
24	OFF	OFF	OFF	ON	ON
25	ON	OFF	OFF	ON	ON
26	OFF	ON	OFF	ON	ON
27	ON	ON	OFF	ON	ON
28	OFF	OFF	ON	ON	ON
29	ON	OFF	ON	ON	ON
30	OFF	ON	ON	ON	ON
31	ON	ON	ON	ON	ON

RS-485 Baud Rate			
	S6	S7	S8
9600	OFF	OFF	OFF
19200	ON	OFF	OFF
38400	OFF	ON	OFF

Release date: 2023-05-31 Date of issue: 2023-05-31 Filename: 211988_eng.pdf