

DENSO Industrial Gas Plugs

The Iridium Saver Spark Plug Solution
For Your Industrial Engine Needs

Built to Exceed



DENSO
COMMERCIAL &
HEAVY DUTY

Iridium Saver

Designed For Long Plug Life

DENSO Offers Three Iridium Options

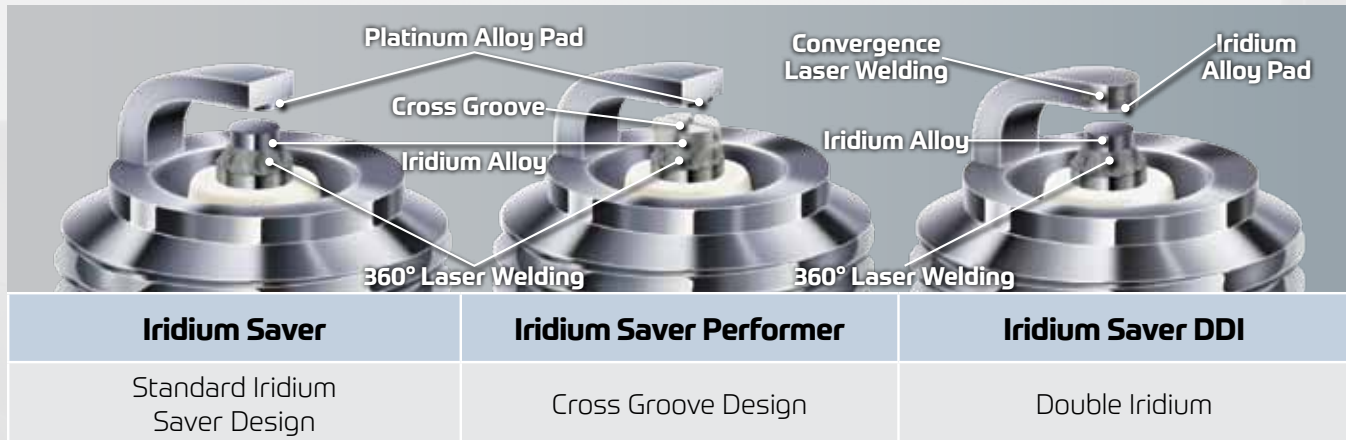

CROSS GROOVE DESIGN (M18MM PLUG)

The cross groove creates four small electrodes which improves sparking performance and suppresses dispersion in voltage value, for an outstanding decrease in voltage required.

*Only Iridium Saver Performer

UNIQUE IRIIDIUM ALLOY

Iridium alloy – developed and patented by DENSO – offers a high melting point which dramatically improves wear resistance compared to other Iridium plugs.

360° LASER WELDING

360° laser welding is used to create a seal so reliable the electrode resists wear even under the most extreme engine conditions.

PROVING LONGER LIFE

Using the same laser welding process as the Iridium Power spark plug, DENSO designed a long life spark plug for gas engines. With our patented Iridium alloy, DENSO was able to shrink the center electrode to 0.7mm, dramatically improving ignitability while maintaining longevity.

THE CROSS GROOVE DESIGN

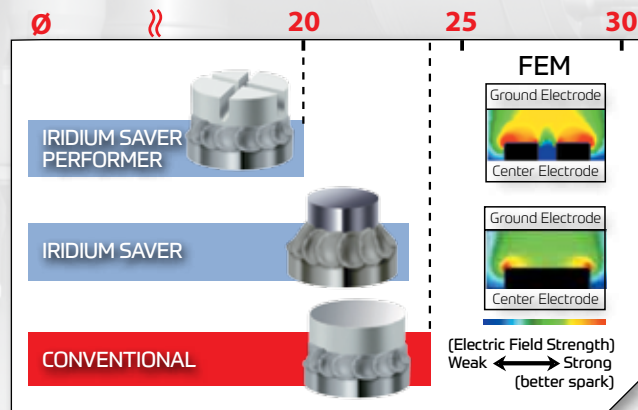

IGNITION VOLTAGE LIMIT

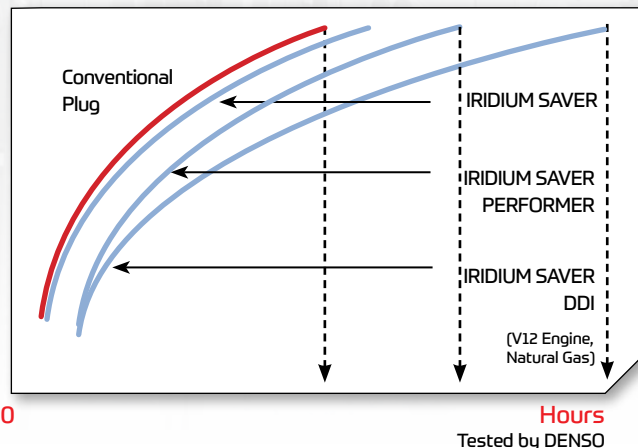

Iridium Saver

Designed For High Reliability

High Dielectric Ceramics

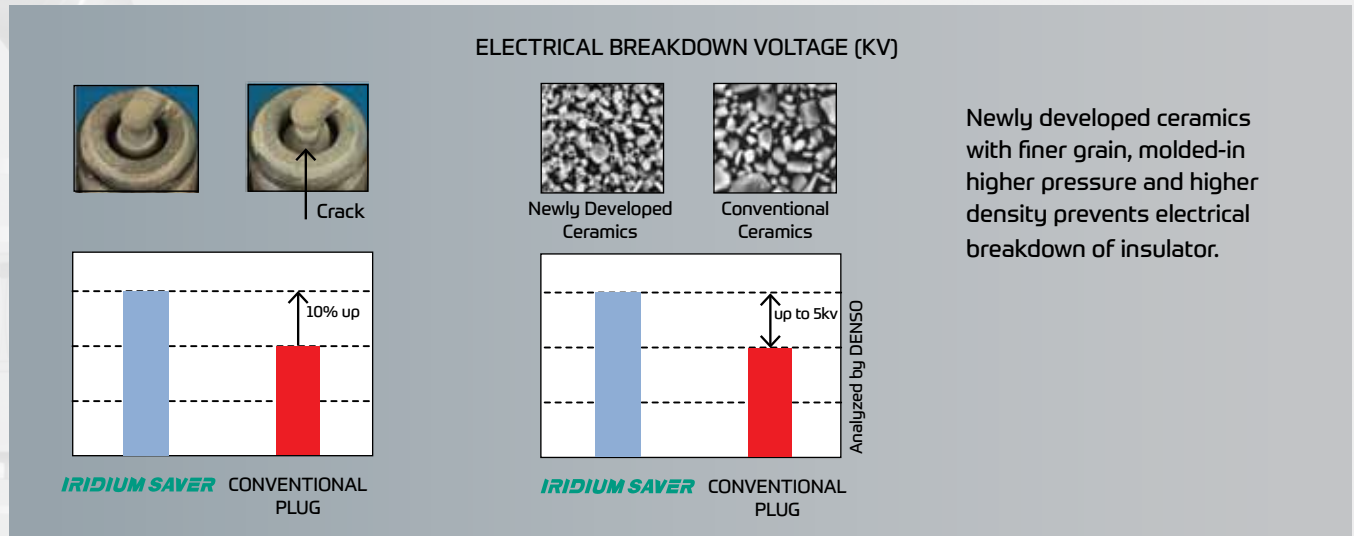

HIGHLY RELIABLE ROBUST CAULKING WITH POWDER SEAL AND HOT LOCK (M18MM PLUG)

For engines with higher combustion pressure, DENSO's robust caulking can secure air-tightness and prevent the caulk from loosening and ejecting the insulator.

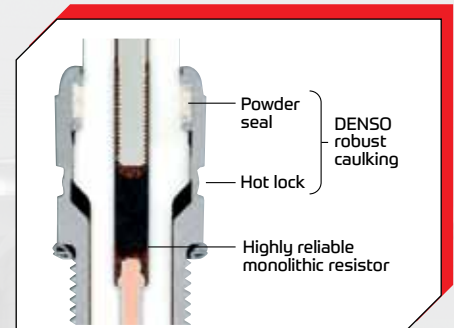

HIGHLY RELIABLE MONOLITHIC RESISTOR

The Iridium Saver design guarantees the reliability to withstand high combustion pressures by incorporating a stress resistant monolithic resistor that adheres to the resistor glass in high temperature environments. The resistor's purpose is to eliminate interference to electronic equipment from high energy coil noise.

EXPOSURE TEST BY ACID STREAM ATMOSPHERE

Test Length: 700 Hours
Temperature: 90°C Acid Water: pH=2

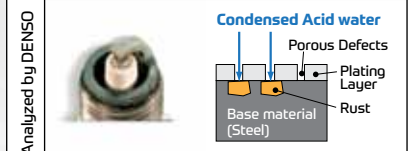

NORMAL PLUG

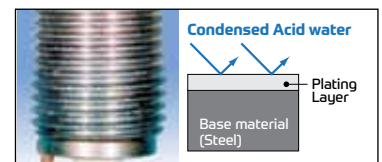

SPECIAL NICKEL PLATING WITH BETTER CORROSIVE RESISTANCE (ELECTROLESS PROCESS ELIMINATES POROUS DEFECTS)

Better corrosive resistance against condensed acid water.

Durable, Dependable, Quality

Recommended Tightening Torque

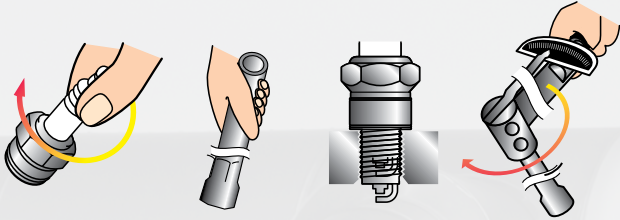

Thread size	Lubricant (on threads)	Recommended torque (cast iron head)	
M14 X 1.25	With lubricant	20 Nm	15 ft-lbs
	Without lubricant	30 Nm	22 ft-lbs
M18 X 1.5	With lubricant	30 Nm	22 ft-lbs
	Without lubricant	45 Nm	33 ft-lbs



Possible cause of shorter plug life

- Non high quality gas fuel such as bio-gas, landfill gas will accelerate wear of electrodes
- Increase in energy of ignition coil accelerating wear of electrodes
- Deterioration of ignition coil causing a decrease in ignition voltage being supplied to the spark plug
- Deterioration of plug boot decreasing flashover resistance

TIGHTENING TORQUE

Technician can examine gasket thickness to estimate if proper tightening torque was used.

▶ M14X1.25 With lubricant for cast iron head

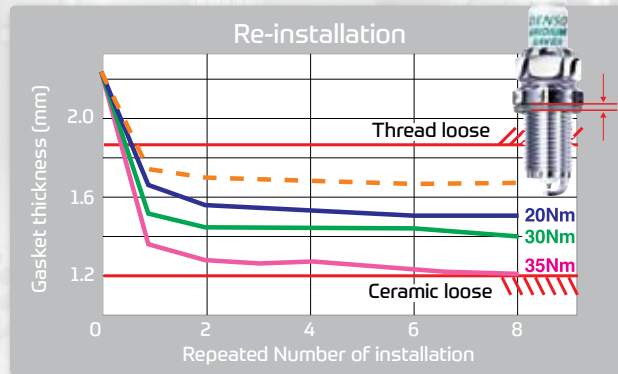
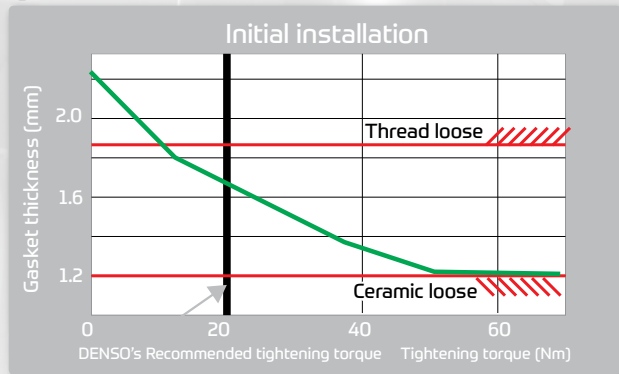

▶ M18X1.25 With lubricant for cast iron head

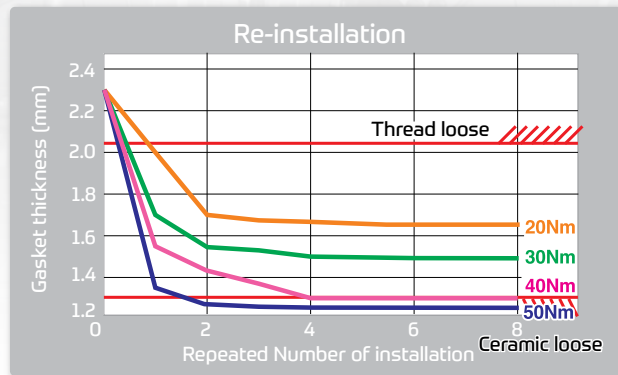
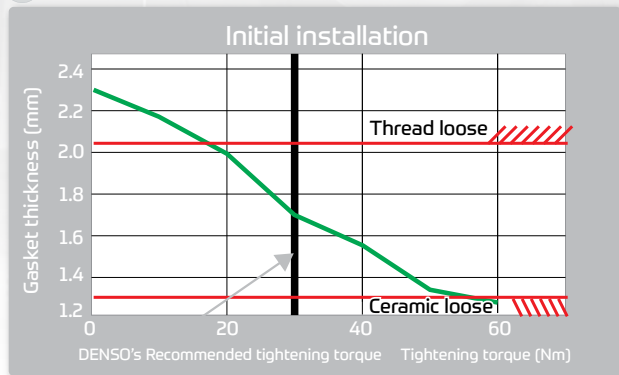

Durable, Dependable, Quality

CAULKING STRENGTH

To secure stable reliability, Iridium Saver adopts a robust structure, such as a robust monolithic structure in the insulator. The bottom portion of the insulator is housed by a metal shell with a robust caulking.



RESISTOR NOISE REDUCTION

The Iridium Saver design guarantees the reliability to withstand high combustion pressures by incorporating a stress resistant monolithic resistor that adheres to the resistor glass in high temperature environments. The resistor's purpose is to eliminate interference to electronic equipment from high energy coil noise.



Iridium Saver Application Information

ENGINE MAKER / TYPES	IRIDIUM SAVER	IRIDIUM SAVER PERFORMER	IRIDIUM SAVER DDI	GAP (INCH)
ARIEL				
JGS-1 High Tension	GE3-1		GE3-5	0.30mm (.012)
JGS-1 Low Tension	GE3-1		GE3-5	0.30mm (.012)
ARROWS				
VRG220, VRG330	GE3-1		GE3-5	0.30mm (.012)
BERNARD				
All Models	GN3-1			0.30mm (.012)
CASE				
A284, A377, 159G Natural & LP Gas		GT3-1		0.30mm (.012)
188G, 301G, 377G Natural & LP Gas		GT3-1		0.30mm (.012)
CATERPILLAR				
3306, G333 1/2" Reach	GN3-1			0.30mm (.012)
3306, G333 3/4" Reach, G343, G3304	GE3-1		GE3-5	0.30mm (.012)
G3400 series	GE3-1		GE3-5	0.30mm (.012)
G342, G353, G375, G379	GN3-1			0.30mm (.012)
G3500 Series (except C and E series with prechamber plugs)	GI3-3	GI3-1	GI3-5	0.28mm (.011)
G3600 series	GI3-3	GI3-1	GI3-5	0.28mm (.011)
G397, G398, G399	GN3-1			0.30mm (.012)
CHRYSLER				
Thru 1974 H225, HB-225	GE3-1		GE3-5	0.30mm (.012)
HB361, HB383, HC361, HT361	GE3-1		GE3-5	0.30mm (.012)
HB413, HC413, HB170	GE3-1		GE3-5	0.30mm (.012)
HT413, HB426, HC426, H170	GE3-1		GE3-5	0.30mm (.012)
IND53, IND56, IND56A	GE3-1		GE3-5	0.30mm (.012)
IND56, IND56A, LH318	GE3-1		GE3-5	0.30mm (.012)
H170, HB170, H225, HB225	GE3-1		GE3-5	0.30mm (.012)
HB361, HB383, HC361, HT361	GE3-1		GE3-5	0.30mm (.012)
HB413, HC413, HT413, HB426, HC426	GE3-1		GE3-5	0.30mm (.012)
COOPER-BESSEMER				
ENG, GNG		GT3-1		0.30mm (.012)
GDJ, GMA, GMB, GMC w/G402 Reducing Bushing		GT3-1		0.30mm (.012)
GDT, GFB, GFE, GFK w/G402 Reducing Bushing		GT3-1		0.30mm (.012)
CUMMINS				
6B, 6C, L-10, ISL-G	GK3-1A		GK3-5A	0.30mm (.012)
GNHC-4, GNH-220, GNH-250 1/2" Reach	GN3-1			0.30mm (.012)
G/GTA 5.9	GK3-1A		GK3-5A	0.30mm (.012)
G 8.3C	GK3-1A		GK3-5A	0.30mm (.012)
GTA 8.3	GE5-1			0.50mm (.020)
GV-12450, GM-12-525 3/8" Reach	GN3-1			0.30mm (.012)
GV-12450, GV-12-525 1/2" Reach	GN3-1			0.30mm (.012)
No. 173416 5/8" Reach w/N677 Gasket (w/ special adapter)	GE3-1		GE3-5	0.30mm (.012)

ENGINE MAKER / TYPES	IRIDIUM SAVER	IRIDIUM SAVER PERFORMER	IRIDIUM SAVER DDI	GAP (INCH)
No. 90210035, 90210036 3/4" Reach	GE3-1		GE3-5	0.30mm (.012)
Q19G, QSV 81, QSV 91, QSK 19G, QSK 38G, QSK 45G, QSK 50G, QSK 60G	GI3-3	GI3-1	GI3-5	0.28mm (.011)
ISL-G, ISC-G, ISX-12*	GK3-7			0.30mm (.012)
DAE WOO				
GV222TIC, GE08TIC, GE12TIC, GV180TIC, GV158TIC	GK3-1A		GK3-5A	0.30mm (.012)
DEUTZ MWM				
G620 V-8, TBG616 V-8, TBG616 V-12	GL3-3	GL3-1	GL3-5	0.28mm (.011)
TBG441BV12, TBG441BV16	GL3-3	GL3-1	GL3-5	0.28mm (.011)
TBG616K V-8K, TBG616K V-12, TBG616K V-16K	GL3-3	GL3-1	GL3-5	0.28mm (.011)
TBG620 V-8, TBG620 V-12, TBG620 V-16	GL3-3	GL3-1	GL3-5	0.28mm (.011)
TBG620K V-12K TBG620K V-16K	GL3-3	GL3-1	GL3-5	0.28mm (.011)
DORMAN				
3DAG, 4DAG, 6DAG, 6QG, D ATG4, 6	GE3-1		GE3-5	0.30mm (.012)
6LEG	GN3-1			0.30mm (.012)
6SEG, 8SEG, 12SEG	GE3-1		GE3-5	0.30mm (.012)
6SETCWG MinNox	GE3-1		GE3-5	0.30mm (.012)
6PG, 12PG		GT3-1		0.30mm (.012)
12S, 12SG, 12STCWG, 12STCAG		GT3-1		0.30mm (.012)
DRESSER CLARK				
TLA6	GK3-1		GK3-5	0.30mm (.012)
FAIRBANKS MORSE				
38D8-1/8 Series		GT3-1		0.30mm (.012)
FORD				
158, 175, 201, 256 cid	GE3-1		GE3-5	0.30mm (.012)
FUJI-ROBIN				
EC-05, EC-07, FG-14	GN3-1			0.30mm (.012)
EY-13, EY-18, EY-25, EY-33	GN3-1			0.30mm (.012)
EY-27, EY-14, EY-40, EC-16	GN3-1			0.30mm (.012)
EY-44, EY-88, EC-03, EC-04	GN3-1			0.30mm (.012)
GEMINI				
G26, G35	GN3-1			0.30mm (.012)
GUASCOR				
FG180, FGLD180, FG240	GI3-3	GI3-1	GI3-5	0.28mm (.011)
FGLD240, FGLD360,	GI3-3	GI3-1	GI3-5	0.28mm (.011)
FGLD480, FGLD560	GI3-3	GI3-1	GI3-5	0.28mm (.011)
GE JENBACHER				
J612, J616, J629 (BMEP = 16 bar or less)	GI3-3	GI3-1	GI3-5	0.28mm (.011)
GM				
305, 351, 401, 478, 702, CNG, Gasoline	GE3-1		GE3-5A	0.30mm (.012)
305, 351, 401, 478, 702 LPG, CNG	GE3-1		GE3-5A	0.30mm (.012)

* The GK3-7 can be used in the ISX-12 Engines. The plug is exactly the same except the GK3-7 has the two extra "shield" electrodes.

Iridium Saver Application Information

ENGINE MAKER / TYPES	IRIDIUM SAVER	IRIDIUM SAVER PERFORMER	IRIDIUM SAVER DDI	GAP (INCH)
HERCULES				
G4800, GTA4800	GK3-1A			0.30mm (.012)
INTERNATIONAL				
C-537, C-605	GE3-1		GE3-5	0.30mm (.012)
U817, U817B, UT817, UT817B (14mm Heads)	GN3-1			0.30mm (.012)
JLO - ROCKWELL				
G49, L35, L77, LV298, MM25, MM40	GN3-1			0.30mm (.012)
GA50 Updated Version, V49	GN3-1			0.30mm (.012)
JOHN DEERE				
6.8L, 8.1L	GK3-1A		GK3-5A	0.30mm (.012)
300 Series	GE3-1		GE3-5	0.30mm (.012)
400, 500 Series Natural & LP Gas		GT3-1		0.30mm (.012)
6076AFN30 (150, 200 H.P.)	GK3-1A		GK3-5A	0.30mm (.012)
6081HFN, 6090HFN	GK3-1A			0.30mm (.012)
J-W POWER				
Superburn Pre-Cell	GE3-1		GE3-5	0.30mm (.012)
LIEBHERR				
G 924 T	GE3-1		GE3-5	0.30mm (.012)
G 924 TC	GE3-1		GE3-5	0.30mm (.012)
G 926 T	GE3-1		GE3-5	0.30mm (.012)
G 926 TC	GE3-1		GE3-5	0.30mm (.012)
G 926 TC 40	GE3-1		GE3-5	0.30mm (.012)
G 9408 TC	GK3-1A		GK3-5A	0.30mm (.012)
G 9408 TC 40	GK3-1A		GK3-5A	0.30mm (.012)
MAN				
E 0824 E 301, E 0824 E 302, E 0826 E301, E 0826 E302, E 2842, E 2842 LE, E 2843 LN, E 2876, E 2866 LUH01	GE3-1		GE3-5	0.30mm (.012)
E 0834, E0836	GK3-1A			0.30mm (.012)
E 2866 DUH03	GE5-1			0.5mm (.020)
M.E.P. INDUSTRIES				
M.E.P.-6, -8, -10, -12		GT3-1		0.30mm (.012)
MINNEAPOLIS - MOLINE				
NATURAL & LP-GAS 206-4A, 220-4, HD220-4A, M220-A4A		GT3-1		0.30mm (.012)
283-4A, HD504-6A		GT3-1		0.30mm (.012)
336A-4A, HD425-6A, HD504A-6A		GT3-1		0.30mm (.012)
605A-6A, 605B-6A, HD605-6A		GT3-1		0.30mm (.012)
HD800-6A, HD800A-6A, 1210-12A		GT3-1		0.30mm (.012)
PERKINS				
G4-203, G4-236, 900 Series	GE5-1			0.5mm (.020)
4000 Series	GI3-3	GI3-1	GI3-5	0.28mm (.011)

ENGINE MAKER / TYPES	IRIDIUM SAVER	IRIDIUM SAVER PERFORMER	IRIDIUM SAVER DDI	GAP (INCH)
RATHBUN JONES				
Models w/G-402 Reducing Bushing		GT3-1		0.30mm (.012)
ROILINE				
F1500, H2000, H2470 (Light Load)		GT3-1		0.30mm (.012)
F1500, H2000, H2470 (Heavy Load)		GT3-1		0.30mm (.012)
H540, H844, H570, H884		GT3-1		0.30mm (.012)
L3230, L3460, L4000 (Light Load)		GT3-1		0.30mm (.012)
L3230, L3460, L4000 (Heavy Load)		GT3-1		0.30mm (.012)
F1500, F1850, H2000, H2150, H2470		GT3-1		0.30mm (.012)
L3000, L3230, L3460, L4000		GT3-1		0.30mm (.012)
ROTAX				
370cc Normal & Severe Service	GN3-1			0.30mm (.012)
SACHS				
504 Series, 505 Series, 508, Stamo SL-2	GN3-1			0.30mm (.012)
SACM				
Model UD30 Thru 1994	GK3-1A		GK3-5A	0.30mm (.012)
Model 175 1996 & up	GK3-1A		GK3-5A	0.30mm (.012)
SUPERIOR				
1706G2, 1712G1, 2400 G Series	GI3-3	GI3-1	GI3-5	0.28mm (.011)
1980-46 G510 Series		GT3-1		0.30mm (.012)
1980-51 G825 Series		GT3-1		0.30mm (.012)
1979-65 GT825 Series		GT3-1		0.30mm (.012)
1980-79 GTL Series		GT3-1		0.30mm (.012)
1980-61 GT510 Series		GT3-1		0.30mm (.012)
1965-58 GX825 Series		GT3-1		0.30mm (.012)
1980-76 SGT Series		GT3-1		0.30mm (.012)
VOLKSWAGEN				
Models 122, 124A Gasoline, Natural Gas & LPG	GN3-1A			0.30mm (.012)
VOLVO TRUCK				
GH10C, MG9	GE3-1		GE3-5	0.30mm (.012)
WAUKESHA				
AT Series				
8L-AT25GL / AT27GL (13/16" Reach Heads)	GI3-3	GI3-1	GI3-5	0.28mm (.011)
L5794GSI, L5794LT	GI3-3	GI3-1	GI3-5	0.28mm (.011)
L7044G (VHP Series V-12), L7044GL (VHP Series V-12), L7044GSI VHP Series V-12)	GI3-3	GI3-1	GI3-5	0.28mm (.011)
F3524GSI, H24GL, L36GL, L36GSI	GI3-3	GI3-1	GI3-5	0.28mm (.011)
F2895G, F2895GL, F2895GSI, F3521G, F3521GL, F3521GSI		GT3-1		0.30mm (.012)

Iridium Saver Application Information

ENGINE MAKER / TYPES	IRIDIUM SAVER	IRIDIUM SAVER PERFORMER	IRIDIUM SAVER DDI	GAP (INCH)
L5108G, L5108GL, L5108GSI, L5790G, L5790GL, L5790GSI		GT3-1		0.30mm (.012)
L7040G, L7042G, L7042GL, L7042GSI		GT3-1		0.30mm (.012)
P9390GL, P9390GSI		GT3-1		0.30mm (.012)
12VAT25GL, 12VAT27GL, F11G, F11GSI, F18GL, F18GLD, F18GSI	GI3-3	GI3-1	GI3-5	0.28mm (.011)
8L-AT25GL/AT27GL (1/2" Reach Heads)		GT3-1		0.30mm (.012)
12V-AT25GL / AT27GL (13/16" Reach Heads)	GI3-3	GI3-1	GI3-5	0.28mm (.011)
12V-AT25GL/AT27GL (1/2" Reach Heads)		GT3-1		0.30mm (.012)
Intermediate Series				
F1905GR		GT3-1		0.30mm (.012)
Natural & LP-Gas / 14mm Heads				
H1077G, H1077GSI, L1616G, L1616GSI	GE3-1		GE3-5	0.30mm (.012)
VRG220, VRG330	GE3-1		GE3-5	0.30mm (.012)
VRN265, VRN283, VRN310	GE3-1		GE3-5	0.30mm (.012)
VG Series Inline 6				
F18G, F18GL / GLD	GI3-3	GI3-1	GI3-5	0.28mm (.011)
VG Series Inline 8				
H24G, H24GL / GLD	GI3-3	GI3-1	GI3-5	0.28mm (.011)
VG Series V-12				
L36GL / GLD	GI3-3	GI3-1	GI3-5	0.28mm (.011)
VG Series V-16				
P48GL GLD	GI3-3	GI3-1	GI3-5	0.28mm (.011)
VHP Series Inline 6				
2895GL (13/16" Reach Heads)	GI3-3	GI3-1	GI3-5	0.28mm (.011)
3521GL (13/16" Reach Heads)	GI3-3	GI3-1	GI3-5	0.28mm (.011)
2895GL (1/2" Reach Heads)		GT3-1		0.30mm (.012)
3521GL (1/2" Reach Heads)		GT3-1		0.30mm (.012)
F2895G, F2895GSI		GT3-1		0.30mm (.012)
F3521G, F3521GSI		GT3-1		0.30mm (.012)
VHP Series V-12				
L5108GL (13/16" Reach Heads)	GI3-3	GI3-1	GI3-5	0.28mm (.011)
L5790GL (13/16" Reach Heads)	GI3-3	GI3-1	GI3-5	0.28mm (.011)
L7042GL (13/16" Reach Heads)	GI3-3	GI3-1	GI3-5	0.28mm (.011)
L5108G, L5108GSI, L5790G		GT3-1		0.30mm (.012)
L5790GSI, L7042G, L7042GSI		GT3-1		0.30mm (.012)
5108GL (1/2" Reach Heads)		GT3-1		0.30mm (.012)
5790GL (1/2" Reach Heads)		GT3-1		0.30mm (.012)
7042GL (1/2" Reach Heads)		GT3-1		0.30mm (.012)
VHP Series V-16				
P5115GL	GI3-3	GI3-1	GI3-5	0.28mm (.011)
P9390GL (13/16" Reach Heads)	GI3-3	GI3-1	GI3-5	0.28mm (.011)
9390G, P9390GSI		GT3-1		0.30mm (.012)

ENGINE MAKER / TYPES	IRIDIUM SAVER	IRIDIUM SAVER PERFORMER	IRIDIUM SAVER DDI	GAP (INCH)
9390GL (1/2" Reach Heads)		GT3-1		0.30mm (.012)
VSG Series				
F11G, F11GSI / CSID, P2154G, P2154GSI	GE3-1		GE3-5	0.30mm (.012)
H1077G, H1077GSI, L1616G, L1616GSI	GE3-1		GE3-5	0.30mm (.012)
VSG Series / 18mm Heads				
F1197GRSI, F1905GRSI, Generator Set		GT3-1		0.30mm (.012)
F2894G, F2894GRSI, F3520G, L5100GR		GT3-1		0.30mm (.012)
L5788GRSI, L7040G		GT3-1		0.30mm (.012)
L5100GRSI, L5788GR		GT3-1		0.30mm (.012)
L7042GSIE, F3521GSIE		GT3-1		0.30mm (.012)
6BZ, 6LRZ, 6LRZB, 6MZA, 6MZR, ICK		GT3-1		0.30mm (.012)
6NK, 6WAK, 6WAKB, NKRB, WAKR, LRORB		GT3-1		0.30mm (.012)
140GK, 145GK, FC		GT3-1		0.30mm (.012)
180G, 180GB, 180GKB, 185GLB		GT3-1		0.30mm (.012)
190G, 190GLB, 195G, 195GK		GT3-1		0.30mm (.012)
WISCONSIN				
W2-1230 Serial #5996538 & Up	GE3-1		GE3-5	0.30mm (.012)
W2-1235, W4-2460, W2-1250	GE3-1		GE3-5	0.30mm (.012)
WISCONSIN - ROBIN				
EY18-3W, EY25W Gasoline	GN3-1			0.30mm (.012)
EY18W, EY21W, EY27W, EY44W	GN3-1			0.30mm (.012)
WT-125V, W1-450V	GN3-1			0.30mm (.012)
W1-145, W1-390, W1-185, W1-340	GN3-1			0.30mm (.012)
WITTE				
G-260	GN3-1			0.30mm (.012)
YAMAHA				
AS110	GN3-1			0.30mm (.012)

NOW AVAILABLE: BOOT KIT FOR IRIDIUM SAVER SPARK PLUG FOR CUMMINS ISL ENGINES

BOOT - Cummins

ENGINE MAKER / TYPES	PART NUMBER
ISL-G	674-1000

IRIDIUM SAVER BENEFITS

- Unique Iridium Alloy
- 360 Laser Welding
- Highly reliable Monolithic Resistor
- Special nickel plating with better corrosive resistance
- High dielectric ceramics

To place your order, please contact Customer Service at 877-675-5463 or customer_service@densodrive.com

Cross Reference

CHAMPION	CHAMPION Premium	STITT	GATEWAY	ALTRONIC	BOSCH	CAT (OES)	Waukesha (OES)	CUMMINS (OES)	IRIDIUM SAVER	IRIDIUM SAVER PERFORMER	IRIDIUM SAVER DDI
RB77CC, RB77N, KB75N, RB75N			1175112	L1863B	7302	194-8518	60999Z	4098162	GI3-3	GI3-1	GI3-5
RB77WPC			1177512	L1863IP	7305	224-2700	60999Z	4010981	GI3-3	GI3-1	GI3-5
RB77WPCC	FB77WPCC		1177512	L1863IP	7305	243-4291	60999Z	2866879	GI3-3	GI3-1	GI3-5
KB77WPCC			1177512	L1863IP	7306	301-6663	69919D	2866879	GI3-3	GI3-1	GI3-5
RB75N		RL807LL	1175112	L1863B	7307, 7308				GL3-3	GL3-1	GL3-5
RB75PP		RL807LL	1175112	L1863DP	7307, 7308				GL3-3	GL3-1	GL3-5
RB75WPC		RL807LL	1175112	L1863IP	7307, 7308				GL3-3	GL3-1	GL3-5
RB75WPCC		RL807LL	1175112	L1863IP	7307, 7308				GL3-3	GL3-1	GL3-5
RB76N/RB76N			1175112						GI3-3	GI3-1	GI3-5
RB76PP			1176112						GI3-3	GI3-1	GI3-5
RN79G, RN79G1	RN79PYP17, RN79PYP25	R407XL	8179215	J1463DP	7311, 7315	104-3170, 4W-2256, 128-6238, 2N2839		4090121	GE3-1		GE3-5A
RC78PYP*, RC78PYP15, RC78PYP17, RC78PYP21, RC78PYP25	RC78WP, RC78WYP11, RC78WP15		2178315		7321	104-3170		4089085, 4089086, 4025416	GK3-1A		GK3-5A
RC78YCC15			2178315		7321				GK3-1A		GK3-5A
RL15B	RL85G	R407L	6115615	J1443DP		2N0553			GN3-1A		
RM77N		R807	7177315	L1843B	7303		CHARM77N.020			GT3-1	
RM77PP		R807	7177315	L1843IP	7303		CHARM77N.020			GT3-1	
** Insulator length of RC78PYP and RC78WYP15 is 5mm longer than GK3-5A, GK3-1A and GK3-3A.								3973945	ISL-G BOOT		674-1000

SPECIFICATIONS

G **K** **3** - **1**

Initial Gap	
Number	Nominal Value
3	0.3mm
4	0.4mm
5	0.5mm

FOR GAS ENGINE

Plug Type and Installation Dimension			
Letter	Thread	Hex Size	Reach
E	M 14 x 1.25	20.8mm	19mm
N			12.7mm
K		16mm	19mm
L	M 18 x 1.5	20.8mm	20.6mm
I			22.2mm
T			

Plug Type and Installation Dimension	
1. IRIDIUM SAVER	Iridium pad without cross groove on center electrode and Platinum pad on ground electrode.
3. IRIDIUM SAVER	For vehicle
5. IRIDIUM SAVER DDI (DENSO Double Iridium)	Iridium pad without cross groove on center electrode and Iridium pad on ground electrode.
7. 3-PRONG IRIDIUM SAVER	Iridium pad without cross groove on center electrode, three ground electrodes (for spark efficiency), and Platinum pad on middle ground electrode.
1. IRIDIUM SAVER PERFORMER	Iridium pad with cross groove on center electrode and Platinum pad on ground electrode.
3. IRIDIUM SAVER	Iridium pad without cross groove on center electrode and Platinum pad on ground electrode.
5. IRIDIUM SAVER DDI (DENSO Double Iridium)	Iridium pad without cross groove on center electrode and Iridium pad on ground electrode.

DENSO Iridium Saver

M18mm Plugs

G13-1 G13-3 G13-5

GL3-1 GL3-3 GL3-5

GT3-1

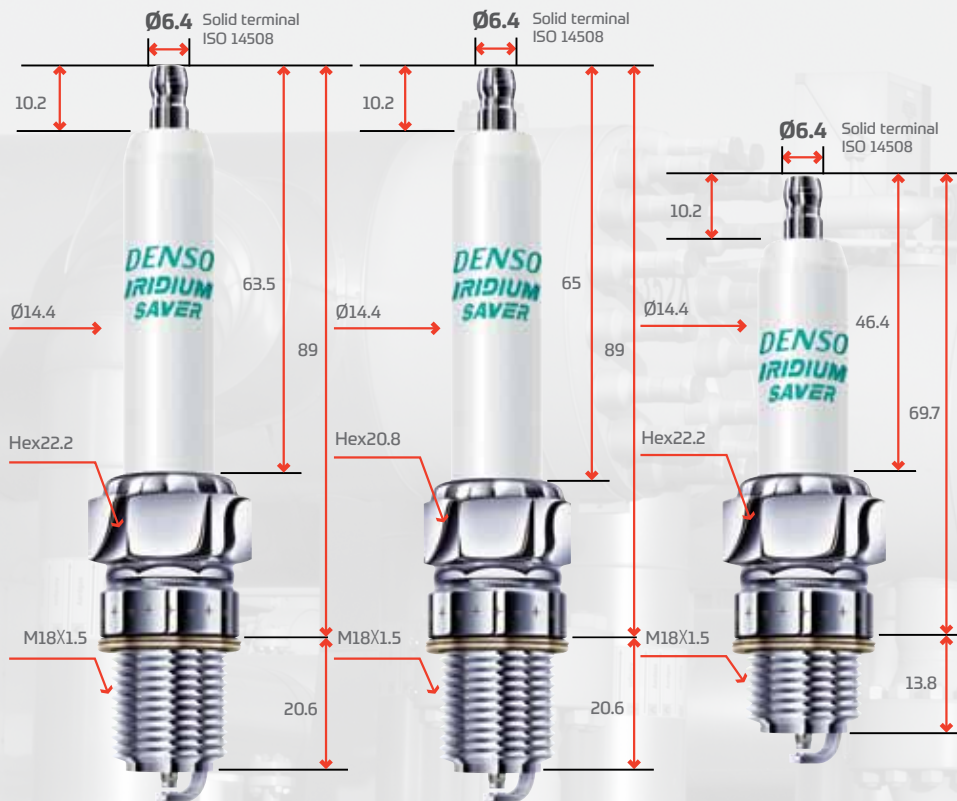

IRIDIUM SAVER

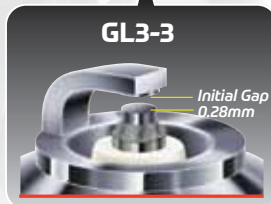

IRIDIUM SAVER PERFORMER

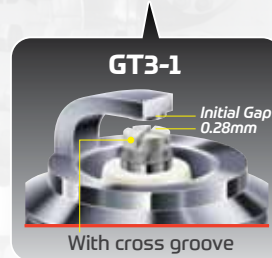

IRIDIUM SAVER DDI

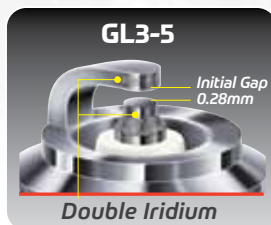
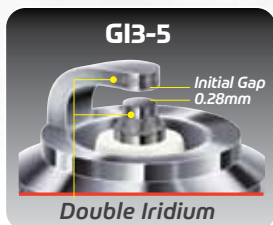

DENSO Iridium Saver

M14mm Plugs

GE3-1 GE5-1 GE3-5

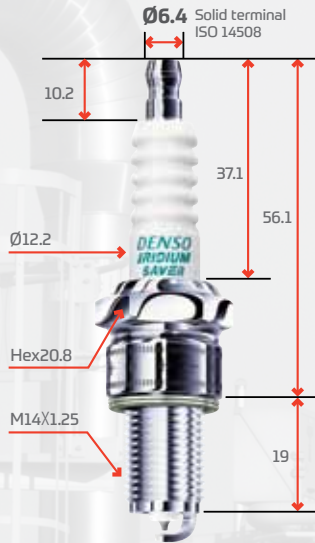

GN3-1A



GK3-1A GK3-5A

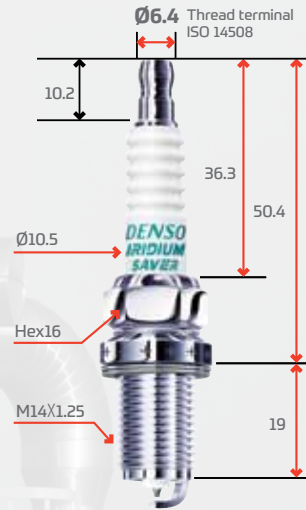

GK3-7

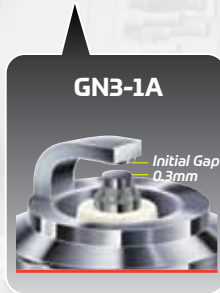
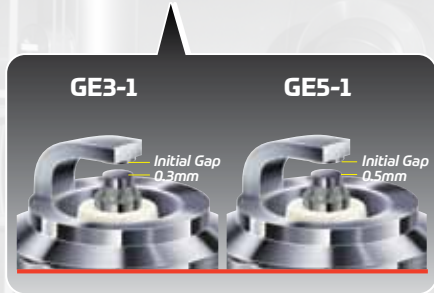
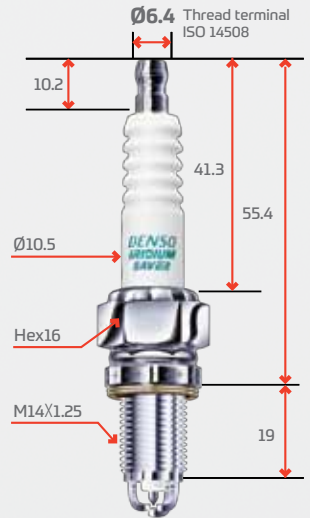

IRIDIUM SAVER

IRIDIUM SAVER

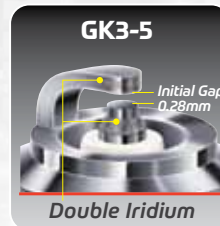
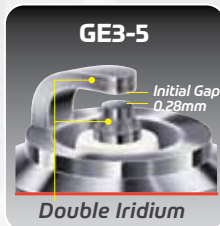

IRIDIUM SAVER DDI

Built to Exceed

DENSO is a leading supplier of advance automotive technology, systems, and components for major OEMs. Major truck & equipment manufacturers rely on DENSO products and technologies, including Iridium Spark Plugs for the demanding needs of their commercial engines.



**COMMERCIAL &
HEAVY DUTY**

DENSOHeavyDuty.com
DENSO Products and Services Americas, Inc.
3900 Via Oro Avenue, Long Beach, CA 90810 310.834.6352

Copyright© 2015, DENSO.

D1517.331