

41802 ✓ ACTIVE

FASTON 250

TE Internal #: 41802

Quick Disconnects, Receptacle, 18 – 12 AWG Wire Size, .82 – 3.31 mm² Wire Size, Mating Tab Width 6.35 mm [.25 in], Flag, Brass, FASTON 250

[View on TE.com >](#)



Terminals & Splices > Quick Disconnects

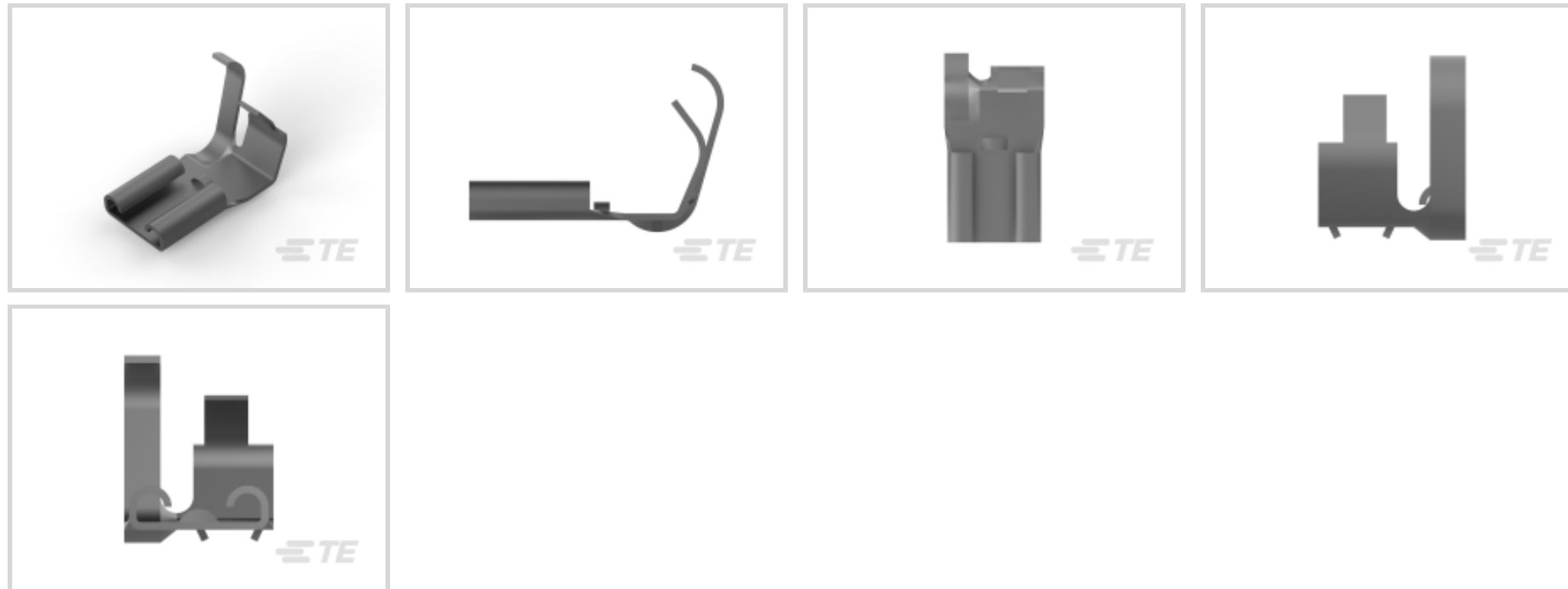

Quick Disconnect Terminal Type: **Receptacle**

Wire Size: .82 – 3.31 mm²

Mating Tab Width: 6.35 mm [.25 in]

Mating Tab Thickness: .81 mm [.032 in]

Features

Product Type Features

Insertion Force	Normal
-----------------	--------

Configuration Features

Connection Capacity	Single
Compatible With Wire & Cable Type	Discrete Wire

Contact Features

Quick Disconnect Terminal Type	Receptacle
Mating Tab Width	6.35 mm [.25 in]
Mating Tab Thickness	.81 mm [.032 in]
Terminal Orientation	Flag
Contact Base Material	Brass
Terminal Plating Material	Tin
Crimp Type	Tab-Lok
Barrel Type	Open

Termination Features

--	--



Product Terminates To	Wire & Cable
-----------------------	--------------

Mechanical Attachment

Wire Insulation Support	With
Mating Retention Type	Dimple

Dimensions

Terminal Material Thickness	.43 mm[.017 in]
Product Length	17.02 mm[.67 in]
Compatible Insulation Diameter Range	2.79 – 5.33 mm[.11 – .21 in]
Wire Size	.82 – 3.31 mm ²

Usage Conditions

Insulation Option	Uninsulated
Operating Temperature Range	-40 – 110 °C[-40 – 230 °F]

Industry Standards

Agency/Standard	CSA, UL
-----------------	---------

Packaging Features

Packaging Quantity	4000
Packaging Method	Strip/Reel

Other

Line	Premier
------	---------

Product Compliance











[For compliance documentation, visit the product page on TE.com>](#)

EU RoHS Directive 2011/65/EU	Compliant
EU ELV Directive 2000/53/EC	Compliant
China RoHS 2 Directive MIIT Order No 32, 2016	No Restricted Materials Above Threshold
EU REACH Regulation (EC) No. 1907/2006	Current ECHA Candidate List: JAN 2023 (233) Candidate List Declared Against: JAN 2023 (233) Does not contain REACH SVHC
Halogen Content	Low Halogen - Br, Cl, F, I < 900 ppm per homogenous material. Also BFR/CFR/PVC Free
Solder Process Capability	Not applicable for solder process capability

Product Compliance Disclaimer

This information is provided based on reasonable inquiry of our suppliers and represents our current actual knowledge based on the information they provided. This information is subject to change. The part numbers that TE has identified as EU RoHS compliant have a maximum concentration of 0.1% by weight in homogenous materials for lead, hexavalent chromium, mercury, PBB, PBDE, DBP, BBP, DEHP, DIBP, and 0.01% for cadmium, or qualify for an exemption to these limits as defined in the Annexes of Directive 2011/65/EU (RoHS2). Finished electrical and electronic equipment products will be CE marked as required by Directive 2011/65/EU. Components may not be CE marked. Additionally, the part numbers that TE has identified as EU ELV compliant have a maximum concentration of 0.1% by weight in homogenous materials for lead, hexavalent chromium, and mercury, and 0.01% for cadmium, or qualify for an exemption to these limits as defined in the Annexes of Directive 2000/53/EC (ELV). Regarding the REACH Regulation, the information TE provides on SVHC in articles for this part number is based on the latest European Chemicals Agency (ECHA) 'Guidance on requirements for substances in articles' posted at this URL: <https://echa.europa.eu/guidance-documents/guidance-on-reach>

Compatible Parts

 <p>TE Part # 2232111-1 250 FASTON,FLAG,REC.,12-20 AWG, TPBR</p>	 <p>TE Part # 63617-1 250 FASTON FLAG REC 12-10 AWG BR</p>	 <p>TE Part # 1-687395-8 HINGE BAR 9EAPR160T180O G</p>	 <p>TE Part # 1852633-1 EAPOHB160TABLOCK180O LM/G-HINGE BAR</p>
 <p>TE Part # 1855041-1 HINDGE BAR F.A. EMPO160TAB180O LM & G</p>	 <p>TE Part # 2232111-3 250 FASTON,FLAG,REC.,12-20 AWG, TPBR</p>	 <p>TE Part # 687395-5 M HBEAPR160T K</p>	 <p>TE Part # 687395-6 HDM HBEAPR160T180OTS A</p>
 <p>TE Part # 687395-8 HINGE BAR 9EAPR160T180O G</p>	 <p>KIT REPRESENTATION ONLY</p> <p>TE Part # 7-1855041-7 SPARE PART KIT</p>	<p>TE Part # 1596696-2 HB APPL,AOL</p>	<p>TE Part # 1596697-5 HB APPL,AOM</p>



TE Part # 2088156-2
MINI APPLICATOR, HINGE BAR END FEED



TE Part # 565504-1
STD HBEMPR160T180OK



TE Part # 565504-3
STD HBEMPR160T220OK

Also in the Series | **FASTON 250**

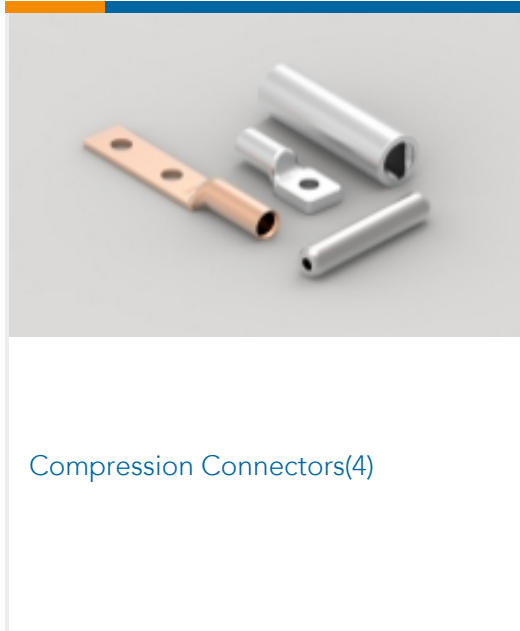

Compression Connectors(4)

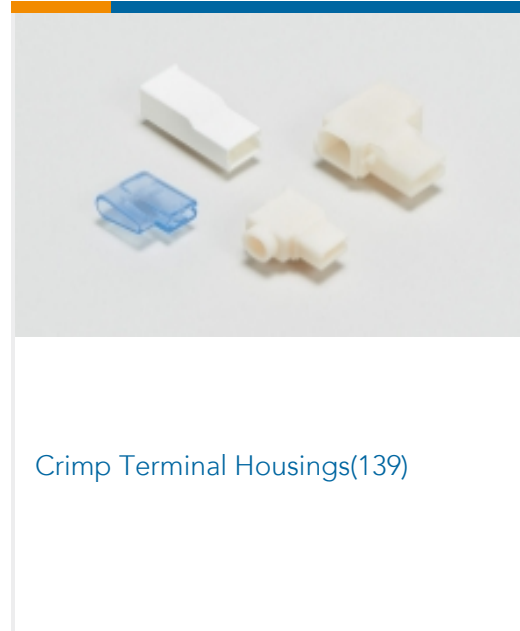

Crimp Terminal Housings(139)

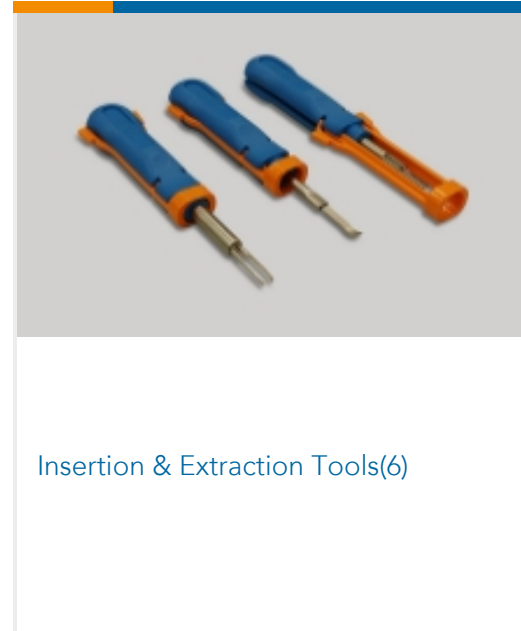

Insertion & Extraction Tools(6)



Magnet Wire Terminals(1)

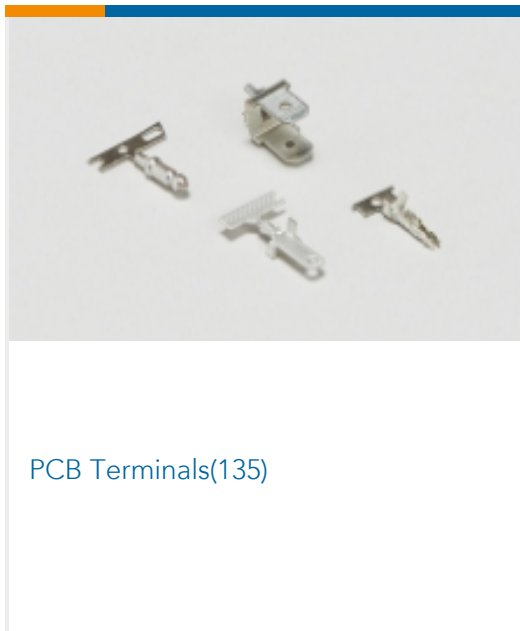

PCB Terminals(135)

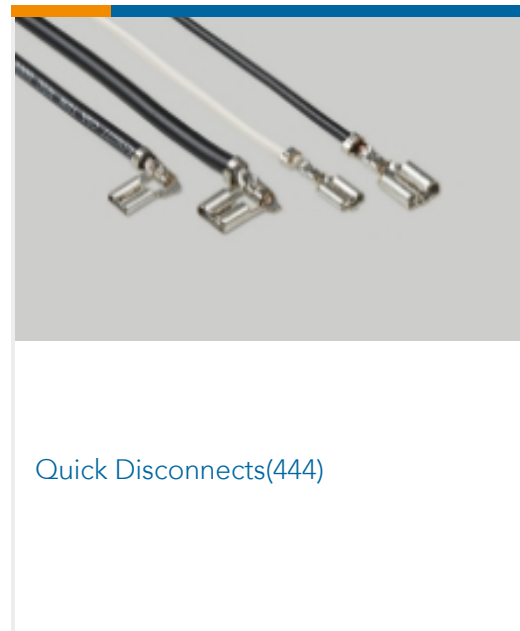

Quick Disconnects(444)



Splices(4)

Customers Also Bought

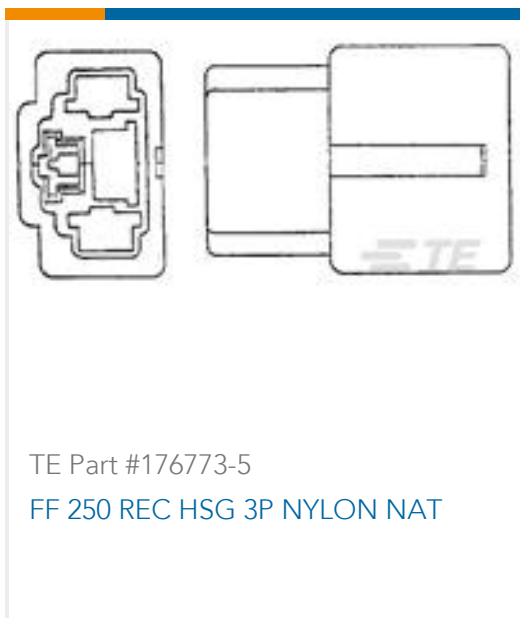

TE Part #176773-5
FF 250 REC HSG 3P NYLON NAT



TE Part #1-176497-1
250 HSG. PL EX FLAG REC. NAT



TE Part #170224-2
250 FASTON,REC.,16-10 AWG,BR



TE Part #179974-1
250 PL EX REC. 18-14AWG PTBR

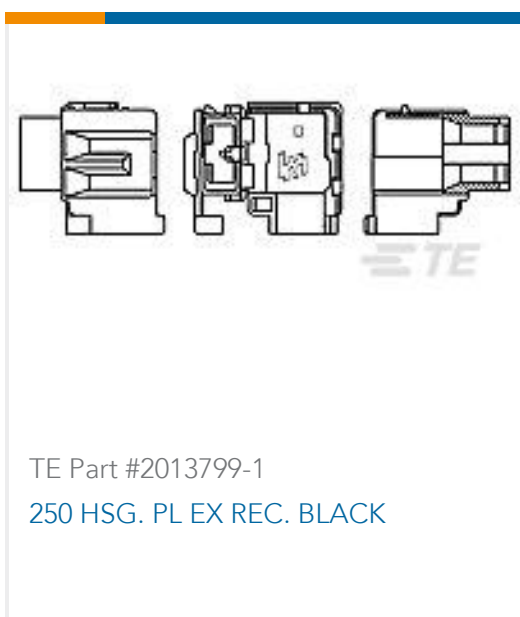

TE Part #2013799-1
250 HSG. PL EX REC. BLACK

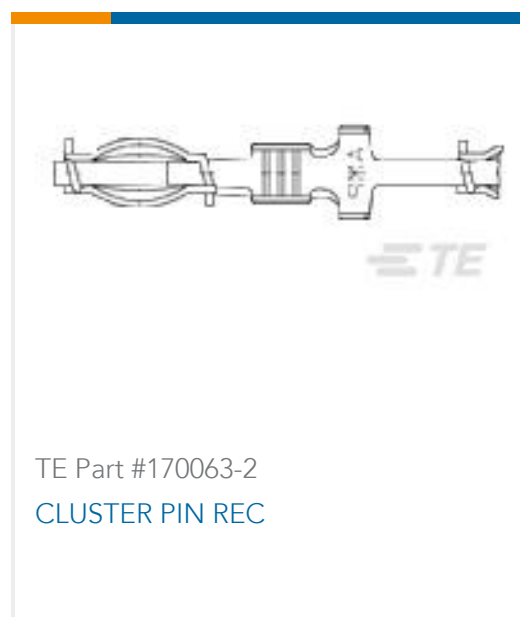

TE Part #170063-2
CLUSTER PIN REC



TE Part #913699-1
BLADE SHEAR



TE Part #2119659-1
PIN, FEED FINGER

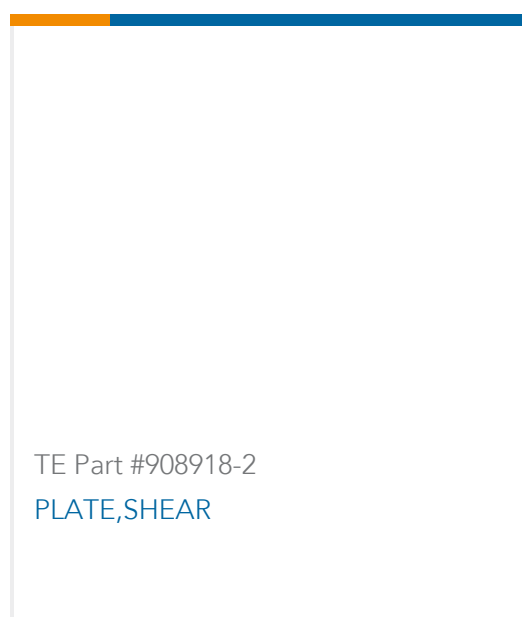

Documents

Product Drawings

[250 FASTON FLAG REC 18-12 AWG TPBR](#)

English

CAD Files

[3D PDF](#)

3D

Customer View Model

[ENG_CVM_CVM_41802_AP_c-41802-ap.2d_dxf.zip](#)

English

Customer View Model

[ENG_CVM_CVM_41802_AP_c-41802-ap.3d_igs.zip](#)

English

Customer View Model

[ENG_CVM_CVM_41802_AP_c-41802-ap.3d_stp.zip](#)

English

By downloading the CAD file I accept and agree to the [Terms and Conditions](#) of use.

Datasheets & Catalog Pages

[1654742_HOUSEHOLD_APPLIANCES_RAST5](#)

English

[82004 FASTON Terminals \(Insulated and Uninsulated\) Catalog - FASTON Receptacles Section](#)

English

[White Paper: Discolored Terminals Testing \(Effect of Testing on Discolored Terminals\)](#)

English

[White Paper: Salt Spray Testing \(Effect of Salt Spray Testing on Terminals\)](#)

English

Product Specifications

[Application Specification](#)

English

Product Environmental Compliance

[MD_41802_05312018952_dmtec](#)

English

[MD_41802_05312018952_dmtec](#)



English

[Agency Approvals](#)

[Agency Approval Document](#)

English

[Agency Approval Document](#)

English