

PLC-RSC- 24DC/21 - Relay Module



2966171

<https://www.phoenixcontact.com/za/products/2966171>

Please be informed that the data shown in this PDF document is generated from our online catalog. Please find the complete data in the user documentation. Our general terms of use for downloads are valid.



PLC-INTERFACE, consisting of basic terminal block PLC-BSC.../21 with screw connection and plug-in miniature relay with power contact, for assembly on DIN rail NS 35/7,5, 1 changeover contact, input voltage 24 V DC

Your advantages

- Slim design
- Efficient connection to system cabling using V8 adapter
- RT III sealed relay
- Safe isolation between coil and contact side
- Functional plug-in bridges
- Integrated input circuit and interference suppression circuit

Commercial data

Item number	2966171
Packing unit	10 pc
Minimum order quantity	1 pc
Sales key	062
Product key	CK621A
Catalog page	Page 364 (C-5-2019)
GTIN	4017918130732
Weight per piece (including packing)	39,8 g
Weight per piece (excluding packing)	31,06 g
Customs tariff number	85364190
Country of origin	DE

PLC-RSC- 24DC/21 - Relay Module



2966171

<https://www.phoenixcontact.com/za/products/2966171>

Technical data

Notes

General	Separating plate PLC-ATP must be installed for voltages larger than 250 V (L1, L2, L3) between identical terminal blocks in adjacent modules. Potential bridging is then carried out with FBST 8-PLC... or FBST 500....
---------	---

Product properties

Product type	Relay Module
Product family	PLC-INTERFACE
Application	Universal
Operating mode	100% operating factor
Mechanical service life	2x 10 ⁷ cycles

Electrical properties

Maximum power dissipation for nominal condition	0.22 W
Test voltage (Winding/contact)	4 kV AC (50 Hz, 1 min., winding/contact)

Insulation characteristics: Coil/contact

Rated insulation voltage	250 V
Rated impulse withstand voltage	6 kV
Overvoltage category	III
Degree of pollution	3

Input data

Coil side

Nominal input voltage U_N	24 V DC
Input voltage range	18.5 V DC ... 33.6 V DC (20 °C)
Drive and function	monostable
Drive (polarity)	polarized
Typical input current at U_N	9 mA
Typical response time	5 ms
Typical release time	8 ms
Protective circuit	Reverse polarity protection; Polarity protection diode Freewheeling diode; Freewheeling diode
Operating voltage display	Yellow LED

Output data

Switching

Contact switching type	1 changeover contact
Type of switch contact	Single contact
Contact connection type	Power contact
Contact material	AgSnO

PLC-RSC- 24DC/21 - Relay Module



2966171

<https://www.phoenixcontact.com/za/products/2966171>

Maximum switching voltage	250 V AC/DC (The separating plate PLC-ATP should be installed for voltages larger than 250 V (L1, L2, L3) between identical terminal blocks in adjacent modules. Potential bridging is then carried out with FBST 8-PLC... or ...FBST 500...)
Minimum switching voltage	5 V (100 mA)
Limiting continuous current	6 A
Maximum inrush current	10 A (4 s)
Min. switching current	10 mA (12 V)
Short-circuit current	200 A (conditional short-circuit current)
Interrupting rating (ohmic load) max.	140 W (at 24 V DC) 20 W (at 48 V DC) 18 W (at 60 V DC) 23 W (at 110 V DC) 40 W (at 220 V DC) 1500 VA (for 250 V AC)
Output fuse	4 A gL/gG NEOZED
Switching capacity	2 A (at 24 V, DC13) 0.2 A (at 110 V, DC13) 0.1 A (at 220 V, DC13) 3 A (at 24 V, AC15) 3 A (at 120 V, AC15) 3 A (at 230 V, AC15)

Connection data

Connection method	Screw connection
Stripping length	8 mm
Screw thread	M3
Conductor cross section rigid	0.14 mm ² ... 2.5 mm ²
Conductor cross section flexible	0.14 mm ² ... 2.5 mm ² 0.2 mm ² ... 2.5 mm ² (Single ferrule) 2x 0.5 mm ² ... 1.5 mm ² (TWIN ferrule)
Conductor cross section AWG	26 ... 14
Tightening torque	0.6 Nm ... 0.8 Nm

Dimensions

Width	6.2 mm
Height	80 mm
Depth	94 mm

Material specifications

Flammability rating according to UL 94	V0 (Housing)
--	--------------

Environmental and real-life conditions

Ambient conditions

Degree of protection (Relay)	RT III (Relay)
------------------------------	----------------

PLC-RSC- 24DC/21 - Relay Module



2966171

<https://www.phoenixcontact.com/za/products/2966171>

Degree of protection (Relay base)	IP20 (Relay base)
Degree of protection (Installation location)	≥ IP54 (Installation location)
Ambient temperature (operation)	-40 °C ... 70 °C (see to derating)
Ambient temperature (storage/transport)	-40 °C ... 85 °C

Approvals

CE

Certificate	CE-compliant
-------------	--------------

UKCA

Certificate	UKCA-compliant
-------------	----------------

Shipbuilding approval

Certificate	TAE0000196
-------------	------------

Corrosive gas test

Identification	ISA-S71.04. G3 Harsh Group
	EN 60068-2-60

DNV GL data

Temperature	D
Humidity	A
Vibration	B/C
EMC	B
Enclosure	Required protection according to the Rules shall be provided upon installation on board

EMC data

Low Voltage Directive	Conformance with Low Voltage Directive
Electromagnetic compatibility	Conformance with EMC directive

Standards and regulations

Standards/regulations	IEC 60947-5-1
-----------------------	---------------

Mounting

Mounting type	DIN rail mounting
Assembly instructions	in rows with zero spacing
Mounting position	any

Drawings

Diagram

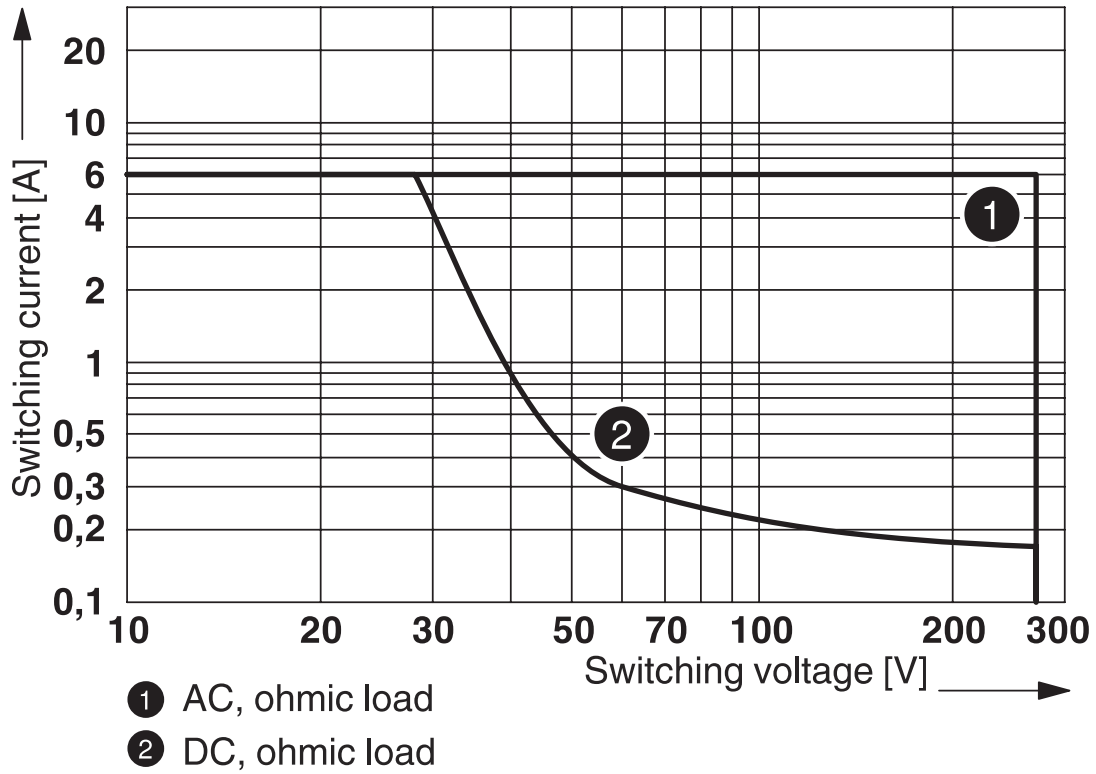

Interrupting rating

2966171

<https://www.phoenixcontact.com/za/products/2966171>

Diagram

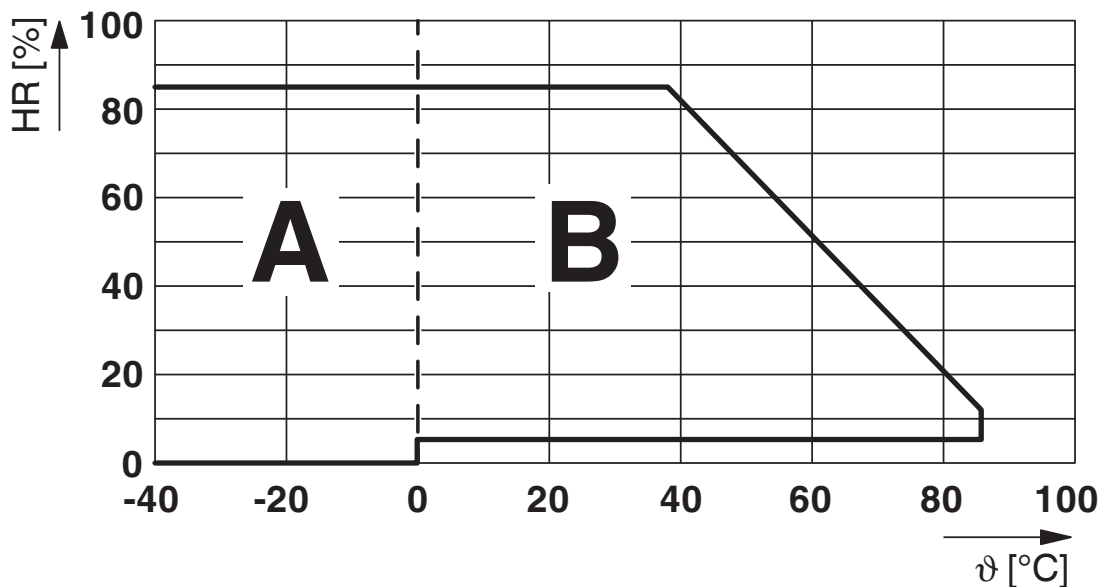

Permissible humidity for operation and storage.

The maximum permissible ambient temperature as specified in the data sheet must be observed.

Area A: Ice buildup at ambient temperatures $\leq 0^\circ\text{C}$ must be prevented

Area B: Condensation at ambient temperatures $> 0^\circ\text{C}$ must be prevented

On 30 full days that are naturally distributed across an entire year, a humidity level of 95% is permissible at an ambient temperature $\leq 25^\circ\text{C}$.

Circuit diagram

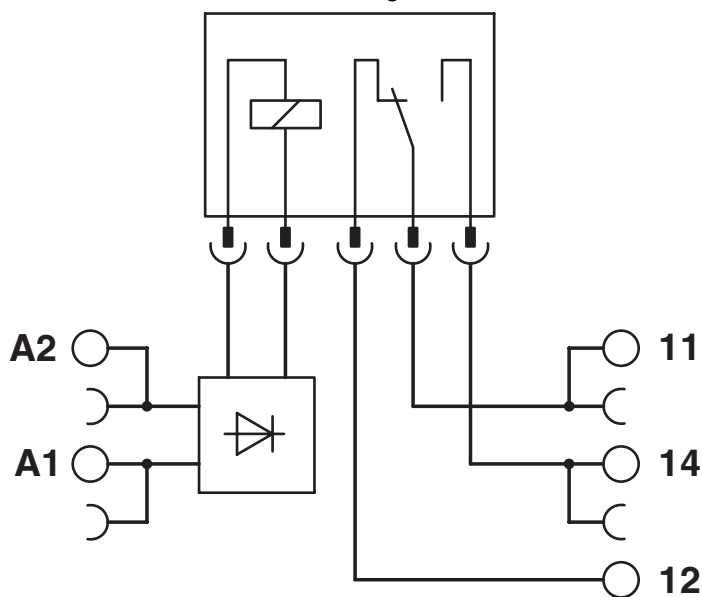

Diagram

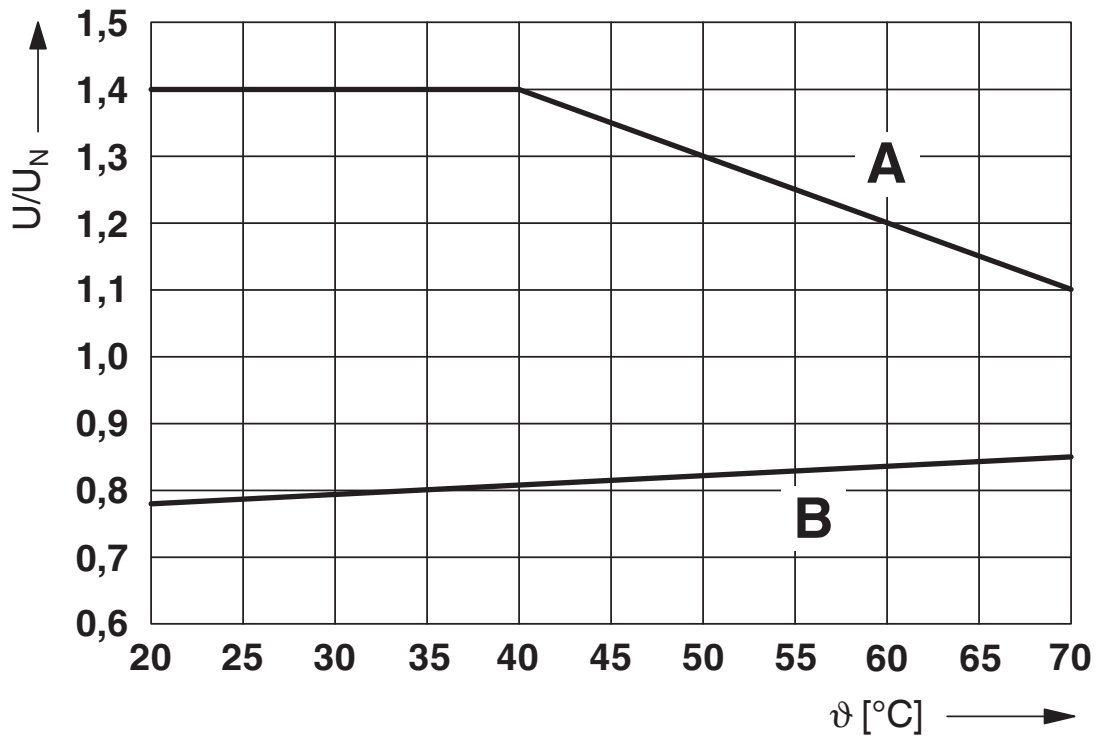

Curve A

Maximum permissible continuous voltage U_{\max} with limiting continuous current on the contact side (see relevant technical data)

Curve B

Minimum permissible operate voltage U_{op} after pre-excitation (see relevant technical data)

Diagram

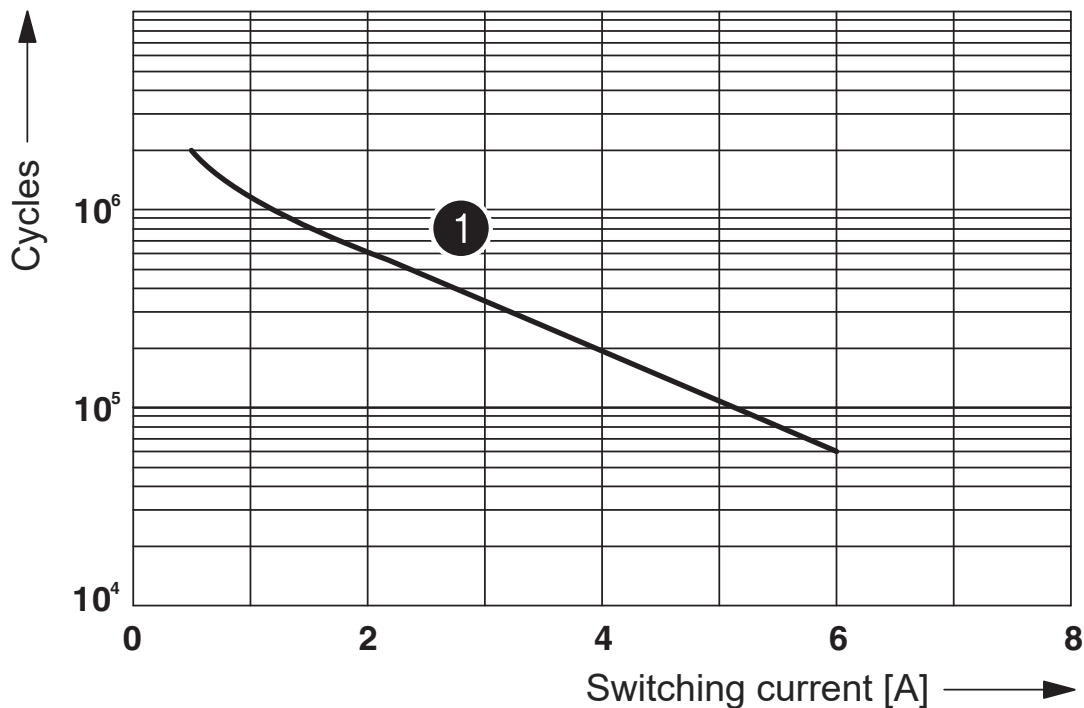

① 250 V AC, ohmic load

Electrical service life

Diagram

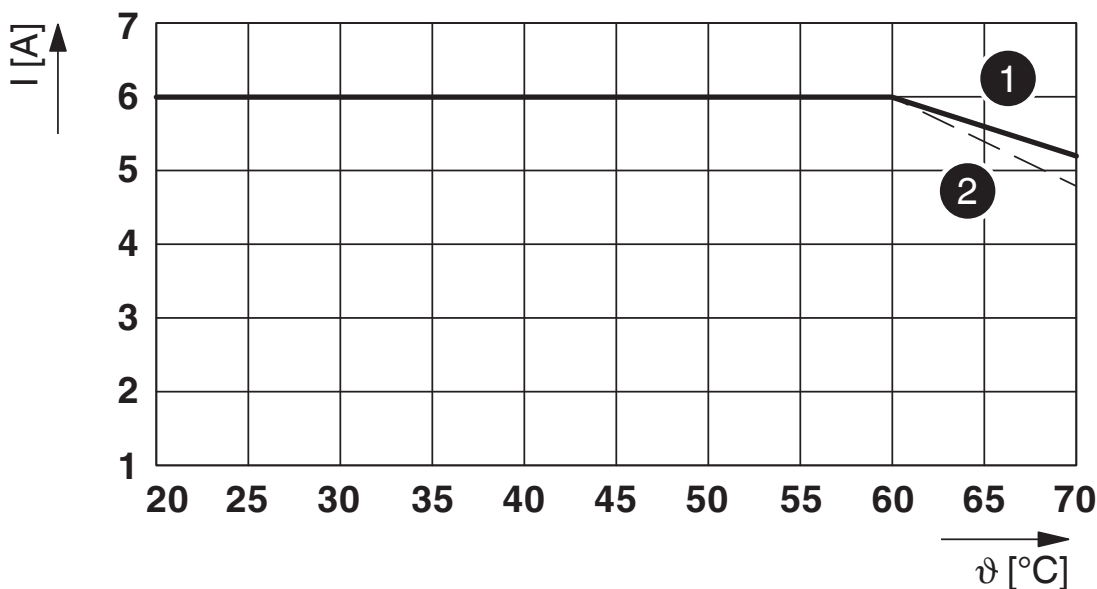

Limiting continuous current per contact for 0.85 ... 1.1 U_N (contact-side)

- (1) Limiting continuous current for horizontal installation position without clearance
- (2) Limiting continuous current for vertical installation position without clearance

PLC-RSC- 24DC/21 - Relay Module



2966171

<https://www.phoenixcontact.com/za/products/2966171>

Approvals

To download certificates, visit the product detail page: <https://www.phoenixcontact.com/za/products/2966171>



cUL Recognized
Approval ID: FILE E 238705



UL Recognized
Approval ID: FILE E 238705



EAC
Approval ID: TR_TS_D_00573_c



DNV GL
Approval ID: TAE0000196



EAC
Approval ID: RU*C-DE.*08.B.00010



UL Listed
Approval ID: FILE E 172140



cUL Listed
Approval ID: FILE E 172140

cULus Recognized

cULus Listed

PLC-RSC- 24DC/21 - Relay Module



2966171

<https://www.phoenixcontact.com/za/products/2966171>

Classifications

ECLASS

ECLASS-11.0	27371601
ECLASS-12.0	27371601
ECLASS-13.0	27371601

ETIM

ETIM 9.0	EC001437
----------	----------

UNSPSC

UNSPSC 21.0	39122300
-------------	----------

PLC-RSC- 24DC/21 - Relay Module



2966171

<https://www.phoenixcontact.com/za/products/2966171>

Environmental product compliance

REACH SVHC	Lead 7439-92-1
	Hexahydromethylphthalic anhydride
China RoHS	Environmentally Friendly Use Period = 50 years
	For information on hazardous substances, refer to the manufacturer's declaration available under "Downloads"

PLC-RSC- 24DC/21 - Relay Module

2966171

<https://www.phoenixcontact.com/za/products/2966171>

Accessories

 Note: Applying some accessories below might limit this product.

FBST 500-PLC RD - Continuous plug-in bridge

2966786

<https://www.phoenixcontact.com/za/products/2966786>



Continuous plug-in bridge, length: 500 mm, color: red

 Max. current carrying capacity: 32 A

FBST 500-PLC BU - Continuous plug-in bridge

2966692

<https://www.phoenixcontact.com/za/products/2966692>

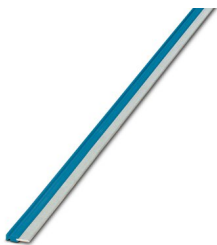

Continuous plug-in bridge, length: 500 mm, color: blue

 Max. current carrying capacity: 32 A

PLC-RSC- 24DC/21 - Relay Module

2966171

<https://www.phoenixcontact.com/za/products/2966171>



FBST 500-PLC GY - Continuous plug-in bridge

2966838

<https://www.phoenixcontact.com/za/products/2966838>



Continuous plug-in bridge, length: 500 mm, color: gray

 Max. current carrying capacity: 32 A

FBST 6-PLC RD - Single plug-in bridge

2966236

<https://www.phoenixcontact.com/za/products/2966236>

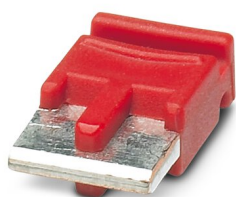

Single plug-in bridge, number of positions: 2, length: 6 mm, color: red

 Max. current carrying capacity: 6 A

PLC-RSC- 24DC/21 - Relay Module

2966171

<https://www.phoenixcontact.com/za/products/2966171>

FBST 6-PLC BU - Single plug-in bridge

2966812

<https://www.phoenixcontact.com/za/products/2966812>

Single plug-in bridge, number of positions: 2, length: 6 mm, color: blue

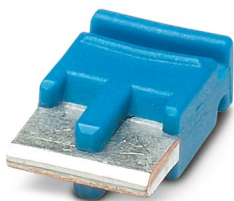

 Max. current carrying capacity: 6 A

FBST 6-PLC GY - Single plug-in bridge

2966825

<https://www.phoenixcontact.com/za/products/2966825>

Single plug-in bridge, number of positions: 2, length: 6 mm, color: gray

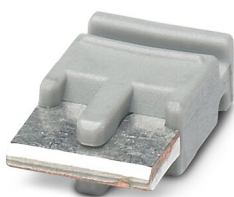

 Max. current carrying capacity: 6 A

PLC-RSC- 24DC/21 - Relay Module

2966171

<https://www.phoenixcontact.com/za/products/2966171>



FBST 8-PLC GY - Single plug-in bridge

2967688

<https://www.phoenixcontact.com/za/products/2967688>

Single plug-in bridge, number of positions: 2, length: 8 mm, color: gray



 Max. current carrying capacity: 6 A

PLC-V8/FLK14/OUT - System connection

2295554

<https://www.phoenixcontact.com/za/products/2295554>



V8 adapter for 8 x PLC-INTERFACE (6.2 mm), controller: PLC system cabling of output cards, connection 1: IDC/FLK pin strip 1x 14-position, connection 2: Plug-in connection (Can be snapped onto 8x PLC-INTERFACE terminals), connection 3: Screw connection 1x 2-position, number of channels: 8, control logic: plusschaltend

PLC-RSC- 24DC/21 - Relay Module

2966171

<https://www.phoenixcontact.com/za/products/2966171>

PLC-V8/FLK14/OUT/M - System connection

2304102

<https://www.phoenixcontact.com/za/products/2304102>



V8 adapter for 8 x PLC-INTERFACE (6.2 mm), controller: PLC system cabling of output cards, connection 1: IDC/FLK pin strip 1x 14-position, connection 2: Plug-in connection (Can be snapped onto 8x PLC-INTERFACE terminals), connection 3: Screw connection 1x 2-position, number of channels: 8, control logic: minusschaltend

PLC-V8/D15S/OUT - System connection

2296058

<https://www.phoenixcontact.com/za/products/2296058>



V8 adapter for 8 x PLC-INTERFACE (6.2 mm), controller: PLC system cabling of output cards, connection 1: D-SUB pin strip 1x 15-position, connection 2: Plug-in connection (Can be snapped onto 8x PLC-INTERFACE terminals), connection 3: Screw connection 1x 2-position, number of channels: 8, control logic: plusschaltend

PLC-RSC- 24DC/21 - Relay Module

2966171

<https://www.phoenixcontact.com/za/products/2966171>



PLC-V8/D15B/OUT - System connection

2296061

<https://www.phoenixcontact.com/za/products/2296061>



V8 adapter for 8 x PLC-INTERFACE (6.2 mm), controller: PLC system cabling of output cards, connection 1: D-SUB socket strip 1x 15-position, connection 2: Plug-in connection (Can be snapped onto 8x PLC-INTERFACE terminals), connection 3: Screw connection 1x 2-position, number of channels: 8, control logic: plusschaltend

PLC-FA-5X20 - Fuse adapter

1186510

<https://www.phoenixcontact.com/za/products/1186510>



Safety plug adapter for use on a 6.2 mm PLC basic terminal block. For 5 x 20 mm fuses. Operating voltage: Universal. Without fuse failure indication.

PLC-RSC- 24DC/21 - Relay Module

2966171

<https://www.phoenixcontact.com/za/products/2966171>



PLC-FA-I-5X20-12-24UC - Fuse adapter

1186499

<https://www.phoenixcontact.com/za/products/1186499>



Safety plug adapter for use on a 6.2 mm PLC basic terminal block. For 5 x 20 mm fuses. Operating voltage: 12 ... 24 V AC/DC. With LED for fuse failure indication.

PLC-FA-I-5X20-120-230UC - Fuse adapter

1186508

<https://www.phoenixcontact.com/za/products/1186508>



Safety plug adapter for use on a 6.2 mm PLC basic terminal block. For 5 x 20 mm fuses. Operating voltage: 120 ... 230 V AC/DC. With LED for fuse failure indication.

PLC-RSC- 24DC/21 - Relay Module

2966171

<https://www.phoenixcontact.com/za/products/2966171>



PLC-V8C/PT-24DC/RS485 - Controller

1452919

<https://www.phoenixcontact.com/za/products/1452919>



PLC logic basic module with RS-485 connection for Modbus/RTU communication, with 16 I/Os, for plug-in connection to 8 digital or analog PLC-INTERFACE terminal blocks, can be extended to 48 I/Os, real-time clock, micro USB female connector, accommodates memory module and Bluetooth adapter, Push-in connection

PLC-V8C/SC-24DC/EM - Extension module

2903095

<https://www.phoenixcontact.com/za/products/2903095>



PLC logic extension module with 16 I/Os, for plug-in connection to eight PLC-INTERFACE terminal blocks for extending the basic module (a maximum of two extension modules can be connected to a basic module), screw connection

PLC-RSC- 24DC/21 - Relay Module

2966171

<https://www.phoenixcontact.com/za/products/2966171>



PLC-V8C/PT-24DC/EM - Extension module

2905137

<https://www.phoenixcontact.com/za/products/2905137>



PLC logic extension module with 16 I/Os, for plug-in connection to eight PLC-INTERFACE terminal blocks for extending the basic module (a maximum of two extension modules can be connected to a basic module), Push-in connection

PLC-V8C/PT-24DC/SAM2 - Controller

2907443

<https://www.phoenixcontact.com/za/products/2907443>



PLC logic stand-alone module, Generation 2, with 16 I/Os, for plug-in connection to eight digital or analog PLC-INTERFACE terminal blocks, cannot be extended, real-time clock, micro USB female connector, accommodates memory module and Bluetooth adapter, Push-in connection

PLC-RSC- 24DC/21 - Relay Module

2966171

<https://www.phoenixcontact.com/za/products/2966171>



PLC-V8C/SC-24DC/SAM2 - Controller

2907445

<https://www.phoenixcontact.com/za/products/2907445>



PLC logic stand-alone module, Generation 2, with 16 I/Os, for plug-in connection to eight digital or analog PLC-INTERFACE terminal blocks, cannot be extended, real-time clock, micro USB female connector, accommodates memory module and Bluetooth adapter, screw connection

PLC-V8C/PT-24DC/BM2 - Controller

2907446

<https://www.phoenixcontact.com/za/products/2907446>



PLC logic basic module, Generation 2, with 16 I/Os, for plug-in connection to eight digital or analog PLC-INTERFACE terminal blocks, can be extended to 48 I/Os, real-time clock, micro USB female connector, accommodates memory module and Bluetooth adapter, Push-in connection

PLC-RSC- 24DC/21 - Relay Module

2966171

<https://www.phoenixcontact.com/za/products/2966171>



PLC-V8C/SC-24DC/BM2 - Controller

2907447

<https://www.phoenixcontact.com/za/products/2907447>

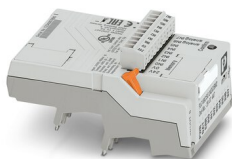

PLC logic basic module, Generation 2, with 16 I/Os, for plug-in connection to eight digital or analog PLC-INTERFACE terminal blocks, can be extended to 48 I/Os, real-time clock, micro USB female connector, accommodates memory module and Bluetooth adapter, screw connection

ZB 6:UNBEDRUCKT - Zack marker strip

1051003

<https://www.phoenixcontact.com/za/products/1051003>



Zack marker strip, Strip, white, unlabeled, can be labeled with: PLOTMARK, CMS-P1-PLOTTER, mounting type: snapped, for terminal block width: 6.2 mm, lettering field size: 6.15 x 10.5 mm, Number of individual labels: 10

PLC-RSC- 24DC/21 - Relay Module

2966171

<https://www.phoenixcontact.com/za/products/2966171>

ZB 6 CUS - Zack marker strip

0824992

<https://www.phoenixcontact.com/za/products/0824992>



Zack marker strip, can be ordered: Strip, white, labeled according to customer specifications, mounting type: snap into tall marker groove, for terminal block width: 6.2 mm, lettering field size: 6.15 x 10.5 mm, Number of individual labels: 10

ZB 6,LGS:FORTL.ZAHLEN - Zack marker strip

1051016

<https://www.phoenixcontact.com/za/products/1051016>



Zack marker strip, Strip, white, labeled, can be labeled with: CMS-P1-PLOTTER, printed horizontally: consecutive numbers 1 ... 10, 11 ... 20, etc. up to 491 ... 500, mounting type: snapped, for terminal block width: 6.2 mm, lettering field size: 6.15 x 10.5 mm, Number of individual labels: 10

PLC-RSC- 24DC/21 - Relay Module

2966171

<https://www.phoenixcontact.com/za/products/2966171>

ZB 6,QR:FORTL.ZAHLEN - Zack marker strip

1051029

<https://www.phoenixcontact.com/za/products/1051029>

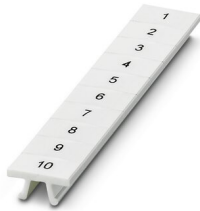

Zack marker strip, Strip, white, labeled, can be labeled with: CMS-P1-PLOTTER, Printed vertically: consecutive numbers 1 ... 10, 11 ... 20, etc. up to 491 ... 500, mounting type: snapped, for terminal block width: 6.2 mm, lettering field size: 6.15 x 10.5 mm, Number of individual labels: 10

ZB 6,LGS:GLEICHE ZAHLEN - Zack marker strip

1051032

<https://www.phoenixcontact.com/za/products/1051032>



Zack marker strip, Strip, white, labeled, can be labeled with: CMS-P1-PLOTTER, printed horizontally: Identical numbers 1 or 2, etc. up to 100, mounting type: snapped, for terminal block width: 6.2 mm, lettering field size: 6.15 x 10.5 mm, Number of individual labels: 10

PLC-RSC- 24DC/21 - Relay Module

2966171

<https://www.phoenixcontact.com/za/products/2966171>

ZB 6,LGS:L1-N,PE - Marker for terminal blocks

1051414

<https://www.phoenixcontact.com/za/products/1051414>



Marker for terminal blocks, Strip, white, labeled, can be labeled with: CMS-P1-PLOTTER, horizontal: L1, L2, L3, N, PE, L1, L2, L3, N, PE, mounting type: snapped, for terminal block width: 6.2 mm, lettering field size: 6.15 x 10.5 mm, Number of individual labels: 10

ZB 6,LGS:U-N - Marker for terminal blocks

1051430

<https://www.phoenixcontact.com/za/products/1051430>



Marker for terminal blocks, Strip, white, labeled, can be labeled with: CMS-P1-PLOTTER, printed horizontally: U, V, W, N, GND, U, V, W, N, GND, mounting type: snapped, for terminal block width: 6.2 mm, lettering field size: 6.15 x 10.5 mm, Number of individual labels: 10

PLC-RSC- 24DC/21 - Relay Module



2966171

<https://www.phoenixcontact.com/za/products/2966171>

UC-TM 6 - Marker for terminal blocks

0818085

<https://www.phoenixcontact.com/za/products/0818085>



Marker for terminal blocks, Sheet, white, unlabeled, can be labeled with: BLUEMARK ID COLOR, BLUEMARK ID, BLUEMARK CLED, PLOTMARK, CMS-P1-PLOTTER, mounting type: snapped, for terminal block width: 6.2 mm, lettering field size: 5.6 x 10.5 mm, Number of individual labels: 80

UC-TM 6 CUS - Marker for terminal blocks

0824589

<https://www.phoenixcontact.com/za/products/0824589>



Marker for terminal blocks, can be ordered: by sheet, white, labeled according to customer specifications, mounting type: snap into tall marker groove, for terminal block width: 6.2 mm, lettering field size: 5.6 x 10.5 mm, Number of individual labels: 80

PLC-RSC- 24DC/21 - Relay Module

2966171

<https://www.phoenixcontact.com/za/products/2966171>

UCT-TM 6 - Marker for terminal blocks

0828736

<https://www.phoenixcontact.com/za/products/0828736>



Marker for terminal blocks, Sheet, white, unlabeled, can be labeled with: TOPMARK NEO, TOPMARK LASER, BLUEMARK ID COLOR, BLUEMARK ID, BLUEMARK CLED, THERMOMARK PRIME, THERMOMARK CARD 2.0, THERMOMARK CARD, mounting type: snapped, for terminal block width: 6.2 mm, lettering field size: 5.6 x 10.5 mm, Number of individual labels: 60

UCT-TM 6 CUS - Marker for terminal blocks

0829602

<https://www.phoenixcontact.com/za/products/0829602>



Marker for terminal blocks, can be ordered: by sheet, white, labeled according to customer specifications, mounting type: snap into tall marker groove, for terminal block width: 6.2 mm, lettering field size: 5.6 x 10.5 mm, Number of individual labels: 60

PLC-RSC- 24DC/21 - Relay Module

2966171

<https://www.phoenixcontact.com/za/products/2966171>



NS 35/ 7,5 PERF 2000MM - DIN rail perforated

0801733

<https://www.phoenixcontact.com/za/products/0801733>



DIN rail perforated, Pack of 25 (50 m), acc. to EN 60715, material: Steel, galvanized, passivated with a thick layer, Standard profile, color: silver

NS 35/ 7,5 UNPERF 2000MM - DIN rail, unperforated

0801681

<https://www.phoenixcontact.com/za/products/0801681>



DIN rail, unperforated, Pack of 25 (50 m), acc. to EN 60715, material: Steel, galvanized, passivated with a thick layer, Standard profile, color: silver

PLC-RSC- 24DC/21 - Relay Module

2966171

<https://www.phoenixcontact.com/za/products/2966171>



NS 35/ 7,5 WH PERF 2000MM - DIN rail perforated

1204119

<https://www.phoenixcontact.com/za/products/1204119>



DIN rail perforated, Pack of 25 (50 m), acc. to EN 60715, material: Steel, Galvanized, white passivated, Standard profile, color: silver

NS 35/ 7,5 WH UNPERF 2000MM-VPE 10 - DIN rail, unperforated

1204122

<https://www.phoenixcontact.com/za/products/1204122>



DIN rail, unperforated, Pack of 10 (20 m), acc. to EN 60715, material: Steel, Galvanized, white passivated, Standard profile, color: silver

PLC-RSC- 24DC/21 - Relay Module

2966171

<https://www.phoenixcontact.com/za/products/2966171>



NS 35/ 7,5 AL UNPERF 2000MM - DIN rail, unperforated

0801704

<https://www.phoenixcontact.com/za/products/0801704>



DIN rail, unperforated, Pack of 25 (50 m), acc. to EN 60715, material: Aluminum, uncoated, Standard profile, color: silver

NS 35/ 7,5 ZN PERF 2000MM - DIN rail perforated

1206421

<https://www.phoenixcontact.com/za/products/1206421>



DIN rail perforated, Pack of 25 (50 m), acc. to EN 60715, material: Steel, galvanized, Standard profile, color: silver

PLC-RSC- 24DC/21 - Relay Module

2966171

<https://www.phoenixcontact.com/za/products/2966171>



NS 35/ 7,5 ZN UNPERF 2000MM - DIN rail, unperforated

1206434

<https://www.phoenixcontact.com/za/products/1206434>



DIN rail, unperforated, Pack of 25 (50 m), acc. to EN 60715, material: Steel, galvanized, Standard profile, color: silver

NS 35/ 7,5 CU UNPERF 2000MM-VPE 10 - DIN rail, unperforated

0801762

<https://www.phoenixcontact.com/za/products/0801762>



DIN rail, unperforated, Pack of 10 (20 m), acc. to EN 60715, material: Copper, uncoated, Standard profile, color: copper-colored

PLC-RSC- 24DC/21 - Relay Module

2966171

<https://www.phoenixcontact.com/za/products/2966171>

NS 35/ 7,5 CAP - End cap

1206560

<https://www.phoenixcontact.com/za/products/1206560>

DIN rail end piece, for DIN rail NS 35/7.5



NS 35/15 PERF 2000MM - DIN rail perforated

1201730

<https://www.phoenixcontact.com/za/products/1201730>



DIN rail perforated, Pack of 25 (50 m), similar to EN 60715, material: Steel, galvanized, passivated with a thick layer, Standard profile, color: silver

PLC-RSC- 24DC/21 - Relay Module

2966171

<https://www.phoenixcontact.com/za/products/2966171>

NS 35/15 UNPERF 2000MM - DIN rail, unperforated

1201714

<https://www.phoenixcontact.com/za/products/1201714>



DIN rail, unperforated, Pack of 25 (50 m), similar to EN 60715, material: Steel, galvanized, passivated with a thick layer, Standard profile, color: silver

NS 35/15 WH PERF 2000MM - DIN rail perforated

0806602

<https://www.phoenixcontact.com/za/products/0806602>



DIN rail perforated, Pack of 25 (50 m), similar to EN 60715, material: Steel, Galvanized, white passivated, Standard profile, color: white

PLC-RSC- 24DC/21 - Relay Module

2966171

<https://www.phoenixcontact.com/za/products/2966171>

NS 35/15 WH UNPERF 2000MM-VPE 10 - DIN rail, unperforated

1204135

<https://www.phoenixcontact.com/za/products/1204135>



DIN rail, unperforated, Pack of 10 (20 m), similar to EN 60715, material: Steel, Galvanized, white passivated, Standard profile, color: silver

NS 35/15 AL UNPERF 2000MM - DIN rail, unperforated

1201756

<https://www.phoenixcontact.com/za/products/1201756>



DIN rail, unperforated, similar to EN 60715, material: Aluminum, uncoated, Standard profile, color: silver

PLC-RSC- 24DC/21 - Relay Module

2966171

<https://www.phoenixcontact.com/za/products/2966171>

NS 35/15 ZN PERF 2000MM - DIN rail perforated

1206599

<https://www.phoenixcontact.com/za/products/1206599>



DIN rail perforated, Pack of 25 (50 m), similar to EN 60715, material: Steel, galvanized, Standard profile, color: silver

NS 35/15 ZN UNPERF 2000MM - DIN rail, unperforated

1206586

<https://www.phoenixcontact.com/za/products/1206586>



DIN rail, unperforated, Pack of 25 (50 m), similar to EN 60715, material: Steel, galvanized, Standard profile, color: silver

PLC-RSC- 24DC/21 - Relay Module



2966171

<https://www.phoenixcontact.com/za/products/2966171>

NS 35/15 CU UNPERF 2000MM-VPE 10 - DIN rail, unperforated

1201895

<https://www.phoenixcontact.com/za/products/1201895>



DIN rail, unperforated, Pack of 10 (20 m), similar to EN 60715, material: Copper, uncoated, Standard profile, color: copper-colored

NS 35/15 CAP - End cap

1206573

<https://www.phoenixcontact.com/za/products/1206573>

DIN rail end piece, for DIN rail NS 35/15



PLC-RSC- 24DC/21 - Relay Module

2966171

<https://www.phoenixcontact.com/za/products/2966171>



NS 35/15-2,3 UNPERF 2000MM-VPE 10 - DIN rail, unperforated

1201798

<https://www.phoenixcontact.com/za/products/1201798>



DIN rail, unperforated, Pack of 10 (20 m), acc. to EN 60715, material: Steel, galvanized, passivated with a thick layer, Standard profile 2.3 mm, color: silver

PLC-ATP BK - Separating plate

2966841

<https://www.phoenixcontact.com/za/products/2966841>



Separating plate, 2 mm thick, required at the start and end of a PLC terminal strip. Furthermore, it is used for: visual separation of groups, safe isolation of different voltages of neighboring PLC relays in acc. with DIN VDE 0106-101, isolation

PLC-RSC- 24DC/21 - Relay Module

2966171

<https://www.phoenixcontact.com/za/products/2966171>



PLC-ESK GY - Power terminal block

2966508

<https://www.phoenixcontact.com/za/products/2966508>



Power terminal block, for the input of up to four potentials, for mounting on NS 35/7.5

SZF 1-0,6X3,5 - Screwdriver

1204517

<https://www.phoenixcontact.com/za/products/1204517>



Actuation tool, for ST terminal blocks, also suitable for use as a bladed screwdriver, size: 0.6 x 3.5 x 100 mm, 2-component grip, with non-slip grip

PLC-RSC- 24DC/21 - Relay Module

2966171

<https://www.phoenixcontact.com/za/products/2966171>



REL-MR- 24DC/21 - Single relay

2961105

<https://www.phoenixcontact.com/za/products/2961105>

Plug-in miniature power relay, with power contact, 1 changeover contact, input voltage 24 V DC

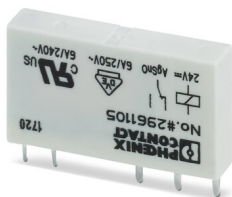

Phoenix Contact 2023 © - all rights reserved

<https://www.phoenixcontact.com>

PHOENIX CONTACT (Pty) Ltd.

36 Lyn Road P.O. Box 916 ZA-Ferndale 2160

+27/11/801-8200

info@phoenixcontact.co.za