

Installation Instructions

Original Instructions



Allen-Bradley

by ROCKWELL AUTOMATION

FLEX I/O-XT Digital DC Input/Output Modules

Catalog Numbers 1794-OB8EPXT, 1794-IB16XT, 1794-OB16PXT, 1794-IB10XOB6XT

Modules with an XT in the last position of the catalog number are conformally coated to meet noxious gas requirements of ISA/ANSI-71.040-1985 Class G3 Environment.

Topic	Page
Summary of Changes	1
Install Your Digital DC Input/Output Module	5
Configure Your Module	8
Specifications	11

Summary of Changes

This publication contains the following new or updated information. This list includes substantive updates only and is not intended to reflect all changes.

Description	Page
Updated template	throughout
Updated Environment and Enclosure	3
Updated Special Conditions for Safe Use	3
Updated UK and European Hazardous Location Approval	4
Updated IEC Hazardous Location Approval	4
Updated Specifications	11
Updated General Specifications	12
Updated Environmental Specifications	12
Updated Certifications	13



ATTENTION: Read this document and the documents listed in the Additional Resources section about installation, configuration and operation of this equipment before you install, configure, operate or maintain this product. Users are required to familiarize themselves with installation and wiring instructions in addition to requirements of all applicable codes, laws, and standards.

Activities including installation, adjustments, putting into service, use, assembly, disassembly, and maintenance are required to be carried out by suitably trained personnel in accordance with applicable code of practice. If this equipment is used in a manner not specified by the manufacturer, the protection provided by the equipment may be impaired.

注意: 在安装、配置、操作和维护本产品前, 请阅读本文档以及“其他资源”部分列出的有关设备安装、配置和操作的相应文档。除了所有适用规范、法律和标准的相关要求之外, 用户还必须熟悉安装和接线说明。

安装、调整、搬运、使用、组装、拆卸和维护等各项操作必须由经过适当训练的专业人员按照适用的操作规范实施。

如果未按照制造商指定的方式使用该设备, 则可能会损害设备提供的保护。

ATENCIÓN: Antes de instalar, configurar, poner en funcionamiento o realizar el mantenimiento de este producto, lea este documento y los documentos listados en la sección Recursos adicionales acerca de la instalación, configuración y operación de este equipo. Los usuarios deben familiarizarse con las instrucciones de instalación y cableado y con los requisitos de todos los códigos, leyes y estándares vigentes. El personal debidamente capacitado debe realizar las actividades relacionadas a la instalación, ajustes, puesta en servicio, uso, ensamblaje, desensamblaje y mantenimiento de conformidad con el código de práctica aplicable. Si este equipo se usa de una manera no especificada por el fabricante, la protección provista por el equipo puede resultar afectada.

ATENÇÃO: Leia este e os demais documentos sobre instalação, configuração e operação do equipamento que estão na seção Recursos adicionais antes de instalar, configurar, operar ou manter este produto. Os usuários devem se familiarizar com as instruções de instalação e fiação além das especificações para todos os códigos, leis e normas aplicáveis.

É necessário que as atividades, incluindo instalação, ajustes, colocação em serviço, utilização, montagem, desmontagem e manutenção sejam realizadas por pessoal qualificado e especializado, de acordo com o código de prática aplicável.

Caso este equipamento seja utilizado de maneira não estabelecida pelo fabricante, a proteção fornecida pelo equipamento pode ficar prejudicada.

ВНИМАНИЕ: Перед тем как устанавливать, настраивать, эксплуатировать или обслуживать данное оборудование, прочитайте этот документ и документы, перечисленные в разделе «Дополнительные ресурсы». В этих документах изложены сведения об установке, настройке и эксплуатации данного оборудования. Пользователи обязаны ознакомиться с инструкциями по установке и прокладке соединений, а также с требованиями всех применимых норм, законов и стандартов.

Все действия, включая установку, наладку, ввод в эксплуатацию, использование, сборку, разборку и техническое обслуживание, должны выполняться обученным персоналом в соответствии с применимыми нормами и правилами.

Если оборудование используется не предусмотренным производителем образом, защита оборудования может быть нарушена.

注意: 本製品を設置、構成、稼働または保守する前に、本書および本機器の設置、設定、操作についての参考資料の該当箇所に記載されている文書に目を通してください。ユーザは、すべての該当する条例、法律、規格の要件に加えて、設置および配線の手順に習熟している必要があります。

設置調整、運転の開始、使用、組立て、解体、保守を含む諸作業は、該当する実施規則に従って訓練を受けた適切な作業員が実行する必要があります。

本機器が製造メーカーにより指定されていない方法で使用されている場合、機器により提供されている保護が損なわれる恐れがあります。

ACHTUNG: Lesen Sie dieses Dokument und die im Abschnitt „Weitere Informationen“ aufgeführten Dokumente, die Informationen zur Installation, Konfiguration und Bedienung dieses Produkts enthalten, bevor Sie dieses Produkt installieren, konfigurieren, bedienen oder warten. Anwender müssen sich neben den Bestimmungen aller anwendbaren Vorschriften, Gesetze und Normen zusätzlich mit den Installations- und Verdrahtungsanweisungen vertraut machen.

Arbeiten im Rahmen der Installation, Anpassung, Inbetriebnahme, Verwendung, Montage, Demontage oder Instandhaltung dürfen nur durch ausreichend geschulte Mitarbeiter und in Übereinstimmung mit den anwendbaren Ausführungsvorschriften vorgenommen werden.

Wenn das Gerät in einer Weise verwendet wird, die vom Hersteller nicht vorgesehen ist, kann die Schutzfunktion beeinträchtigt sein.

ATTENTION : Lisez ce document et les documents listés dans la section Ressources complémentaires relatifs à l'installation, la configuration et le fonctionnement de cet équipement avant d'installer, configurer, utiliser ou entretenir ce produit. Les utilisateurs doivent se familiariser avec les instructions d'installation et de câblage en plus des exigences relatives aux codes, lois et normes en vigueur.

Les activités relatives à l'installation, le réglage, la mise en service, l'utilisation, l'assemblage, le démontage et l'entretien doivent être réalisées par des personnes formées selon le code de pratique en vigueur.

Si cet équipement est utilisé d'une façon qui n'a pas été définie par le fabricant, la protection fournie par l'équipement peut être compromise.

주의: 본 제품 설치, 설정, 작동 또는 유지 보수하기 전에 본 문서를 포함하여 설치, 설정 및 작동에 관한 참고 자료 섹션의 문서들을 반드시 읽고 숙지하십시오. 사용자는 모든 관련 규정, 법규 및 표준에서 요구하는 사항에 대해 반드시 설치 및 배선 지침을 숙지해야 합니다.

설치, 조정, 가동, 사용, 조립, 분해, 유지보수 등 모든 작업은 관련 규정에 따라 적절한 교육을 받은 사용자들 통해서만 수행해야 합니다.

본 장비를 제조사가 명시하지 않은 방법으로 사용하면 장비의 보호 기능이 손상될 수 있습니다.

ATTENZIONE Prima di installare, configurare ed utilizzare il prodotto, o effettuare interventi di manutenzione su di esso, leggere il presente documento ed i documenti elencati nella sezione "Altre risorse", riguardanti l'installazione, la configurazione ed il funzionamento dell'apparecchiatura. Gli utenti devono leggere e comprendere le istruzioni di installazione e cablaggio, oltre ai requisiti previsti dalle leggi, codici standard applicabili.

Le attività come installazione, regolazioni, utilizzo, assemblaggio, disassemblaggio e manutenzione devono essere svolte da personale adeguatamente addestrato, nel rispetto delle procedure previste.

Qualora l'apparecchio venga utilizzato con modalità diverse da quanto previsto dal produttore, la sua funzione di protezione potrebbe venire compromessa.

DİKKAT: Bu ürünün kurulumu, yapılandırılması, işletilmesi veya bakımı öncesinde bu dokümanı ve bu ekipmanın kurulumu, yapılandırılması ve işletimi ile ilgili ilave Kaynaklar bölümünde yer listelenmiş dokümanları okuyun. Kullanıcılar yürürlükteki tüm yönetmelikler, yasal ve standartların gereksinimlerine ek olarak kurulum ve kablolama talimatlarını da öğrenmek zorundadır.

Kurulum, ayarlama, hizmete alma, kullanma, parçaları birleştirme, parçaları sökme ve bakım gibi aktiviteler sadece uygun eğitimli almış kişiler tarafından yürürlükteki uygulama yönetmeliklerine uygun şekilde yapılabilir.

Bu ekipman üretici tarafından belirlenmiş amacın dışında kullanılırsa, ekipman tarafından sağlanan koruma bozulabilir.

注意事項: 在安装、設定、操作或維護本產品前, 請先閱讀此文件以及列於「其他資源」章節中有關安裝、設定與操作此設備的文件。使用者必須熟悉安裝和配線指示, 並符合所有法規、法律和標準要求。

包括安裝、調整、交付使用、使用、組裝、拆卸和維護等動作都必須交由已經適當訓練的人員進行, 以符合適用的實作法規。

如果將設備用於非製造商指定的用途時, 可能會造成設備所提供的保護功能受損。

POZOR: Než začnete instalovat, konfigurovat či provozovat tento výrobek nebo provádět jeho údržbu, přečtěte si tento dokument a dokumenty uvedené v části Dodatečné zdroje ohledně instalace, konfigurace a provozu tohoto zařízení. Uživatelé se musejí vedle požadavků všech relevantních vyhlášek, zákonů a norem nutně seznámit také s pokyny pro instalaci a elektrické zapojení.

Činnosti zahrnující instalaci, nastavení, uvedení do provozu, užívání, montáž, demontáž a údržbu musí vykonávat vhodné proškolený personál v souladu s příslušnými prováděcími předpisy.

Pokud se toto zařízení používá způsobem neodpovídajícím specifikaci výrobce, může být narušena ochrana, kterou toto zařízení poskytuje.

UWAGA: Przed instalacją, konfiguracją, użytkowaniem lub konserwacją tego produktu należy przeczytać niniejszy dokument oraz wszystkie dokumenty wymienione w sekcji Dodatkowe źródła omawiające instalację, konfigurację i procedury użytkowania tego urządzenia. Użytkownicy mają obowiązek zapoznać się z instrukcjami dotyczącymi instalacji oraz oprzewodowania, jak również z obowiązującymi kodeksami, prawem i normami.

Działania obejmujące instalację, regulację, przekazanie do użytkowania, użytkowanie, montaż, demontaż oraz konserwację muszą być wykonywane przez odpowiednio przeszkolony personel zgodnie z obowiązującym kodeksem postępowania.

Jeśli urządzenie jest użytkowane w sposób inny niż określony przez producenta, zabezpieczenie zapewniane przez urządzenie może zostać ograniczone.

ÖBS! Läs detta dokument samt dokumentet, som står listat i avsnittet Övriga resurser, om installation, konfigurering och drift av denna utrustning innan du installerar, konfigurerar eller börjar använda eller utföra underhållsarbete på produkten. Användare måste bekanta sig med instruktioner för installation och kabeldragning, förutom krav enligt gällande koder, lagar och standarder.

Åtgärder som installation, justering, service, användning, montering, demontering och underhållsarbete måste utföras av personal med lämplig utbildning enligt lämpligt bruk.

Om denna utrustning används på ett sätt som inte anges av tillverkaren kan det hända att utrustningens skyddsanordningar försätts ur funktion.

LET OP: Lees dit document en de documenten die genoemd worden in de paragraaf Aanvullende informatie over de installatie, configuratie en bediening van deze apparatuur voordat u dit product installeert, configureert, bedient of onderhoudt. Gebruikers moeten zich vertrouwd maken met de installatie en de bedringsinstructies, naast de vereisten van alle toepasselijke regels, wetten en normen.

Activiteiten zoals het installeren, afstellen, in gebruik stellen, gebruiken, monteren, demonteren en het uitvoeren van onderhoud mogen uitsluitend worden uitgevoerd door hiervoor opgeleid personeel en in overeenstemming met de geldende praktijkregels.

Indien de apparatuur wordt gebruikt op een wijze die niet is gespecificeerd door de fabrikant, dan bestaat het gevaar dat de beveiliging van de apparatuur niet goed werkt.

Environment and Enclosure



ATTENTION: This equipment is intended for use in a Pollution Degree 2 industrial environment, in overvoltage Category II applications (as defined in EN/IEC 60664-1), at altitudes up to 2000 m (6562 ft) without derating.

This equipment is not intended for use in residential environments and may not provide adequate protection to radio communication services in such environments.

This equipment is supplied as open-type equipment for indoor use. It must be mounted within an enclosure that is suitably designed for those specific environmental conditions that will be present and appropriately designed to prevent personal injury resulting from accessibility to live parts. The enclosure must have suitable flame-retardant properties to prevent or minimize the spread of flame, complying with a flame spread rating of 5VA or be approved for the application if nonmetallic. The interior of the enclosure must be accessible only by the use of a tool. Subsequent sections of this publication may contain more information regarding specific enclosure type ratings that are required to comply with certain product safety certifications.

In addition to this publication, see the following:

- Industrial Automation Wiring and Grounding Guidelines, publication [1770-4.1](#), for additional installation requirements.
- NEMA Standard 250 and IEC 60529, as applicable, for explanations of the degrees of protection provided by enclosures.



WARNING:

- When you insert or remove the module while backplane power is on, an electrical arc can occur. This could cause an explosion in hazardous location installations. Be sure that power is removed or the area is nonhazardous before proceeding.
- If you connect or disconnect wiring while the field-side power is on, an electrical arc can occur. This could cause an explosion in hazardous location installations. Be sure that power is removed or the area is nonhazardous before proceeding.



ATTENTION:

- This product is grounded through the DIN rail to chassis ground. Use zinc plated chromate-passivated steel DIN rail to assure proper grounding. The use of other DIN rail materials (for example, aluminum or plastic) that can corrode, oxidize, or are poor conductors, can result in improper or intermittent grounding. Secure DIN rail to mounting surface approximately every 200 mm (7.8 in.) and use end-anchors appropriately. Be sure to ground the DIN rail properly. See the Industrial Automation Wiring and Grounding Guidelines, Rockwell Automation publication [1770-4.1](#), for more information.
- Personnel responsible for the application of safety-related Programmable Electronic Systems (PES) shall be aware of the safety requirements in the application of the system and shall be trained in using the system.
- Do not remove or replace a Terminal Base unit while power is applied. Interruption of the backplane can result in unintentional operation or machine motion.

Prevent Electrostatic Discharge



ATTENTION: This equipment is sensitive to electrostatic discharge, which can cause internal damage and affect normal operation. Follow these guidelines when you handle this equipment:

- Touch a grounded object to discharge potential static.
- Wear an approved grounding wriststrap.
- Do not touch connectors or pins on component boards.
- Do not touch circuit components inside the equipment.
- Use a static-safe workstation, if available.
- Store the equipment in appropriate static-safe packaging when not in use.

Special Conditions for Safe Use



WARNING:

- This equipment is not resistant to sunlight or other sources of UV radiation.
- This equipment shall be mounted in an UKEX/ATEX/IECEx Zone 2 certified enclosure with a minimum ingress protection rating of at least IP54 (in accordance with EN/IEC 60079-0) and used in an environment of not more than Pollution Degree 2 (as defined in EN/IEC 60664-1) when applied in Zone 2 environments. The enclosure must be accessible only by the use of a tool.
- This equipment shall be used within its specified ratings defined by Rockwell Automation.
- Transient protection shall be provided that is set at a level not exceeding 140% of the peak rated voltage value at the supply terminals to the equipment.
- This equipment must be used only with UKEX/ATEX/IECEx certified Rockwell Automation backplanes.
- Secure any external connections that mate to this equipment by using screws, sliding latches, threaded connectors, or other means provided with this product.
- Do not disconnect equipment unless power has been removed or the area is known to be nonhazardous.
- Earthing is accomplished through mounting of modules on rail.

UK and European Hazardous Location Approval

The following output modules are UK and European Zone 2 approved: 1794-0B8EPXT, 1794-1B16XT, 1794-0B16PXT, and 1794-1B10X0B6XT.

The following applies to products marked II 3 G:

- Are Equipment Group II, Equipment Category 3, and comply with the Essential Health and Safety Requirements relating to the design and construction of such equipment given in Schedule 1 of UKEX and Annex II of EU Directive 2014/34/EU. See the UKEx and EU Declaration of Conformity at rok.auto/certifications for details.
- The type of protection is Ex ec IIC T4 Gc according to EN IEC 60079-0:2018, EXPLOSIVE ATMOSPHERES - PART 0: EQUIPMENT - GENERAL REQUIREMENTS, Issue Date 07/2018 and EN IEC 60079-7:2015+A1:2018, Explosive atmospheres. Equipment protection by increased safety "e".
- Comply to Standard EN IEC 60079-0:2018, EXPLOSIVE ATMOSPHERES - PART 0: EQUIPMENT - GENERAL REQUIREMENTS, Issue Date 07/2018, EN IEC 60079-7:2015+A1:2018 Explosive atmospheres. Equipment protection by increased safety "e", reference certificate number DEMKO 14 ATEX 1342501X and UL22UKEX2378X.
- Are intended for use in areas in which explosive atmospheres caused by gases, vapors, mists, or air are unlikely to occur, or are likely to occur only infrequently and for short periods. Such locations correspond to Zone 2 classification according to UKEX regulation 2016 No. 1107 and ATEX directive 2014/34/EU.



IEC Hazardous Location Approval

The following applies to products marked with IECEx certification:

- Are intended for use in areas in which explosive atmospheres caused by gases, vapors, mists, or air are unlikely to occur, or are likely to occur only infrequently and for short periods. Such locations correspond to Zone 2 classification to IEC 60079-0.
- The type of protection is Ex ec IIC T4 Gc according to IEC 60079-0 and IEC 60079-7.
- Comply to Standards IEC 60079-0, Explosive atmospheres Part 0: Equipment - General requirements, Edition 7, Revision Date 2017, IEC 60079-7, 5.1 Edition revision date 2017, Explosive atmospheres - Part 7: Equipment protection by increased safety "e", reference IECEx certificate number IECEx UL 14.0066X.

North American Hazardous Location Approval

The following output modules are North American Hazardous Location approved: 1794-0B8EPXT, 1794-1B16XT, 1794-0B16PXT, and 1794-1B10X0B6XT.

The following information applies when operating this equipment in hazardous locations.	Informations sur l'utilisation de cet équipement en environnements dangereux.
<p>Products marked "CL I, DIV 2, GP A, B, C, D" are suitable for use in Class I Division 2 Groups A, B, C, D, Hazardous Locations and nonhazardous locations only. Each product is supplied with markings on the rating nameplate indicating the hazardous location temperature code. When combining products within a system, the most adverse temperature code (lowest "T" number) may be used to help determine the overall temperature code of the system. Combinations of equipment in your system are subject to investigation by the local Authority Having Jurisdiction at the time of installation.</p>	<p>Les produits marqués "CL I, DIV 2, GP A, B, C, D" ne conviennent qu'à une utilisation en environnements de Classe I Division 2 Groupes A, B, C, D dangereux et non dangereux. Chaque produit est livré avec des marquages sur sa plaque d'identification qui indiquent le code de température pour les environnements dangereux. Lorsque plusieurs produits sont combinés dans un système, le code de température le plus défavorable (code de température le plus faible) peut être utilisé pour déterminer le code de température global du système. Les combinaisons d'équipements dans le système sont sujettes à inspection par les autori</p>
<div style="display: flex; align-items: center;">  <div> <p>WARNING: Explosion Hazard -</p> <ul style="list-style-type: none"> • Do not disconnect equipment unless power has been removed or the area is known to be nonhazardous. • Do not disconnect connections to this equipment unless power has been removed or the area is known to be nonhazardous. Secure any external connections that mate to this equipment by using screws, sliding latches, threaded connectors, or other means provided with this product. • Substitution of components may impair suitability for Class I, Division 2. • If this product contains batteries, they must only be changed in an area known to be nonhazardous. </div> </div>	<div style="display: flex; align-items: center;">  <div> <p>AVERTISSEMENT: Risque d'Explosion -</p> <ul style="list-style-type: none"> • Couper le courant ou s'assurer que l'environnement est classé non dangereux avant de débrancher l'équipement. • Couper le courant ou s'assurer que l'environnement est classé non dangereux avant de débrancher les connecteurs. Fixer tous les connecteurs externes reliés à cet équipement à l'aide de vis, loquets coulissants, connecteurs filetés ou autres moyens fournis avec ce produit. • La substitution de composants peut rendre cet équipement inadapté à une utilisation en environnement de Classe I, Division 2. • S'assurer que l'environnement est classé non dangereux avant de changer les piles. </div> </div>

Install Your Digital DC Input/Output Module

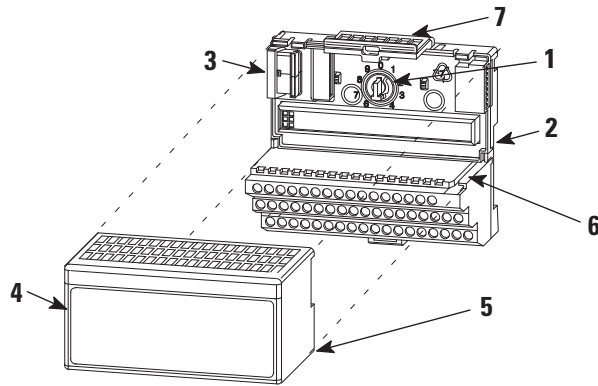

	Description		Description
1	Keyswitch	5	Alignment bar
2	Terminal base	6	Groove
3	Flexbus connector	7	Latching mechanism
4	Module		

The FLEX I/O-XT™ Digital DC Input/Output module mounts on a 1794 terminal base.



ATTENTION: During mounting of all devices, be sure that all debris (for example, metal chips and wire strands) is kept from falling into the module. Debris that falls into the module could cause damage on power up.

1. Rotate the keyswitch **(1)** on the terminal base **(2)** clockwise to position 2 as required for this type of module.
2. Make certain the Flexbus connector **(3)** is pushed all the way to the left to connect with the neighboring terminal base/adaptor. **You cannot install the module unless the connector is fully extended.**
3. Make sure the pins on the bottom of the module are straight so they will align properly with the connector in the terminal base.
4. Position the module **(4)** with its alignment bar **(5)** aligned with the groove **(6)** on the terminal base.
5. Press firmly and evenly to seat the module in the terminal base unit. The module is seated when the latching mechanism **(7)** is locked into the module.

Connect Wiring for the 1794-OB8EPXT, 1794-OB16PXT and 1794-IB10XOB6XT

1. Connect individual output wiring to numbered terminals on the 0...15 row as indicated in [Table 1 on page 6](#), [Table 2 on page 6](#), and [Table 4 on page 7](#) (1794-OB16P – terminals 0...15, 1794-OB8EPXT – even numbered terminals 0...14).
2. Connect the associated -V output common to the corresponding terminal on the 16...33 row (B) for each output as indicated in the accompanying table. Commons are internally connected together.
For 1794-OB8EPXT, connect associated output common to odd-numbered terminals on row A or associated terminals on row B.
3. For 1794-IB10XOB6XT, connect the associated +V DC power lead of the input device to the corresponding terminal on the 34...51 row (C) for each input as indicated in the table. The +V power terminals of row (C) are internally connected together.
4. For 1794-IB10XOB6XT, connect the associated input device common (3-wire devices only) and output device common to the corresponding terminals on the 16-33 row. (B) for each input and output as indicated in the table below. Commons are internally connected together.
5. Connect +V DC power to terminal 34 on the 34...51 row (C).
6. Connect -V DC common to terminal 16 on the 16...33 row (B).
7. If daisy chaining power to the next terminal base, connect a jumper from terminal 51 (+V DC) on this base unit to terminal 34 on the next base unit.
8. If continuing -V DC common to the next base unit, connect a jumper from terminal 33 (common) on this base unit to terminal 16 on the next base unit.

Connect Wiring for the 1794-IB16XT

1. Connect individual input wiring to numbered terminals on the 0...15 row (A) as indicated in [Table 3 on page 6](#).
2. Connect the associated +V DC power lead of the input device to the corresponding terminal on the 34...51 row (C) for each input as indicated in the accompanying table. The +V power terminals of row (C) are internally connected together.
3. Connect the associated input common (3-wire devices only) to the corresponding terminal on the 16...33 row. (B) for each input as indicated in the accompanying table. Commons are internally connected together.
4. Connect +V DC power to terminal 34 on the 34...51 row (C).
5. Connect DC common to terminal 16 on the 16...33 row (B).
6. If daisy chaining power to the next terminal base, connect a jumper from terminal 51 (+V DC) on this base unit to terminal 34 on the next base unit.
7. If continuing DC common to the next base unit, connect a jumper from terminal 33 (common) on this base unit to terminal 16 on the next base unit.

Table 1 - Wiring Connections for the 1794-0B16PXT (with 1794-TB2, 1794-TB3, or 1794-TB3S)

Output	Output Terminal	Common Terminal
Output 0	A-0	B-17
Output 1	A-1	B-18
Output 2	A-2	B-19
Output 3	A-3	B-20
Output 4	A-4	B-21
Output 5	A-5	B-22
Output 6	A-6	B-23
Output 7	A-7	B-24
Output 8	A-8	B-25
Output 9	A-9	B-26
Output 10	A-10	B-27
Output 11	A-11	B-28
Output 12	A-12	B-29
Output 13	A-13	B-30
Output 14	A-14	B-31
Output 15	A-15	B-32
+V DC	C-34...C-51 (C-34 and C-51 for 1794-TB2)	
Common	B-16...B-33	

Table 2 - Wiring Connections for the 1794-0B8EPXT

Output	1794-TB2, 1794-TB3, 1794-TB3S		1794-TBN	
	Output Terminal	Common Terminal ⁽¹⁾	Output Terminal	Common Terminal ⁽²⁾
Output 0	A-0	A-1/B-17	B-0	C-1
Output 1	A-2	A-3/B-18	B-2	C-3
Output 2	A-4	A-5/B-19	B-4	C-5
Output 3	A-6	A-7/B-20	B-6	C-7
Output 4	A-8	A-9/B-21	B-8	C-9
Output 5	A-10	A-11/B-22	B-10	C-11
Output 6	A-12	A-13/B-23	B-12	C-13
Output 7	A-14	A-15/B-24	B-14	C-15
+V DC	C-34...C-51 (C-34 and C-51 for 1794-TB2, 1794-TBN)			
Common	B-16...B-33 (B-16 and B-33 for 1794-TBN)			

(1) 1794-TB2, 1794-TB3, 1794-TB3S - A-1, A-3, A-5, A-7, A-9, A-11, A-13, and A-15 are connected together inside the module to 24V DC common.

(2) 1794-TBN - C-1, C-3, C-5, C-7, C-9, C-11, C-13, and C-15 are connected together inside the module to 24V DC common.

Table 3 - Wiring Connections for the 1794-1B16XT (with 1794-TB3 or 1794-TB3S)

Input	Input Terminal	Voltage Terminal	Common Terminal ⁽¹⁾
Input 0	A-0	C-35	B-17
Input 1	A-1	C-36	B-18
Input 2	A-2	C-37	B-19
Input 3	A-3	C-38	B-20
Input 4	A-4	C-39	B-21
Input 5	A-5	C-40	B-22
Input 6	A-6	C-41	B-23
Input 7	A-7	C-42	B-24
Input 8	A-8	C-43	B-25
Input 9	A-9	C-44	B-26
Input 10	A-10	C-45	B-27
Input 11	A-11	C-46	B-28
Input 12	A-12	C-47	B-29
Input 13	A-13	C-48	B-30
Input 14	A-14	C-49	B-31
Input 15	A-15	C-50	B-32
+V DC	C-34...C-51		
Common	B-16...B-33		

(1) 3-wire devices use input, supply and common; 2-wire devices use input and supply.

Table 4 - Wiring Connections for 1794-IB10X0B6XT

Input ⁽¹⁾	Signal	Return	Supply
Sink Input			
Input 0	A-0	B-17	C-35
Input 1	A-1	B-18	C-36
Input 2	A-2	B-19	C-37
Input 3	A-3	B-20	C-38
Input 4	A-4	B-21	C-39
Input 5	A-5	B-22	C-40
Input 6	A-6	B-23	C-41
Input 7	A-7	B-24	C-42
Input 8	A-8	B-25	C-43
Input 9	A-9	B-26	C-44
Source Output			
Output 0	A-10	B-27	
Output 1	A-11	B-28	
Output 2	A-12	B-29	
Output 3	A-13	B-30	
Output 4	A-14	B-31	
Output 5	A-15	B-32	
+V DC	C-34...C-51 (internally connected together)		
Common	B-16...B-33 (internally connected together)		

(1) 2-wire input devices use signal and supply terminals. 3-wire devices use signal, return and supply terminals.

1794-TB2, 1794-TB3, and 1794-TB3S Terminal Base Wiring for the 1794-0B8EPXT and the 1794-0B16PXT

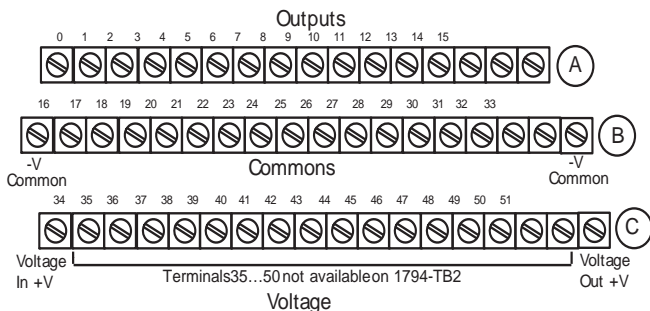

(1794-TB3 shown)

Connect -V (Supply Common) to terminal B-16
 Connect +V (Supply +Voltage) to terminal C-34
 Use B-33 and C-51 for daisy-chaining to next terminal base unit.

Total current draw through the terminal base is limited to 10A.
 Separate power connections to each terminal base may be necessary.

1794-TBN Terminal Base Wiring for the 1794-0B8EPXT

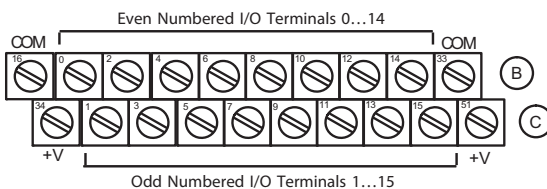

Connect -V (Supply Common) to terminal B-16
 Connect +V (Supply +Voltage) to terminal C-34
 Use B-33 and C-51 for daisy-chaining to next terminal base unit.

Total current draw through the terminal base is limited to 10A.
 Separate power connections to each terminal base may be necessary.

1794-TB3 and 1794-TB3S Terminal Base Wiring for the 1794-IB16XT

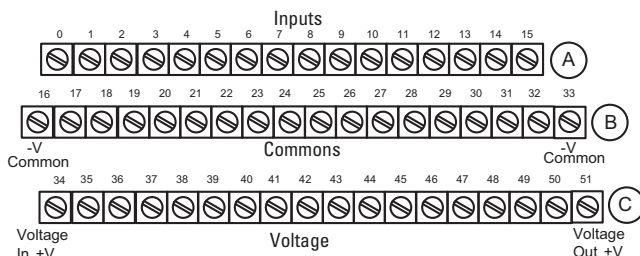

(1794-TB3 shown)

Connect -V (Supply Common) to terminal B-16
 Connect +V (Supply +Voltage) to terminal C-34
 Use B-33 and C-51 for daisy-chaining to next terminal base unit.

1794-TB3 and 1794-TB3S Terminal Base Wiring for the 1794-IB10X0B6XT

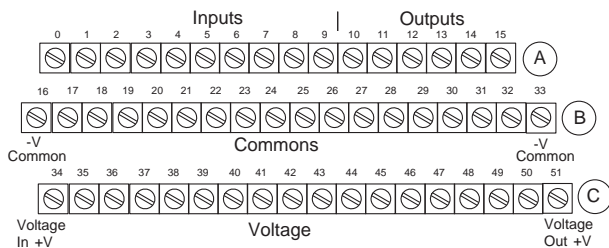

-V (Supply Common) = Terminals B-16 and B-33
 +V (Supply +Voltage) = Terminals C-34 and C-51
 Use B-33 and C-51 for daisy-chaining to next terminal base unit.

(1794-TB3 shown)

2 and 3-Wire Input Wiring for the 1794-IB16XT and 1794-IB10X0B6XT

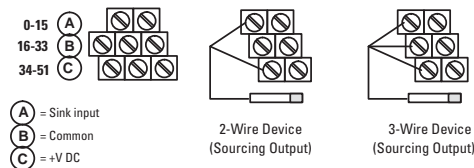

Configure Your Module

Configure your output/input module by setting bits in the configuration word.

Configuration

Dec.	15	14	13	12	11	10	9	8	7	6	5	4	3	2	1	0	
Oct.	17	16	15	14	13	12	11	10	7	6	5	4	3	2	1	0	
1794-0B8EPXT																	
Read	F7	F6	F5	F4	F3	F2	F1	F0	Reserved ⁽¹⁾ (see note)								
Write	Not used							FR	07	06	05	04	03	02	01	00	
Write																	
1794-0B16PXT																	
Read	Not used																
Write	015	014	013	012	011	010	09	08	07	06	05	04	03	02	01	00	
Write 1794-0B32P only	031	030	029	028	027	026	025	024	023	022	021	020	019	018	017	016	
1794-IB16XT																	
Read 1	I15	I14	I13	I12	I11	I10	I9	I8	I7	I6	I5	I4	I3	I2	I1	I0	
Read 2	C = Counter Input value of input 15 ⁽²⁾																
Write 1	Not used		CF ⁽²⁾	CR ⁽²⁾	Not used						Input Filter 12-15			Input Filter 0-11			
1794-IB10X0B6XT																	
Read 1	Not used							I9	I8	I7	I6	I5	I4	I3	I2	I1	I0
Write 2	Not used										05	04	03	02	01	00	
Write 3	Not used							FT			Not used						

Where:
 0 = Output - 00 corresponds to output 0, 01 corresponds to output 1
 F = Overload fault bits - 1 = fault present; 0 = no fault
 FR = Fault reset bit - 1 = reset output; 0 = no change
 I = Input
 C = Counter value for input 15
 CR = Counter reset
 CF = Counter fast - where 1 = fast input (raw data), 0 = standard input filtered data
 FT = Input Filter Time for input channels
 1794-0B16PXT uses outputs 0...3

(1) The unused lower byte in read word 1 floats during operation. Do not use this byte for fault status. See [Program the 1794-0B8EPXT on page 10](#).
 (2) C, CR, and CF not available when used with any series 1794-ASB or 1794-ASB2 remote I/O adapter modules.

Set the Input Filter Time (1794-IB16XT and 1794-IB10X0B6XT)

To set the input filter time, set the associated bits in the output image table (complementary word) for the module.

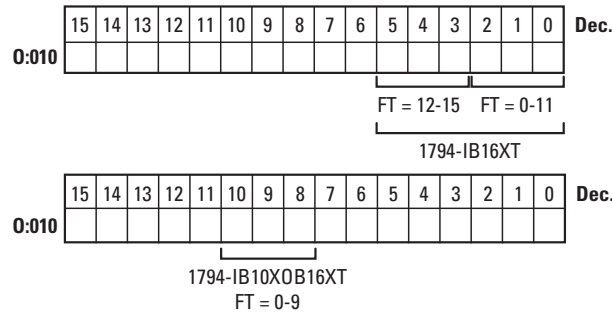

As an example for 1794-IB16XT, to increase the Off-to-On filter time to 4 ms for all inputs at address rack 1, module group 0, set bits and program as shown in Figure 1. For 1794-IB10X0B6XT, increase the Off-to-On filter time to 8 ms for all inputs at address rack 1, module group 0, in configuration word 3, by setting bits as shown.

Figure 1 - Write Filter Time on System Startup

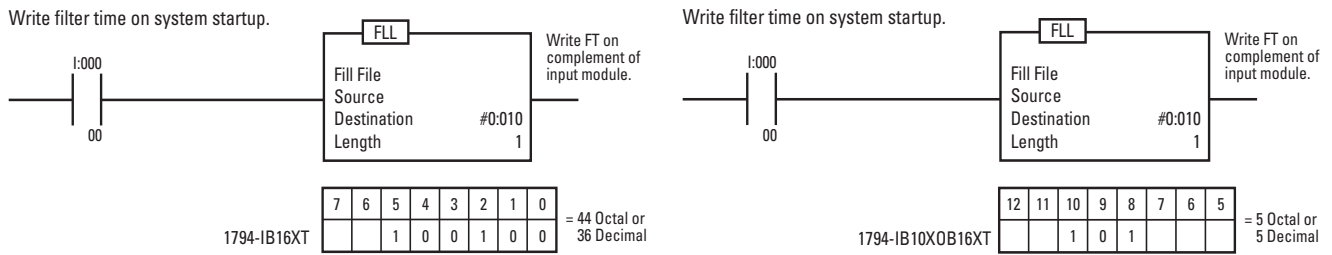

See Table 5 and Table 6 for other bit settings.

Table 5 - Input Filter Time (1794-IB16XT)

Bits			Description - Filter Time	Filter Time
02	01	00	Inputs 0...11	1794-IB16XT
05	04	03	Inputs 12...15	
0	0	0	Filter time 0 (default)	0.25 ms
0	0	1	Filter time 1	0.5 ms
0	1	0	Filter time 2	1 ms
0	1	1	Filter time 3	2 ms
1	0	0	Filter time 4	4 ms
1	0	1	Filter time 5	8 ms
1	1	0	Filter time 6	16 ms
1	1	1	Filter time 7	32 ms

Table 6 - Input Filter Time (1794-IB10X0B6XT)

Bits			Description	
10	09	08	Filter Time for Inputs	Off to On/On to Off
0	0	0	Filter Time 0	0.25 ms
0	0	1	Filter Time 1	0.5 ms
0	1	0	Filter Time 2	1.0 ms
0	1	1	Filter Time 3	2.0 ms
1	0	0	Filter Time 4	4.0 ms
1	0	1	Filter Time 5	8.0 ms
1	1	0	Filter Time 6	16.0 ms
1	1	1	Filter Time 7	32.0 ms

Program the 1794-OB8EPXT

If your program automatically checks for fault bits, bits 8...15 of read word 1 must be masked. This is a sample program for a module at rack address 1, group 0. Add similar rungs to your program.

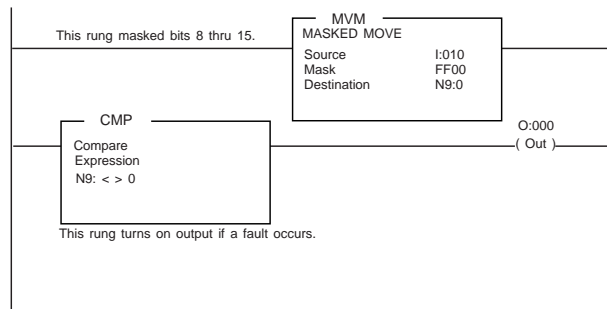

Reset a Fault on the 1794-OB8EPXT

Faults can be reset in three ways:

- Press the fault reset button on the front of the module.
- Toggle the output reset bit (write word 1, bit 08).
- Cycle backplane power.

Use the Reset Button on the 1794-OB8EPXT

When you press the reset button, the fault indicator for the faulted output turns off for about 1.2 s. After the delay, the faulted output attempts to turn on. If the external condition causing the fault is corrected, the output will remain on, the fault indicator is off, and the status indicator is on.