



Price index



IPA Qualification Certificate Air Cleanless Class ISO Class 3 (at v = 2 m/s) upon request



ESD classification: Electrically conductive ESD/ATEX version upon request



UL94 V2 classifications upon request



Snap-open mechanism, choice of snap-open on left or right. Hinged crossbar can be swiveled by more than 180° on both sides. Lightning-fast closing by hand. Secure fit without additional locking devices.



When to use the Series 1400/1450/1480/1500:

- If snap-open accessibility along inner or outer radius is required
- If integrated strain relief is required at the connection point
- If half E-Tube is required (Series 1450)
- If fully enclosed E-Tube is required (Series 1480)
- If long service life is required
- If easy installation is required
- Standard product with many accessories



When not to use it:

- If the application is very simple
  - ▶ Easy Chain®, Series E14, page 3.32

- ① Opening system for rapid opening, either from the right or the left
- ② Double stop dog for long unsupported length
- ③ Cross bars with high locking range
- ④ Series 1400 snap-open on both sides along inner radius
- ⑤ Series 1500 snap-open on both sides along outer radius
- ⑥ Series 1450 half E-Tube snap-open on both sides along inner radius
- ⑦ Series 1480 fully enclosed E-Tube snap-open on both sides along inner radius
- ⑧ Tried-and-tested mounting bracket
- ⑨ Modular interior separation
- ⑩ Easy assembly by optimized pin
- ⑪ Integrated strain relief possible
- ⑫ Also available as ESD version

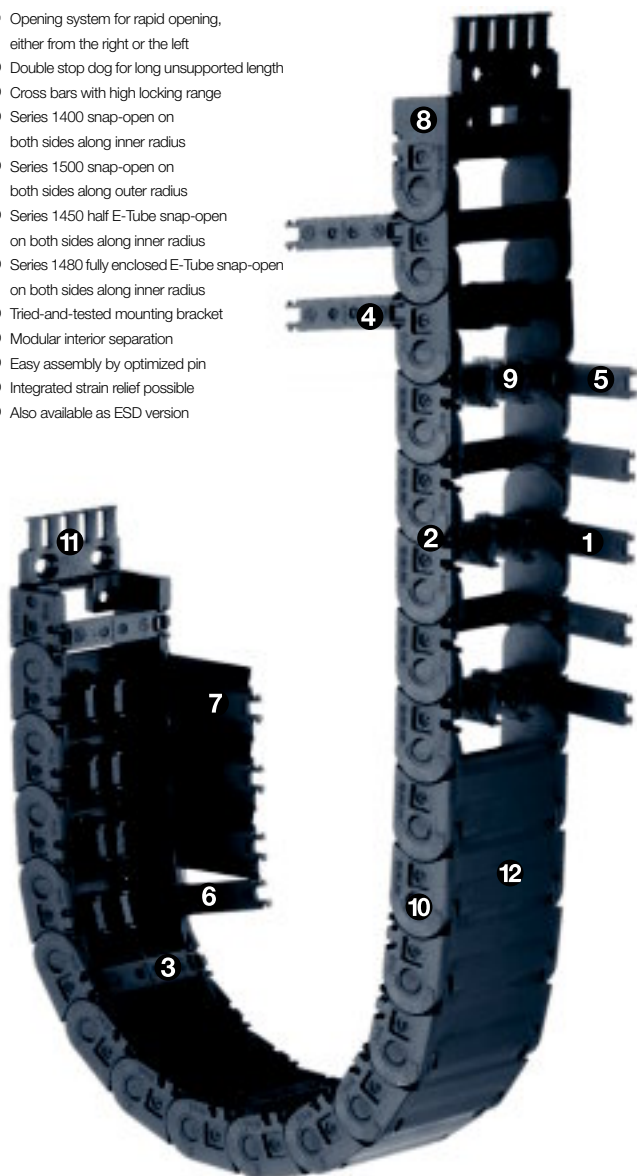

Order example complete E-Chain®

Please indicate chain-lengths or number of links Example: 3 m or 90 links

3 m 1400.038.100.0

E-Chain®

with 2 separators 14011 assembled every 2<sup>nd</sup> link

Interior separation

1 set 15000.038.34PZB

Mounting bracket



### Unsupported length

$FL_G$  = with straight upper run

$FL_B$  = with permitted sag

Further information ► **Design, page 1.12**

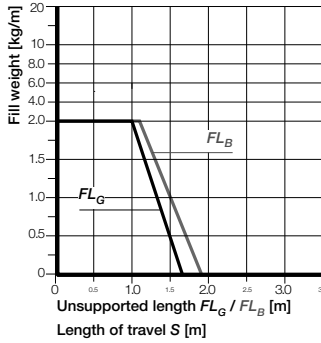
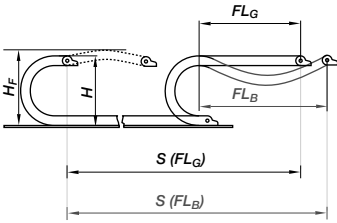

- $S$  = Length of travel
  - $R$  = Bending radius
  - $H$  = Nominal clearance height
  - $H_f$  = Required clearance height
  - $H_{RI}$  = Trough inner height
  - $D$  = Overlength E-Chain® radius in final position
  - $K = \pi \cdot R + \text{"safety"}$
  - $D_2$  = Over length - long travels, gliding
  - $K_2$  = "Further add-on"
  - $H_2$  = "Mounting height"
- \*if the mounting bracket location is set lower

#### Other installation methods

- Vertical, hanging  $\leq 20$  m
- Vertical, standing  $\leq 2$  m
- Side mounted, un supp.  $\leq 0,7$  m
- Rotary requires further calculation
- Unsupported length of upper run = upon request

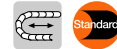

### Short travels - unsupported

Unsupported E-Chains® feature positive camber over short travels. This must be accounted for when specifying the clearance height  $H_f$ . Please consult igus® if space is particularly restricted.

The required clearance height:  
 $H_f = H + 25$  mm  
(with 0,5 kg/m fill weight)

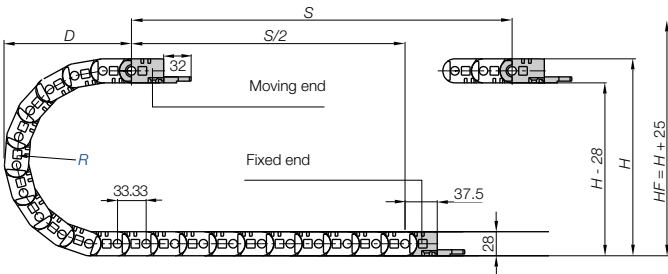

Pitch = 33,3 mm/link    Links/m = 30 (1000 mm)    Chain length =  $S_2 + K$

R	035*	038*	048*	075	100	125	145	180
H	98	104	124	178	228	278	318	388
D	85	90	100	125	150	175	195	230
K	180	190	220	305	385	460	525	635
$H_2$	98	104	124	178	100	100	100	100
$D_2^{*25}$	85	90	100	125	340	495	540	690
$K_2$	180	190	220	305	600	800	940	1170

\*for Series 1450/1480 upon request

### Long travel lengths from 10 m to max. 75 m    Chain length = $S_2 + K_2$

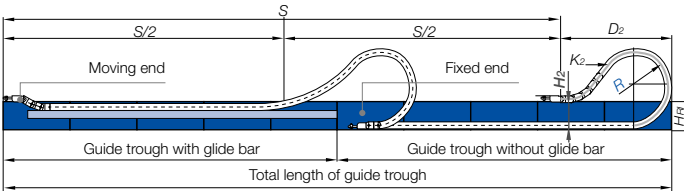

In case of travels between 4 and 10 m we recommend a longer unsupported length.



### Gliding, long travel applications (max. 75 m)

In this case the E-Chain® upper run will be introduced in a guide trough on the lower run. We recommend to realize the engineering of such a plant by our technicians.

### Technical Data

Speed / acceleration $FL_G$	max. 20 [m/s] / max. 200 [m/s <sup>2</sup> ]
Speed / acceleration $FL_B$	max. 3 [m/s] / max. 6 [m/s <sup>2</sup> ]
Gliding speed / acceleration (maximum)	max. 10 [m/s] / max. 50 [m/s <sup>2</sup> ]
Material - permitted temperature °C	igumid G / -40° up to +120° C
Flammability class, igumid G	VDE 0304 IIC UL94 HB



Details of material properties  
► page 1.38



E2/000 medium  
Inner height: 21 mm

Phone +49- (0) 22 03-96 49-800  
Fax +49- (0) 22 03-96 49-222



► page 5.91

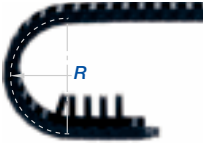
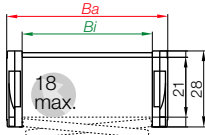

Part No. structure

1400.015.035.0



**Series 1400 - E-Chain® - snap-open along inner radius**

Part No.	Bi [mm]	Ba [mm]	R [mm]	Bending radii								Weight [kg/m]
1400.015.	15	28,5	035	038	048	075	100	125	145	180	~ 0,46	
1400.020.	20	33,5	035	038	048	075	100	125	145	180	~ 0,47	
1400.025.	25	38,5	035	038	048	075	100	125	145	180	~ 0,49	
1400.038.	38	51,5	035	038	048	075	100	125	145	180	~ 0,53	
1400.050.	50	63,5	035	038	048	075	100	125	145	180	~ 0,56	
1400.068.	68	81,5	035	038	048	075	100	125	145	180	~ 0,63	
1400.080.	80	93,5	035	038	048	075	100	125	145	180	~ 0,67	
1400.100.	100	113,5	035	038	048	075	100	125	145	180	~ 0,74	
1400.125.	125	138,5	035	038	048	075	100	125	145	180	~ 0,83	

Supplement Part No. with required radius. Example: 1400.015.035.0

0 = standard color, other colors ▶ page 1.39 · Pitch = 33,3 mm/link - Links/m = 30

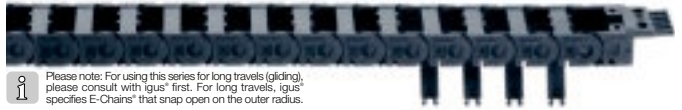

Please note: For using this series for long travels (gliding), please consult with igus® first. For long travels, igus® specifies E-Chains® that snap open on the outer radius.

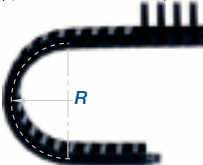
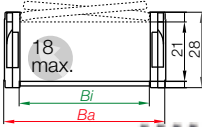

Part No. structure

1500.015.075.0



**Series 1500 - E-Chain® - snap-open along outer radius - Standard!**

Part No.	Bi [mm]	Ba [mm]	R [mm]	Bending radii								Weight [kg/m]
1500.015.	15	28,5	035	038	048	075	100	125	145	180	~ 0,46	
1500.020.	20	33,5	035	038	048	075	100	125	145	180	~ 0,47	
1500.025.	25	38,5	035	038	048	075	100	125	145	180	~ 0,49	
1500.038.	38	51,5	035	038	048	075	100	125	145	180	~ 0,53	
1500.050.	50	63,5	035	038	048	075	100	125	145	180	~ 0,56	
1500.068.	68	81,5	035	038	048	075	100	125	145	180	~ 0,63	
1500.080.	80	93,5	035	038	048	075	100	125	145	180	~ 0,67	
1500.100.	100	113,5	035	038	048	075	100	125	145	180	~ 0,74	
1500.125.	125	138,5	035	038	048	075	100	125	145	180	~ 0,83	

Supplement Part No. with required radius. Example: 1500.015.075.0

0 = standard color, other colors ▶ page 1.39 · Pitch = 33,3 mm/link - Links/m = 30



**Series 1450 - half E-Tube - snap-open along inner radius**

Part No.	<i>B<sub>i</sub></i> [mm]	<i>B<sub>a</sub></i> [mm]	<i>R</i> [mm]	Bending radii	Weight [kg/m]
1450.015.□.0	15	28,5	075	100 125 145 180	≈ 0,48
1450.025.□.0	25	38,5	075	100 125 145 180	≈ 0,57
1450.038.□.0	38	51,5	075	100 125 145 180	≈ 0,59
1450.050.□.0	50	63,5	075	100 125 145 180	≈ 0,65
1450.068.□.0	68	81,5	075	100 125 145 180	≈ 0,74
1450.080.□.0	80	93,5	075	100 125 145 180	≈ 0,80
1450.100.□.0	100	113,5	075	100 125 145 180	≈ 0,90
1450.125.□.0	125	138,5	075	100 125 145 180	≈ 1,03

The bending radii **035** **038** **048** are available upon request.

Supplement Part No. with required radius. Example: 1450.015.075.0

0 = standard color, other colors ▶ page 1.39 · Pitch = 33,3 mm/link - Links/m = 30

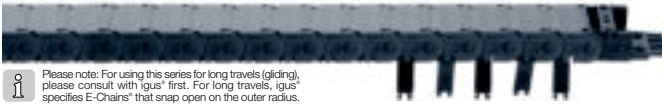

Please note: For using this series for long travels (gliding), please consult with igus® first. For long travels, igus® specifies E-Chains® that snap open on the outer radius.

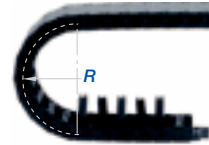
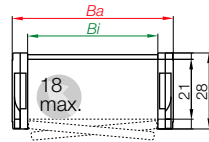

Part No. structure

1450.015.075.0



E2/000 medium  
Inner height: 21 mm

**Series 1480 - E-Tube - snap-open along inner radius**

Part No.	<i>B<sub>i</sub></i> [mm]	<i>B<sub>a</sub></i> [mm]	<i>R</i> [mm]	Bending radii	Weight [kg/m]
1480.015.□.0	15	28,5	075	100 125 145 180	≈ 0,48
1480.025.□.0	25	38,5	075	100 125 145 180	≈ 0,54
1480.038.□.0	38	51,5	075	100 125 145 180	≈ 0,61
1480.050.□.0	50	63,5	075	100 125 145 180	≈ 0,67
1480.068.□.0	68	81,5	075	100 125 145 180	≈ 0,77
1480.080.□.0	80	93,5	075	100 125 145 180	≈ 0,84
1480.100.□.0	100	113,5	075	100 125 145 180	≈ 0,95
1480.125.□.0	125	138,5	075	100 125 145 180	≈ 1,08

The bending radii **035** **038** **048** are available upon request.

Supplement Part No. with required radius. Example: 1480.038.075.0

0 = standard color, other colors ▶ page 1.39 · Pitch = 33,3 mm/link - Links/m = 30



Please note: For using this series for long travels (gliding), please consult with igus® first. For long travels, igus® specifies E-Chains® that snap open on the outer radius.

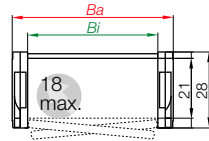

Part No. structure

1480.038.075.0



Phone +49- (0) 22 03-96 49-800  
Fax +49- (0) 22 03-96 49-222



▶ page 5.91

Vert. Separator, slotted		
unassembled	14001	
assembled	14011	

### Option 1: Vertical Separators for E-Chains® Series 1400 · 1500

Vertical Separators are used if a vertical subdivision of the E-Chain® interior is required -

By standard Vertical Separators are assembled every other E-Chain® link

- Standard subdivision with Vertical Separator, slotted 14011, for combinations with Full-Width Shelf 111.X

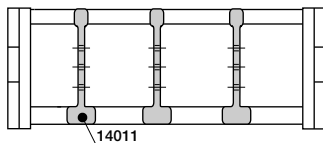

Vert. Separator, slotted		
unassembled	14501	
assembled	14511	

### Option 2: Vertical Separators for E-Tubes Series 1450 · 1480

Vertical Separators are used if a vertical subdivision of the half E-Tube (Series 1450) and the fully enclosed E-Tube (Series 1480) interior is required -

By standard Vertical Separators are assembled every other E-Chain® link

- Standard subdivision with Vertical Separator, slotted 14511, for combinations with Full-Width Shelf 111.X

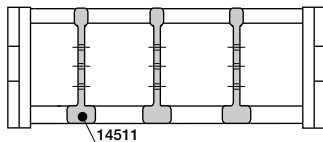

### Option 3: Full-Width Shelves for E-Chains® Series 1400 · 1500 and E-Tubes Series 1450 · 1480

For applications involving many cables with similar or identical diameters

- Full-Width Shelf 111.X can be combined with Vertical Separator, slotted 14011 (E-Chain®) and Vertical Separator, slotted 14511 (E-Tube/half E-Tube)

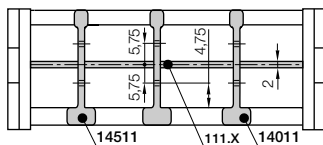

Full-Width Shelf
X
t = 2

Width X [mm]	Part No. unassembled	Part No. assembled
015	110.15	111.15
020	110.20	111.20
025	110.25	111.25
038	110.38	111.38
050	110.50	111.50

Width X [mm]	Part No. unassembled	Part No. assembled
068	110.68	111.68
080	110.80	111.80
100	110.100	111.100
125	110.125	111.125

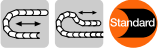

### The Standard - one-piece mounting brackets - pivoting

- Recommended for unsupported and gliding applications
- Well suited for tight installation conditions
- Integrated multistage strain relief
- Easy to assemble
- Various mounting positions

Moving end with bore (outer link) 14...3PZ

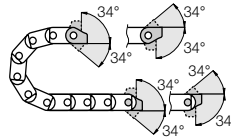

14...4PZ Fixed end with pin (inner link)

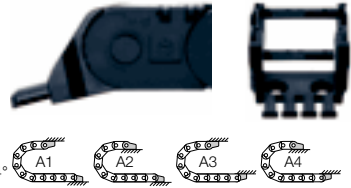

Possible installation conditions for assembled mounting brackets ▶ Order example "preassembled" below

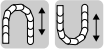

### One-piece mounting brackets - locking

- Recommended for unsupported and gliding applications
- Furthermore:
- At very high speed and/or acceleration
  - If space is limited for height (the  $H_F$  measurement)
  - Various mounting positions

Moving end with bore (outer link) 14...1PZ

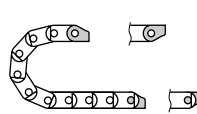

14...2PZ Fixed end with pin (inner link)



Possible installation conditions for assembled mounting brackets ▶ Order example "preassembled" below

14...3PZ Standard! (pivoting)  
14...1PZ (locking)

Moving end

Standard! (pivoting) 14...4PZ (locking) 14...2PZ

Fixed end

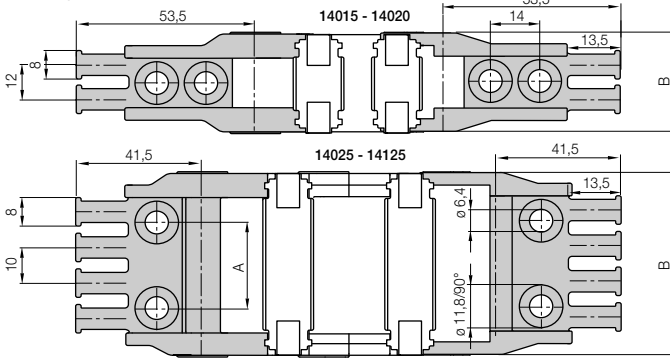

For E-Chain:	Part No. full set with tiewrap plate	Dim.A [mm]	Dim.B [mm]	Number of teeth
1400 - 1500.015 ▶	14015. [ ] PZ	-	28,5	2
1400 - 1500.020 ▶	14020. [ ] PZ	-	33,5	2
1400 - 1500.025 ▶	14025. [ ] PZ	13	38,5	2
1400 - 1500.038 ▶	14038. [ ] PZ	24	51,5	4
1400 - 1500.050 ▶	14050. [ ] PZ	36	63,5	6
1400 - 1500.068 ▶	14068. [ ] PZ	54	81,5	7
1400 - 1500.080 ▶	14080. [ ] PZ	66	93,5	8
1400 - 1500.100 ▶	14100. [ ] PZ	86	113,5	10
1400 - 1500.125 ▶	14125. [ ] PZ	111	138,5	13

Please add the Part No. with the requested index - 34 for the pivoting configuration

e.g. 14015. [34] PZ or 12 for the locking configuration e.g. 14015. [12] PZ

For the preassembled mode please add the index [A1] ... [A4] e.g. 14015. [34] PZ [A1]

### Dimensions and order configurations

Strain relief is possible on the moving end and/or the fixed end.

Part No. structure (pivoting)

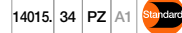

A... must be indicated on preassembled configurations  
With assembled strain relief tiewrap plates  
Full set pivoting = 34  
Mounting brackets for selected chain type

Full set, for both ends:

[14015. [34] PZ] +tiewrap plate

Single-part order:

[14015. [3] PZ] +tiewrap plate

Mounting bracket with bore

[14015. [4] PZ] +tiewrap plate

Mounting bracket with pin

Part No. structure (locking)

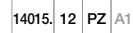

A... must be indicated on preassembled configurations  
With assembled strain relief tiewrap plates  
Full set pivoting = 12  
Mounting brackets for selected chain type

Full set, for both ends:

[14015. [12] PZ] +tiewrap plate

Single-part order:

[14015. [1] PZ] +tiewrap plate

Mounting bracket with bore

[14015. [2] PZ] +tiewrap plate

Mounting bracket with pin



▶ page 5.91

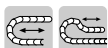

### Mounting bracket - polymer

- Recommended for unsupported and gliding applications
- Well suited for tight installation conditions
- Strain relief with detachable tiwrap plates
- Variable traverse angle for flexible assembly
- The twistability of the E-Chain® and the option to assemble the mounting brackets on the fixed end and/or the moving end, enable various installation options

Moving end with bore  
(outer link) 15000...3PZ(B)

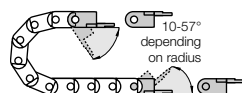

Possible installation conditions for assembled mounting brackets ▶ Order example "preassembled" below

15000...4PZ(B) Fixed end with pin (inner link)

### Dimensions and order configurations

Strain relief is possible on the moving end and/or the fixed end.

15000...3PZ(B)  
Moving end

15000...4PZ(B)  
Fixed end

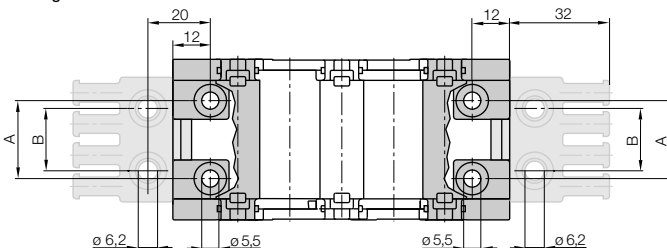

#### Part No. structure

15000.038.34.PZB.A1

- A...must be indicated on preassembled configurations
- With assembled strain relief tiwrap plates
- Full set pivoting = 34
- Width
- Mounting brackets for selected chain type

#### Full set, for both ends:

15000.038.34.PZB +tiwrap plate

#### Single-part order:

15000.038.3.PZB +tiwrap plate

Mounting bracket with bore

15000.038.4.PZB +tiwrap plate

Mounting bracket with pin

For E-Chain®	Part No. full set with tiwrap plate	Part No. full set without tiwrap plate	Dim. A [mm]	Dim. B [mm]
1400 - 1500.015 ▶	-	-	-	-
1400 - 1500.020 ▶	-	-	-	-
1400 - 1500.025 ▶	15000.025.34.PZB	15000.025.34.PZ	12	15
1400 - 1500.038 ▶	15000.038.34.PZB	15000.038.34.PZ	25	20
1400 - 1500.050 ▶	15000.050.34.PZB	15000.050.34.PZ	37	30
1400 - 1500.068 ▶	15000.068.34.PZB	15000.068.34.PZ	55	40
1400 - 1500.080 ▶	15000.080.34.PZB	15000.080.34.PZ	67	60
1400 - 1500.100 ▶	15000.100.34.PZB	15000.100.34.PZ	87	80
1400 - 1500.125 ▶	15000.125.34.PZB*	15000.125.34.PZ	112	105

For the preassembled mode please add the index [A1] ... [A4] e.g. 15000.038.34.PZB[A1]

\*Tie wrap plate (consists of 2 x 2050.ZB) does not snap on but needs to be bolted down separately

Phone +49- (0) 22 03-96 49-800  
Fax +49- (0) 22 03-96 49-222

igus® GmbH  
51147 Cologne

Internet: www.igus.eu  
E-mail: info@igus.de



**Steel mounting bracket - locking**

- Locked connections
- One part for all chain widths
- Electrically conductive
- Bolted connection outside of chain cross-section possible

Moving end with bore  
(outer link) 14000....1

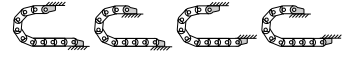
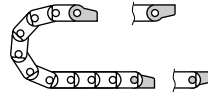

14000...2 Fixed end  
with pin (inner link)

Possible installation conditions -  
Further installation angles ► installation sketch

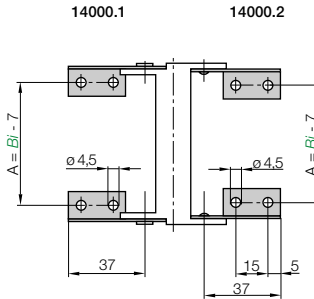
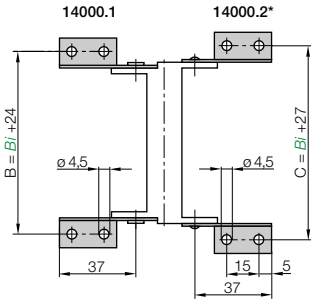

**Dimensions and order configurations**

\*pivoting with no stop, (360°).  
Screw-on area of the mounting brackets can be on the interior or exterior.

For E-Chain*	Part No. full set	Dim. A [mm]	Dim. B [mm]	Dim. C [mm]
1400 - 1500.015 ►	14000. 12	8	39	42
1400 - 1500.020 ►	14000. 12	13	44	47
1400 - 1500.025 ►	14000. 12	18	49	52
1400 - 1500.038 ►	14000. 12	31	62	65
1400 - 1500.050 ►	14000. 12	43	74	77
1400 - 1500.068 ►	14000. 12	61	92	95
1400 - 1500.080 ►	14000. 12	73	104	107
1400 - 1500.100 ►	14000. 12	93	124	127
1400 - 1500.125 ►	14000. 12	118	149	152

14000. 12 Full set, 4 parts  
2 with pin / 2 with bore

Single-part order:

14000. 1 Mounting bracket with bore, 1 part left / right

14000. 2 Mounting bracket with pin, 1 part left / right

Phone +49- (0) 22 03-96 49-800  
Fax +49- (0) 22 03-96 49-222

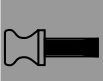
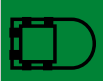



igus® E-ChainSystems®

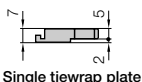

Single tie-wrap plate



Shown assembled

### Tie-wrap plate as individual part

As individual component screwed on KMA. Can be plugged in the mounting brackets. **Details ► chapter 10**

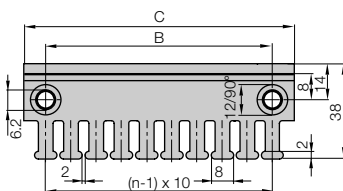

Tie-wrap plate	No. of teeth <i>n</i>	Dim. C [mm]	Dim. B [mm]
2020.ZB	3	30	15
2030.ZB	4	40	20
2040.ZB	5	50	30
2050.ZB	6	60	40
2070.ZB	8	80	60
2090.ZB =			
(2030.ZB + 2040.ZB)	9	90	–
2100.ZB	10	100	80
2125.ZB =			
(2050.ZB + 2050.ZB)	12	120	–

Phone +49- (0) 22 03-96 49-800  
Fax +49- (0) 22 03-96 49-222



### Cable tiewraps as individual part

Cable tiewraps (100-piece bag)	Width x length	max. Ø	Tensile strength
CFB.001	4,8 x 150 mm	36 mm	222 N



### Strain relief for steel mounting brackets

Clip-on connection is not possible with steel mounting brackets. In this case, the tie-wrap plates must be bolted directly into separate bore holes in front of the mounting bracket. Alternatively the tie-wrap plates 20XX.ZB can be also used here. **Details ► chapter 10**

igus® GmbH  
51147 Cologne



Other strain relief elements - optional ► chapter 10

Internet: [www.igus.eu](http://www.igus.eu)  
E-mail: [info@igus.de](mailto:info@igus.de)

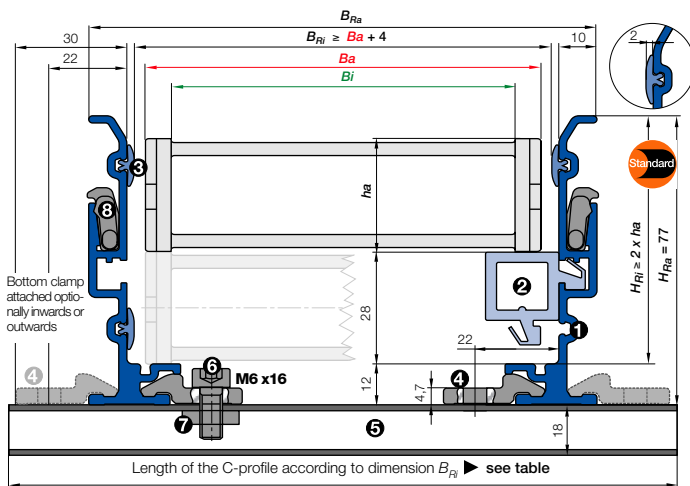

- $B_a$  = Outer width E-Chains® / E-Tube
  - $B_i$  = Inner width E-Chains® / E-Tube
  - $h_a$  = Outer height E-Chains® / E-Tube
  - $H_{Ri}$  = Inner trough height
  - $H_{Ra}$  = Outer trough height
  - $B_{Ri}$  = Inner trough width ▶ depends on dim.  $B_a$
  - $B_{Ra}$  = Outer trough width
  - $n_{Mon}$  = Number of installation sets (left/right)
  - $n_{Ri}$  = Number of trough sets (left/right)
- $H_{Ri} \geq 2 \cdot h_a$   
 $B_{Ri} \geq B_a + 4$
- = Guide trough set
  - = Installation set "Basic"
  - = C-profile
  - = Glide bar

### Installation set "Basic" with C-profile

Bottom Clamp attached optionally inwards or outwards

1500.050.035.0 ▶ Order example

$B_{Ri}$ [mm]	Part No. attached	
	inwards	outwards
.015	33	960.30.125
.020	38	960.30.125
.025	43	960.30.150
.038	56	960.30.150
.050	68	960.30.125
.068	86	960.30.150
.080	98	960.30.150
.100	118	960.30.175
.125	143	960.30.200



- **Components, trough "Basic":** ① Trough side parts, aluminum, 2 m ② Glide bar, plastic, 2 m ③ Glide strips, plastic, 2 m (without glide strips on request)
- **Components, installation set "Basic":** ④ Bottom clamp, aluminum ⑤ C-profile, steel galvanized ⑥ Screw M6 x16 ⑦ Sliding nut M6 ⑧ Interface connector, plastic

### Order example: Length of travel 30 m - Center mounted for Series 1500.050.035.0 with $B_{Ri} = 68$

- Guide trough set (set of 2 trough side parts, incl. glide strips) **without** glide bar  
**Order text: 16 m guide trough without glide bar (8 x 2 m sections) Part No. 970.30.SL**
- Guide trough set (set of 2 trough side parts, incl. glide strips) **with** glide bar  
**Order text: 16 m guide trough with glide bar (8 x 2 m sections) Part No. 970.32.SL**
- Installation set "Basic" complete (guide trough-sets + 1)  
**Order text: 17 installation sets "Basic" Part No. 960.30.125**
- Module for the fixed end  
**Order text: 1 set Part No. 970.80**
- Option:** For an additional noise dampening with silencer profile, please add Index A - Example:  
**Part No. 970.30.SLA**

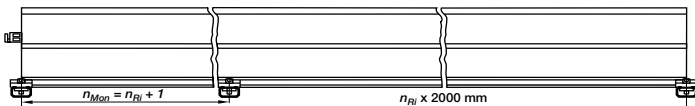

Principle sketch: Number of installation sets to be installed = **Number of trough sections + 1**

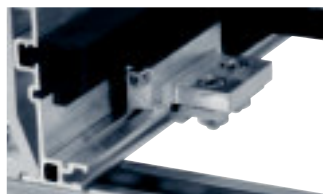

### A quick fix for mounting the stationary end of an E-Chain®

With this module for the fixed end, fast and easy mounting onto the Aluminum "SuperTrough" is now possible without any drilling. Fast mounting of the E-Chain® by clamping onto the aluminum trough

- Quick relocation of the stationary end
- No drilling necessary

Phone +49- (0) 22 03-96 49-800  
 Fax +49- (0) 22 03-96 49-222



▶ page 5.91