



Note on instructions

When working in hazardous areas, the safety of personnel and equipment depends on compliance with the relevant safety regulations. The people in charge of installation and maintenance bear a special responsibility. It is essential that they have an exact knowledge of the applicable rules and regulations.

The instructions provide a summary of the most important safety measures and must be read by everyone working with the product so that they will be familiar with the correct handling of the product.

The instructions have to be kept for future reference and must be available throughout the expected life of the product.

Description

The switch module, type 07-3323-1.00, is used everywhere in almost all hazardous areas where machine functions are to be activated by pressing a button or actuating a switch.

The switch module is equipped with self-cleaning contacts featuring positive break operation.

The connection is established by means of terminals at the back of the switch module.

The switch module is designed for combining with different actuating elements. It is attached without tools to the actuating element.

The actuating element is inserted into a mounting hole in an Ex e enclosure, a control console or control panel. The easy installation of the actuator allows conformance to a high IP degree of protection.

Explosion protection

ATEX

Ex protection type

II 2G Ex d e IIC Gb

I M2 Ex de I Mb

Certification

PTB 99 ATEX 1043 U

IECEX

Ex protection type

Ex d e IIC Gb

Ex d e I Mb

Certification

IECEX PTB 07.0046U

UL

Ex protection type

Class I, Zone 1, AEx de IIC/Ex de IIC, T6

Class I, Div. 2, Groups A, B, C, D

Certification

UL E184198

Ambient temperature ranges

-55 °C to +60 °C

(-67 °F to +140 °F)

Approved for the zone

1

Technical data

Protection class

Determined by actuating element and control unit enclosure.

Terminals: IP 20

Weight

Approx. 87 g (0.19 lb)

Rated insulation voltage

690 V

Rated voltage

AC 230 V and 400 V

DC 24 V and 110 V

Storage / transport temperature

-55 °C to +70 °C

(-67 °F to +158 °F)

Enclosure material / manufacturing process

Thermoplastic / injection moulding

Contact material

AgSnO₂

Contacts

1 N/C contact and 1 N/O contact or 2 N/O contacts or 2 N/C contacts

AC-12: 16 A, 400 V

AC-15: 10 A, 400 V

DC-13: 0.5 A, 110 V

DC-13: 1 A, 24 V

Conventional thermal current

16 A / +40 °C (+104 °F)

11 A / +60 °C (+140 °F)

Connection

Terminal for 2.5 mm², fine-wire

Service life

Mechanical: > 10⁵ switching cycles

Mounting

Locked, by bayonet lock

Dimensions

See page 3

Safety Instructions

The switch module and its actuating element may be used only within the specified ambient and operating temperature range.

Utilization in areas other than those specified or the alteration of the product by anyone other than the manufacturer will exempt BARTEC from liability for defects or any further liability.

Incorrect installation can cause malfunctioning and the loss of explosion protection.

The generally applicable statutory rules and other binding directives relating to workplace safety, accident prevention and environmental protection must be observed.

Before commissioning or restarting operation, check compliance with the applicable laws and directives.

The switch module may be used only if it is clean and not damaged in any way. It is not permissible to modify the module in any way.

Marking

Particularly important points in these instructions are marked with a symbol:

DANGER

DANGER indicates a hazardous situation which, if not avoided, will result in death or serious injury.

WARNING

WARNING indicates a hazardous situation which, if not avoided, could result in death or serious injury.

CAUTION

CAUTION indicates a hazardous situation which, if not avoided, could result in minor or moderate injury.

NOTICE

NOTICE is used to address practices not related to personal injury.

Note

Important instructions and information on effective, economical and environmentally compatible handling.

Standards conformed to

IEC 60079-0:2007

EN 60079-0:2009

IEC/EN 60079-1:2007

IEC 60079-7:2006

EN 60079-7:2007

DIN EN 60068-2-27:2010, 30 g, 18 ms

Transport, Storage

NOTICE

Switch module damage through incorrect transport or incorrect storage.

- Transport and storage is permissible in original packaging only.

Assembly, Installation, and Commissioning

WARNING

Risk of serious injury due to incorrect proceedings.

- Only authorized and qualified personnel may do any of the assembly, disassembly, installation and commissioning work.
- Use suitable tools.

Assembly/disassembly

Mounting the switch module:

- Make sure the switch module to be attached is intact (no cracks).
- Position the switch module's bayonet lock at the mounted actuating element.
- Turn the closing latch to connect the switch module securely to the actuating element.

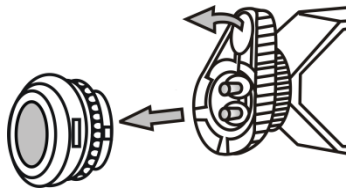

Note

The assembly of the actuating element as well as the assembly of the switch module and the actuating element is described in the operating instructions for actuating elements, type 05-0003-00./....

Installation

In hazardous areas groups I and II, the switch module must be used:

- In appropriate enclosures with "Ex e" increased safety type of protection. The clearance and creepage distances under IEC/EN 60079-7 Section 4.3, Section 4.4 and Table 1 must be observed.
- In an enclosure that corresponds to another approved type of protection specified in IEC/EN 60079-0 Section 1.

Take care when connecting conductors:

- Strip 40 mm (1.6 in) sheath off the conductor.
- Remove approx. 6 mm (0.2 in) conductor insulation from the cores.
- Prepare the ends of fine-stranded and multi-stranded conductors: Crimp wire end sleeves with suitable crimping tools. Connection cross-sections: 0.75-2.5 mm² (14-18 AWG).
- Release terminals.
- Insert conductors.
- Tight the terminals with a maximum torque of 0.4-0.7 Nm.

Contact arrangements:

Type 073323-1100
2 N/C contacts

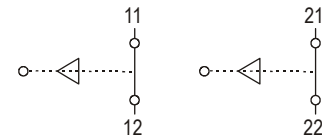

Type 07-3323-1200
2 N/O contacts

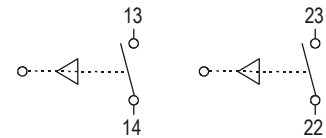

Type 07-3323-1400
1 N/O contact and 1 N/C contact

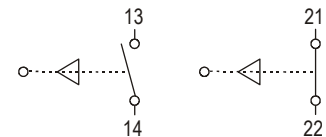

Commissioning

Before commissioning, check that:

- The device has been installed in compliance with regulations.
- The device is not damaged.
- The connection has been established properly (make sure the cores are secure).

Maintenance and Fault Clearance

WARNING

Risk of serious injury due to incorrect proceedings.

- Only authorized qualified personnel may do any of the work relating to maintenance and fault clearance.
- IEC/EN 60079-17 must be observed.

The operator of the switch module must keep it in good condition, operate it properly, monitor it and clean it regularly.

Maintenance

WARNING

Risk of serious accidents due to damaged parts.

- Check switch modules, actuating elements, actuators, sealings, and cables regularly for cracks and damage. Make sure that they are properly established.

NOTICE

Switch module/ actuating element damage due to incorrect cleaning.

- It is not allowed to clean switch modules/ actuating elements with compressed air.

Fault Clearance

WARNING

Risk of serious injury due to use of non-original spare parts.

- Use original parts only as replacements.

The switch module is defective if the switching unit does not perform switching functions any longer.

Defective switch modules cannot be repaired; they must be replaced considering this operational instruction.

Defective actuating elements can be removed from the switch module and replaced by functioning actuating elements of the same type.

Accessories, Spare Parts

See BARTEC catalogue.

Disposal

The components in the switch module and the actuator contain metal and plastic parts.

Therefore the statutory requirements for disposing of electronic scrap must be observed (e.g. disposal by an approved disposal company).

Service Address

BARTEC GmbH
Max-Eyth-Straße 16
97980 Bad Mergentheim
Germany
Tel.: +49 7931 597-0
Fax: +49 7931 597-119

Installation dimensions

NOTICE

Damage to elements due to incorrect installation dimensions.

- The minimum spacing between the mounting holes must be observed.

Dimensions in mm (in)

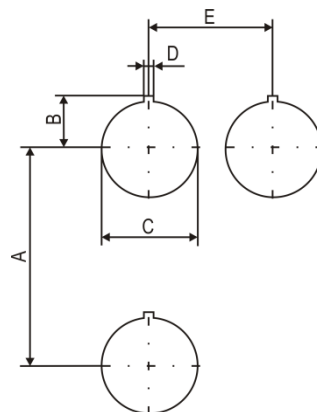
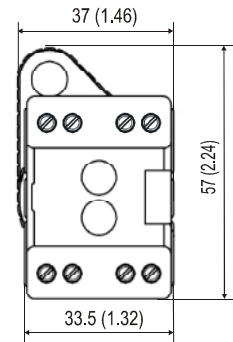
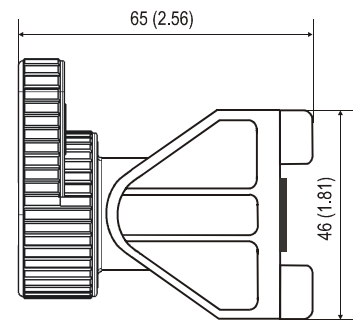

Dimensions:

	mm	in
A*	70	2.8
B	16.5	0.7
C	∅ 30.3 ^{+0.3}	∅ 1.2 ^{+0.01}
D	3	0.1
E*	40	1.6

*Recommended spacing for mushroom push-button, slam button, and: position selector switches with protective shroud: 100 mm (3.9 in).

Erklärung der Konformität
Declaration of Conformity
Attestation de conformité

N° 01-3320-7C0001_B

BARTEC

BARTEC GmbH
Max-Eyth-Straße 16
97980 Bad Mergentheim
Germany

Wir	We	Nous
BARTEC GmbH,		
erklären in alleiniger Verantwortung, dass das Produkt	declare under our sole responsibility that the product	attestons sous notre seule responsabilité que le produit
Schaltmodul mit Klemmen	Switch module with terminals	Élément de contact avec bornes

Typ 07-332*-1*/***

auf das sich diese Erklärung bezieht den Anforderungen der folgenden Richtlinien (RL) entspricht	to which this declaration relates is in accordance with the provision of the following directives (D)	se référant à cette attestation correspond aux dispositions des directives (D) suivantes
---------------------------------------------------------------------------------------------------------	--------------------------------------------------------------------------------------------------------------	-------------------------------------------------------------------------------------------------

ATEX-Richtlinie 94/9/EG	ATEX-Directive 94/9/EC	ATEX-Directive 94/9/CE
und mit folgenden Normen oder normativen Dokumenten übereinstimmt	and is in conformity with the following standards or other normative documents	et est conforme aux normes ou documents normatifs ci-dessous

EN 60079-0 :2009	EN 60079-1 :2007	EN 60079-7 :2007
DIN EN 60068-2-27 :2010, 30 g 18 ms		
Kennzeichnung	Marking	Marquage

II 2 G Ex de IIC Gb I M2 Ex de I Mb		
Verfahren der EG-Baumusterprüfung / Benannte Stelle	Procedure of EC-Type Examination / Notified Body	Procédure d'examen CE de type / Organisme Notifié

PTB 99 ATEX 1043 U
0102 PTB, Bundesallee 100, 38116 Braunschweig, D
0044

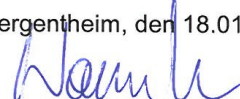
Bad Mergentheim, den 18.01.2012

ppa. Ewald Warmuth
Geschäftsleitung / General Manager

03-0383-0289

01-3323-7D0001/B-02/13-STVT-292807