

2/2-way Solenoid Valve with servo-diaphragm, G 1/2 - G 2 1/2



Type 5281 can be combined with...



Type 2508
Cable plug



Type 1078
Timer unit



Type 2511
ASI cable plug

- Universal version up to 16 bar
- NBR, EPDM or FKM servo-diaphragms
- Anti-waterhammer, low noise
- NC or NO circuit function
- Brass body or grey cast iron
- Threaded port or flange connections

Servo-assisted solenoid valve with servo-diaphragm for the control of liquid or gaseous media. A pressure difference of 0.5 bar is required for a complete switchover.

Power consumption		
Inrush	Hold (hot coil)	
AC [VA]	AC [VA/W]	DC [W]
24	14/8	8

Technical data	
Orifice	DN 13 - 65 mm
Body material	Threaded port Flange
	Brass acc. to DIN EN 50930-6 Grey cast iron
Insulation class	
Seal material version	
NBR	B
EPDM	H
FKM	H
Inner part valve	Stainless steel, brass
Seal material	NBR, EPDM, FKM
Media	
NBR	Neutral media, such as compressed air, water
EPDM	Oil and fat-free media
FKM	Hot air, per-solutions
Media temperature	
NBR	-10 to +80 °C
EPDM	-40 to +90 °C (with epoxy coil to +100°C)
FKM	-10 to +90 °C (with epoxy coil to +120°C)
Ambient temperature	Max. +55 °C
Voltage tolerance	±10 %
Duty cycle	Continuous operation 100% ED
Electrical connection	Tag connector acc. to DIN EN 175301-803 Form A (previously DIN 43650) for cable plug type 2508 (see Ordering chart for accessory on p. 4)
Protection class	IP 65 with cable plug
Installation	As required, preferably with actuator upright
Response times¹⁾	0.1 - 4 seconds (depending on orifice and differential pressure)

1) Measured at valve outlet at 6 bar and +20°C. *Opening*: pressure build-up 0 to 90%, *Closing*: pressure relief 100 to 10%

Materials

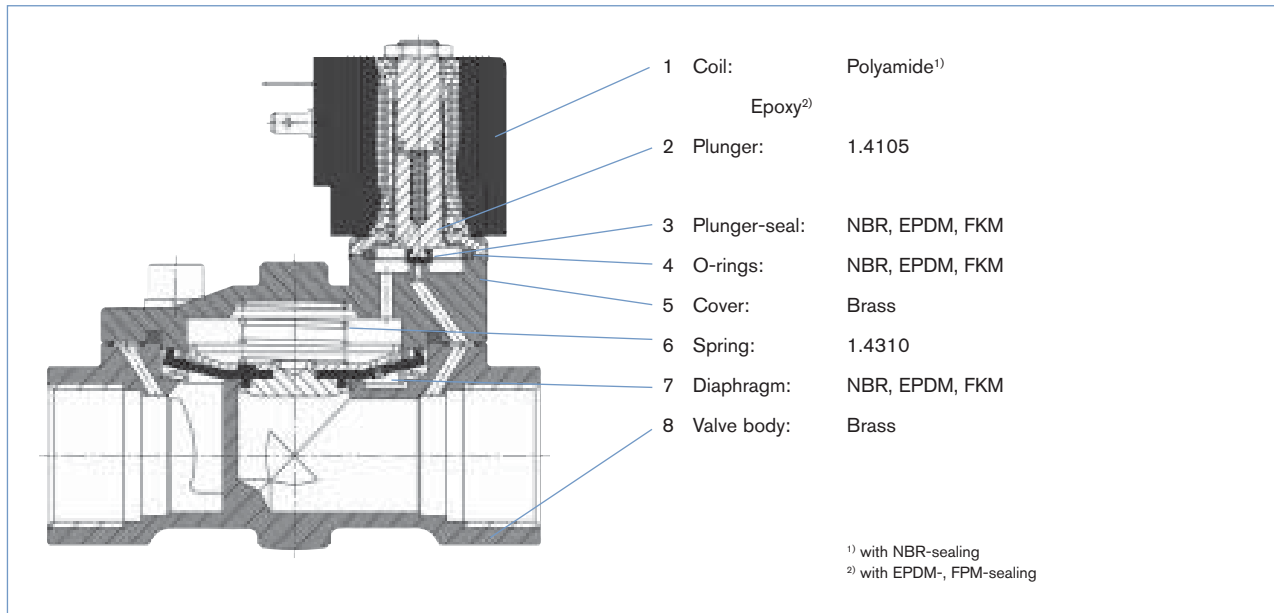

Ordering chart for valves (other versions on requests)

Threaded port, brass body, without cable plug

Circuit function	Port connection	Orifice [mm]	Kv value water [m ³ /h]	Pressure range [bar]	Item no. per voltage/frequency [V/Hz]			
					024/DC	024/50-60	230/50-60	
A 2/2-way valve NC 	Seal material NBR							
	G 1/2	13	4.0	0.2-16	134 317	134 318	134 320	
	G 3/4	20	6.4	0.2-16	134 321	134 322	134 324	
	G 1	25	10.0	0.2-16	134 325	134 326	134 328	
	G 1 1/4	32	20.0	0.2-16	134 329	134 330	134 332	
	G 1 1/2	40	20.0	0.2-16	134 333	134 334	134 336	
	G 2	50	40.0	0.2-16	134 337	134 338	134 340	
	G 2 1/2	65	40.0	0.2-16	134 341	134 342	134 344	
	Seal material FKM							
	G 1/2	13	4.0	0.2-16	134 345	134 346	134 348	
	G 3/4	20	6.4	0.2-16	134 349	134 350	134 352	
	G 1	25	10.0	0.2-16	134 353	134 354	134 356	
	G 1 1/4	32	20.0	0.2-16	134 357	134 358	134 360	
	G 1 1/2	40	20.0	0.2-16	134 361	134 362	134 364	
	G 2	50	40.0	0.2-16	134 365	134 366	134 368	
	G 2 1/2	65	40.0	0.2-16	134 369	134 370	134 372	
	Seal material EPDM							
	G 1/2	13	4.0	0.2-16	134 373	134 374	134 376	
	G 3/4	20	6.4	0.2-16	134 377	134 378	134 380	
	G 1	25	10.0	0.2-16	134 381	134 382	134 384	
	G 1 1/4	32	20.0	0.2-16	134 385	134 386	134 388	
	G 1 1/2	40	20.0	0.2-16	134 389	134 390	134 392	
	G 2	50	40.0	0.2-16	134 393	134 394	134 396	
	G 2 1/2	65	40.0	0.2-16	134 397	134 398	134 400	

Ordering chart for valves (other versions on requests), cont.

Threaded port, brass body, without cable plug

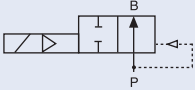
Circuit function	Port connection	Orifice [mm]	Kv value water [m ³ /h]	Pressure range [bar]	Item no. per voltage/frequency [V/Hz]		
					024/DC	024/50	230/50
B 2/2-way valve NO 	Seal material NBR						
	G 1/2	13	4.0	0.2-16	178 873	178 872	178 874
	G 3/4	20	6.4	0.2-16	178 876	178 875	178 877
	G 1	25	10.0	0.2-16	178 879	178 878	178 881
	G 1 1/4	32	20.0	0.2-16	178 883	178 882	178 884
	G 1 1/2	40	20.0	0.2-16	178 886	178 885	178 887
	G 2	50	40.0	0.2-16	178 889	178 888	178 891

Circuit function B: Total height "B1" 2 mm higher than for circuit function A

Please note that the cable plug has to be ordered separately, see Ordering chart for accessory on last page or separate datasheet for Type 2508

Threaded port, brass body and manual override, without cable plug

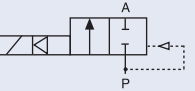
Circuit function	Port connection	Orifice [mm]	Kv value water [m ³ /h]	Pressure range [bar]	Item no. per voltage/frequency [V/Hz]		
					024/DC	024/50-60	230/50-60
A 2/2-way valve NC 	Seal material NBR						
	G 1/2	13	4.0	0.2-16	139 307	139 308	138 314
	G 3/4	20	6.4	0.2-16	139 309	139 310	139 311
	G 1	25	10.0	0.2-16	139 312	139 313	138 801
	G 1 1/4	32	20.0	0.2-16	139 314	139 315	139 316
	G 1 1/2	40	20.0	0.2-16	139 317	139 318	139 319
	G 2	50	40.0	0.2-16	139 320	139 321	139 322
	G 2 1/2	65	40.0	0.2-16	139 323	139 324	139 325

Flange acc. to DIN 2501, grey cast iron flange body, without cable plug

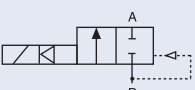
Circuit function	Port connection	Orifice [mm]	Kv value water [m ³ /h]	Pressure range [bar]	Item no. per voltage/frequency [V/Hz]		
					024/DC	024/50-60	230/50-60
A 2/2-way valve NC 	Seal material NBR						
	Flange acc. DIN 2501	25	10.0	0.2-16	134 401	134 402	134 404
		32	20.0	0.2-16	134 405	134 406	134 408
		40	20.0	0.2-16	134 409	134 410	134 412
		50	40.0	0.2-16	134 413	134 414	134 416

Dimensions [mm]

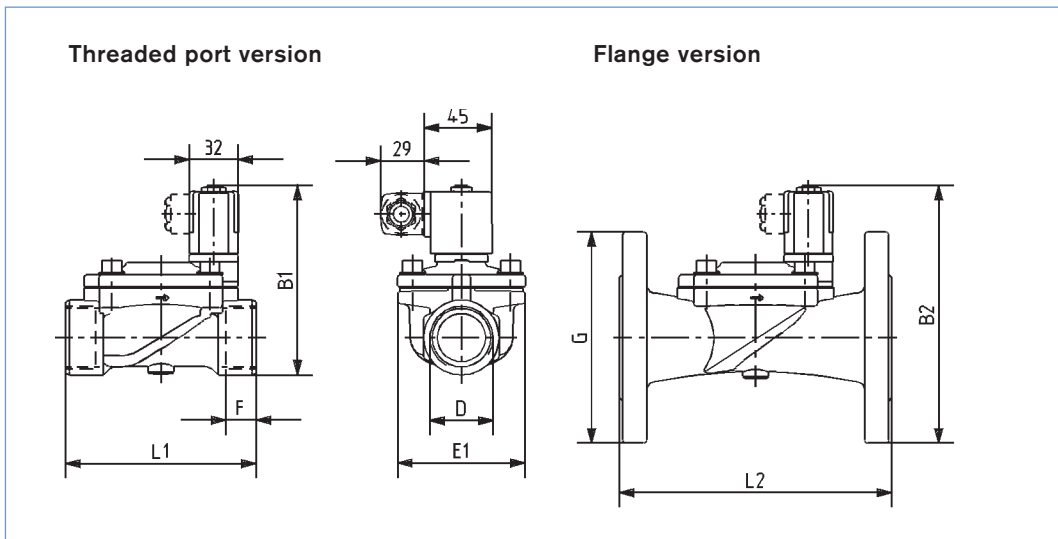

DN	D	Threaded port						Flange			
		B1 Circuit function A	B1 Circuit function B	B1*	E1	F	L1	B2	B2*	G	L2
13	G 1/2	100.0	102.0	110	40	14	65	-	-	-	-
20	G 3/4	107.5	109.5	117.5	60	16	100	-	-	-	-
25	G 1	116.0	118.0	126.0	70	18	115	159.5	169.5	120	160
32	G 1 1/4	126.5	128.5	136.5	85	20	126	171.5	181.5	140	180
40	G 1 1/2	135.5	137.5	145.5	85	22	126	180.5	190.5	150	200
50	G 2	157.2	159.2	167.2	115	24	164	204.7	214.7	165	230
65	G 2 1/2	157.2	159.2	167.2	115	27	180	-	-	-	-

B1* + B2* Version with manual override

i Further versions on request

Approvals
UL/UR/CSA, ATEX-Ex, UL-fire protection, European gas approval

Voltage
110/50, other non-standard voltages

Port connection
NPT, Rc

Ordering chart for accessory

Cable plug Type 2508 according to DIN EN 175301-803 Form A

	Circuitry	Voltage / frequency	Item no.
	None (standard)	0 - 250 V AC/DC	008 376
	further versions see datasheet Type 2508		

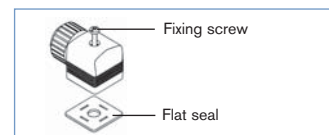

The delivery of a cable plug includes the flat seal and the fixing screw. For other cable plug versions acc. to DIN EN 175301-803 Form A (previously DIN 43650), see separate datasheet Type 2508.

In case of special application conditions, please consult for advice.

Subject to alteration
© Christian Bürkert GmbH & Co. KG

1201/5_EU-en_00891710